

LC Series Software Configuration and System Calibration Manual

Date: 22/12/2014

Issue: 2.8

Firmware Version 2.1.7

Display Type 128x128 graphics

STATUS SCIENTIFIC CONTROLS LTD.

Hermitage Lane Industrial Estate,
Kings Mill Way,
Mansfield,
Notts.

NG18 5ER

England

Tel : 01623 651381

Fax : 01623 421063

Internet : www.status-scientific.com

The LC Series Manuals

The LC range of Environmental Monitoring Systems have a range of manuals covering various aspects of their operation:

- **LC System Installation and Hardware Configuration Manual**
This manual covers all of the hardware aspects of the LC Environmental Monitoring Systems. Each of the component parts of the system is discussed and hardware configuration is explained. Dimensional drawings are included of most of the LC variations.
- **LC Software Configuration and System Calibration Manual**
The operation of the LC system is discussed as well as the software configuration and calibration procedures.

Note: This manual is a generic manual for the latest firmware that is currently in use. While every effort is made to maintain compatibility with older versions certain features and screen references may change when used in conjunction with different firmware versions.

The firmware version is displayed during power up and when the MENU key is pressed in later versions.

Important

Status Scientific Controls strive to continually improve their products in line with customer's requirements and technological advancement. Status Scientific reserve the right to modify the design of the system at any time.

Due to continual improvement not all of the features described within this manual may be available on earlier models, contact Status for further details.

1	CHANGE NOTES	1-3
2	INTRODUCTION	2-4
2.1	Software	2-4
3	SWITCH ON.	3-4
4	OPERATION.....	4-1
4.1	Accessing the System Configuration Menu	4-2
4.2	Alarm Conditions	4-3
4.2.1	Gas Level Alarm.....	4-3
4.2.2	Fault Alarm	4-4
4.2.3	Accepting the Alarm	4-5
4.3	Display Settings.....	4-6
4.3.1	Backlight Time	4-6
4.4	Changing the Password	4-6
5	SOFTWARE CONFIGURATION.....	5-7
5.1	Controller.....	5-9
5.1.1	Start up Delay.....	5-9
5.1.2	Fault Delay	5-10
5.1.3	Fault Sounder.....	5-11
5.1.4	Sounder.....	5-12
5.1.5	Decimal point.....	5-13
5.1.6	Backlight.....	5-13
5.1.7	Font Size	5-14
5.1.8	Password	5-15
5.2	Channel.....	5-16
5.2.1	Alarm Levels.....	5-17
5.2.2	Alarm Delay	5-18
5.2.3	Alarm Hysteresis	5-19
5.2.4	Calibration	5-20
5.3	Set Voltage.....	5-24
5.4	Sensor Type.....	5-25
5.4.1	Sensor Type List.....	5-25
5.4.2	Sensor Type User.....	5-26
5.4.3	Nitrogen Sensor.....	5-31
5.5	Relay Options.....	5-32
5.5.1	Level 3 alarm relays	5-33
5.6	Inhibit	5-34
5.7	View	5-35
5.8	Engineer.....	5-36
5.8.1	Devices	5-37
5.8.2	Analogue output	5-38
5.8.3	Input simulation	5-39
6	SYSTEM RESET	6-40
6.1	Soft Reset.	6-40
7	PC PROGRAMMING SOFTWARE.....	7-41
8	FIRMWARE UPDATE.....	8-46
8.1	Creating a new project.....	8-46
8.2	Programming the LC Controller.	8-53

1 CHANGE NOTES

Date	Changes	Author
23/04/2013	Issue 2.6 Added feature to allow the fault condition to activate the sounder. See section 5.1.3	FK
19/12/2014	Issue 2.7 Added negative range	FK
22/12/2014	Issue 2.8 Expanded details of the linearisation option for oxygen sensors	FK

2 INTRODUCTION

The LC range of Environmental Monitoring Systems has been designed primarily with gas detection in mind. However, the versatility of the range extends its application to other aspects of industry where monitoring of remotely connected sensors is required. The specification allows the use of any sensor that can produce a voltage or current output within a specified range.

2.1 Software

The firmware (software) within each of the control units has had to be carefully designed to allow the full potential of the system to be utilised. In many cases the software is identical between the different control units, but configuration changes have allowed the system to be used for completely different applications.

Incorrect configuration may cause the system to function unsatisfactorily and in extreme cases of incorrect configuration, alarms would not be raised. Status Scientific Controls are happy to offer advice when configuration changes become necessary to ensure a reliable and responsive system is maintained.

3 SWITCH ON.

Before connecting power to the system:

1. Read: LC Series System Installation and Hardware Configuration Manual
LC Series Software Configuration and System Calibration Manual
2. Ensure correct hardware configuration has been performed for each input.
3. Ensure the correct voltage setting has been selected at the power supply.

Switch on the power supply to the system. The firmware version will appear for several seconds on the LCD graphical display. A bar graph will be displayed during the system power up delay setting as follows:

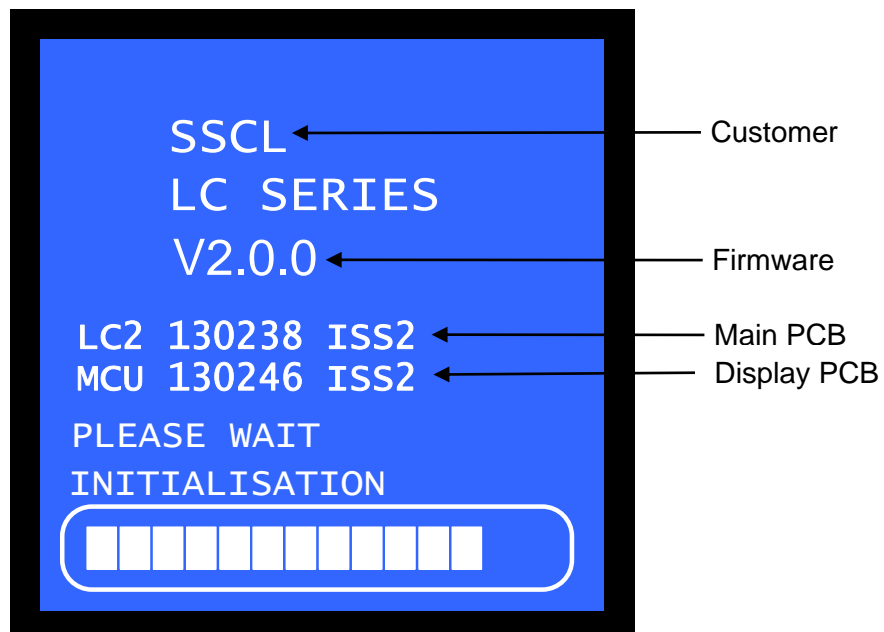

The display will then change to the *System Default Screen*, as shown below. This lists details associated with all configured channels.

The display screen layout will depend upon the Font size selection as shown below:

LC4 Normal screen

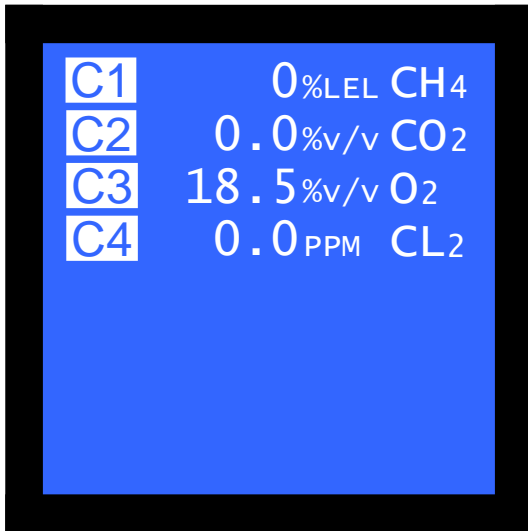

Small font

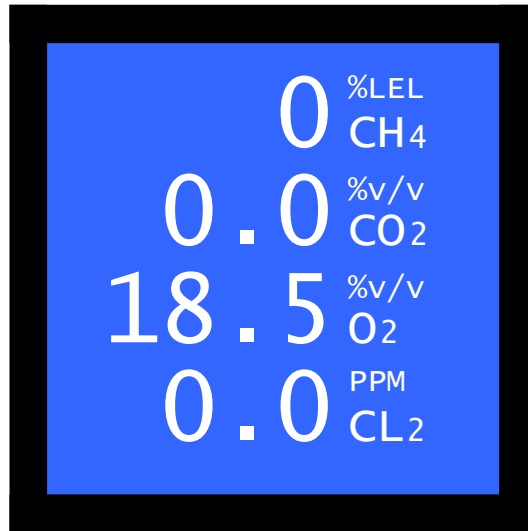

Large font

LC4 Alarm screen

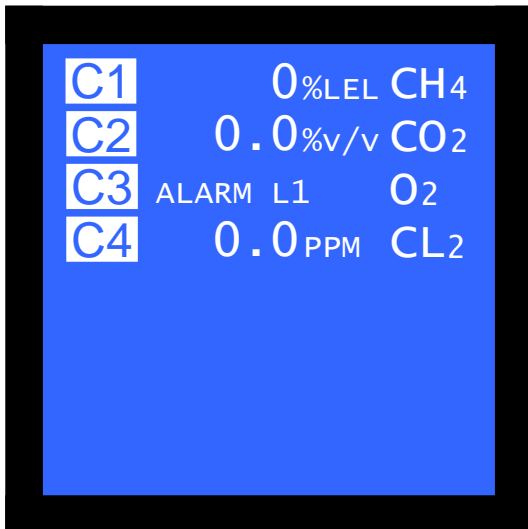

Small font



Large font

LC8 Normal screen

C1	15%LEL	CH4
C2	0.0%v/v	CO2
C3	20.9%v/v	O2
C4	0.0PPM	CL2
C5	0%LEL	CH4
C6	0PPM	CO
C7	2.5ppm	O3
C8	0PPM	NH3

LC8 Alarm screen

C1	ALARM L1	CH4
C2	0.0%v/v	CO2
C3	20.9%v/v	O2
C4	0PPM	CL2
C5	0%LEL	CH4
C6	0PPM	CO
C7	ALARM L123	O3
C8	0PPM	NH3

Note: the large font display is not available for the LC8.

STATUS SCIENTIFIC CONTROLS

LC Series Software Configuration and System Calibration



4 OPERATION

Section 4 discusses the day-to-day operation of the LC Control Unit and some of the features that the average user may wish to use or modify. For detailed software configuration please refer to section 5.

During normal operation, the LC Control Unit does not require user intervention to operate. It will continue to monitor and display readings for all configured channels. User intervention is only required when specific situations are encountered.

The following display and associated push buttons shows an LC8 unit that has all 8 channels configured.

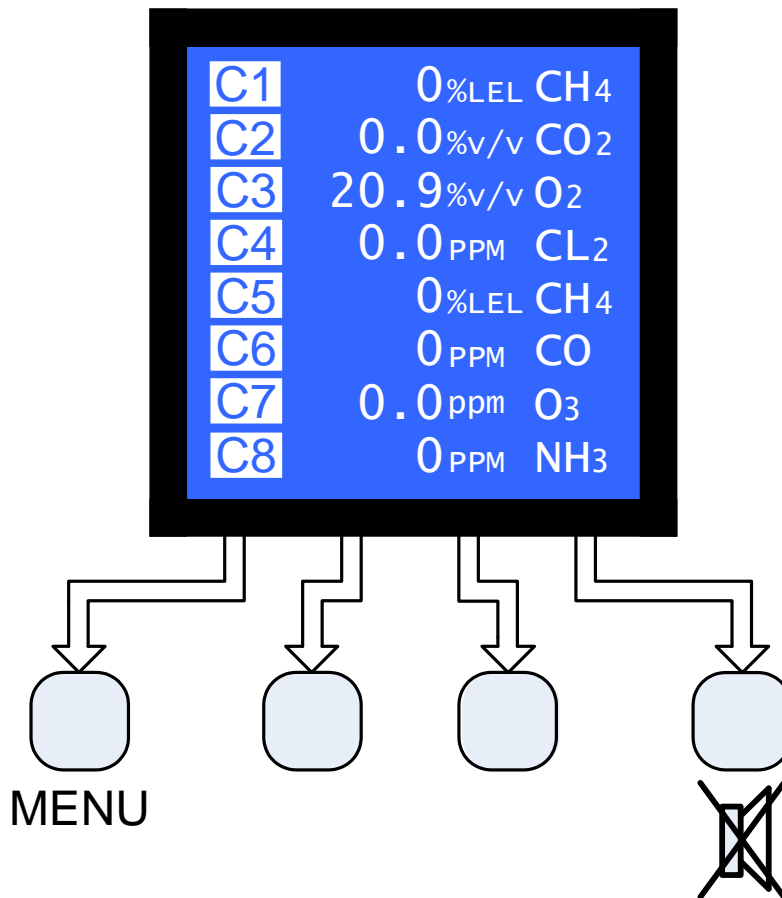

Horizontally there are up to 4 regions, lines 1 to 4, each of which displays the channel information.

Vertically the display is split into 5 regions. Each region gives specific information for each channel.

Note:

The Menu button and the alarm accept buttons are labelled, the other buttons are not identified. The buttons on the front of the LC Control Unit change depending upon the current display function.

4.1 Accessing the System Configuration Menu

All of the features provided by the LC software are accessed from the *System Configuration* menu.

To access the System Configuration Menu:

1. Press menu (from the system default screen).
2. The *Password Entry* screen will appear if the password is set.



3. Enter the correct password and press OK.
4. The default password for the system is 123 (If an incorrect password is entered the system will revert to the standard system default screen).
5. The following screen will be seen when the correct password is entered.

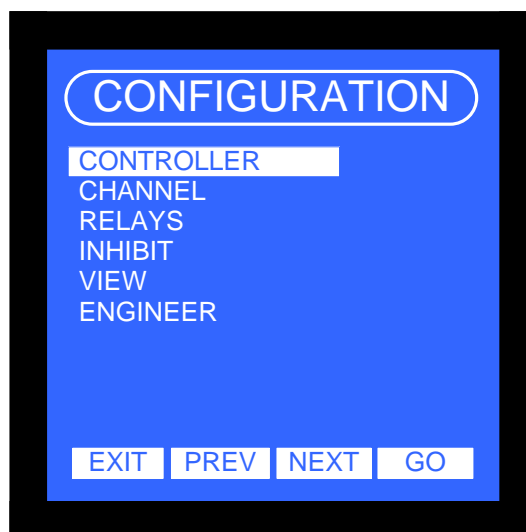

4.2 Alarm Conditions

4.2.1 Gas Level Alarm

Gas level alarms can be of three types

1. Level 1 alarm
2. Level 2 alarm
3. Level 3 alarm

4.2.1.1 Level 1 Alarm

The LC Control unit has stored within its configuration, gas levels at which alarms should be raised.

e.g. Channel 1 may be detecting Methane (0-100% LEL).
Its alarm levels may be set as 15%, 30% and 50% LEL.

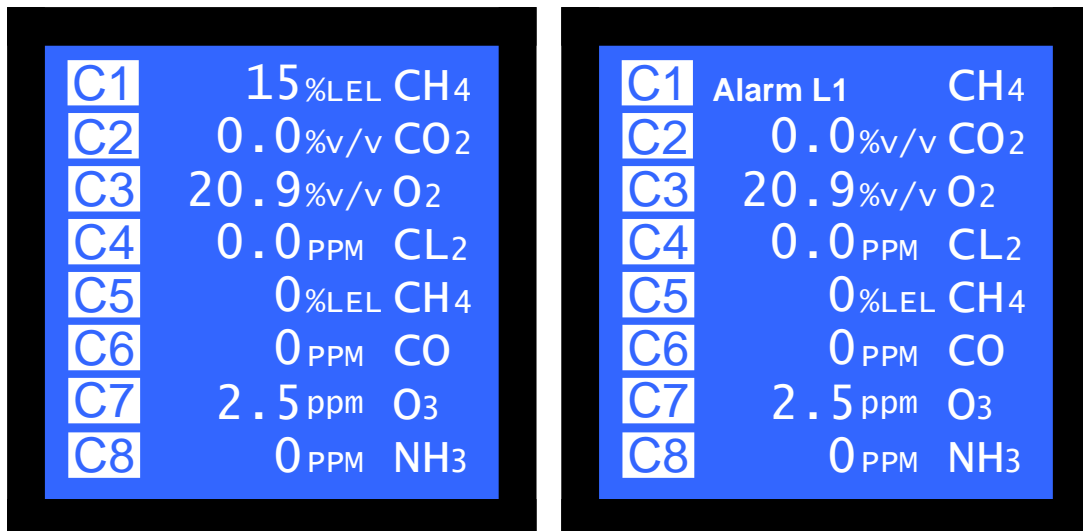

Each time a gas concentration is detected in excess of those set in the alarm levels configuration, in the above example 15% LEL, the LC Control Unit will raise an alarm. The way in which the alarm is raised will depend upon the system configuration and the ancillary sounders and beacons fitted to the system.

Note:

An alarm will be indicated on the display by the word Alarm appearing next to the channel in alarm, the Alarm status will alternate between the alarm levels and the gas reading.

The local Alarm Red LEDs will light to indicate an Alarm condition, regardless of the display mode selected.

STATUS SCIENTIFIC CONTROLS

LC Series Software Configuration and System Calibration



4.2.2 Fault Alarm

The control unit will indicate a fault if a detector head indicates less than 10% of its measuring range (i.e. below 2.4mA signal level).

Any channel that is in a fault condition is detected by the LC Control Unit which generates a fault message, drives the local Yellow LED and activates the fault relay.

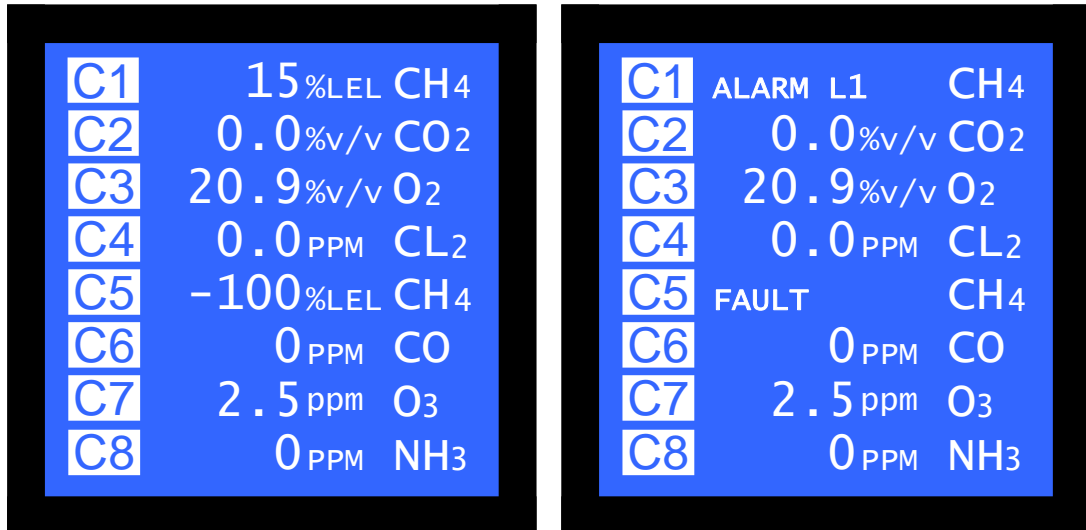

STATUS SCIENTIFIC CONTROLS

LC Series Software Configuration and System Calibration



4.2.3 Accepting the Alarm

If an alarm condition is encountered and: -

The alarm relays are set as non-latching

Pressing alarm accept button ~~✗~~ will allow the sounder to be silenced. When the alarm condition has passed, the relays will reset themselves to their healthy state.

The alarm relays are set as latching

Pressing alarm accept button ~~✗~~ will allow the sounder to be silenced. The Alarm will only be cleared if the ACCEPT Button is pressed and the channel is no longer in an alarm condition.

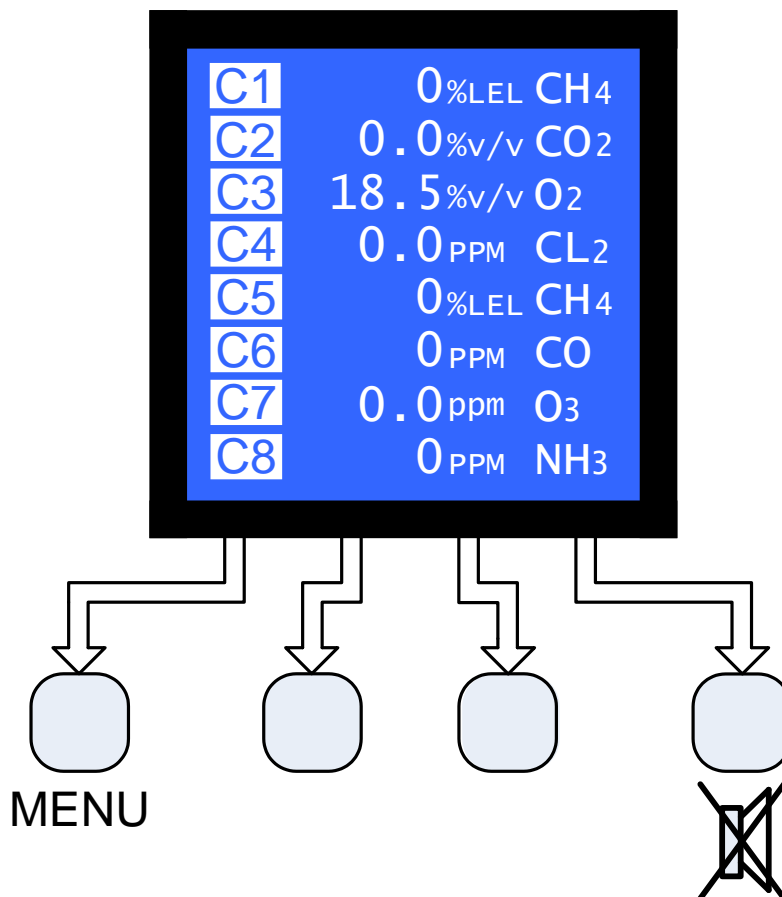

4.3 Display Settings

The LCD display can be configured to display the gas levels using either the decimal point or the comma.

The display can also be set to give an additional message during alarm and fault conditions. This is useful when different languages are used and the text cannot be clearly displayed in the normal 5x8 character size.

The amount of time the backlight remains lit following a key press is also user configurable.

4.3.1 Backlight Time

The LCD display is provided with backlight illumination following a key press. The default backlight-on time is 10 seconds. This time is user configurable between ALWAYS ON, ALWAYS OFF and any time up to 600 seconds.

To change the backlight time:

1. From the *System Configuration* menu select BACKLIGHT and press GO.
2. The *Display Configuration* screen will now be displayed. Use the INCREASE and DECREASE buttons to adjust the backlight-on time. Attempting to decrease the backlight time below 1 second will provide the options of ALWAYS ON and ALWAYS OFF.
3. The system *Warning* screen will now appear warning you that you are making changes to the system configuration. Press YES to save the changes or press NO to abort the changes and return to the main system menu.

4.4 Changing the Password

The *System Configuration* Menu can only be accessed following correct password entry. The default password is '123', however this can be changed.

To change the password:

1. From the *System Configuration* menu select PASSWORD and press GO.
2. The *Password Configuration* screen will now appear.
3. Enter the new password and press OK. The password can contain a maximum of 8 numbers (a minimum of none). **Note:** Pressing EXIT at any time will cancel the current operation.
4. You will then be prompted to confirm the new password. Re-enter the password and press OK.
Note: If a different password is entered at this stage, no settings will be saved and the old password will remain active.
5. The system *Warning* screen will now appear. Press YES to save settings, or NO to abandon changes.
6. The display will now return to the *System Configuration* menu.
Note: Entering no digits will disable the user password.

Note: forgotten password.

The user password can be overridden by the engineer password – contact Status Scientific Controls.

5 SOFTWARE CONFIGURATION.

The software configuration has been made as flexible as possible in order to maintain capability with the many types of sensors available and the wide variety of possible applications. Many options are included within the software to allow the system to be fine tuned to a particular application, and these options may require changing as the system develops (e.g. addition of a sensing channel, change in alarm triggering level).

Before attempting to configure the system ensure:

1. All input modules have the correct hardware configuration.
2. The detector heads have been correctly connected to the appropriately configured input module.

Refer to the '**LC System Installation and Hardware Configuration Manual**'

Most of the features available within the MCU system are configurable in software via the front panel display and keypad. Pressing the 'MENU' button (as indicated by the display) provides access to these features following correct password entry if enabled.

The configuration is consists of several parts:

- 1) Controller configuration
- 2) Channel configuration
- 3) Relays
- 4) Inhibit
- 5) View
- 6) Engineer

This following diagram shows the position of each of the menus available within the LC software.

STATUS SCIENTIFIC CONTROLS

LC Series Software Configuration and System Calibration

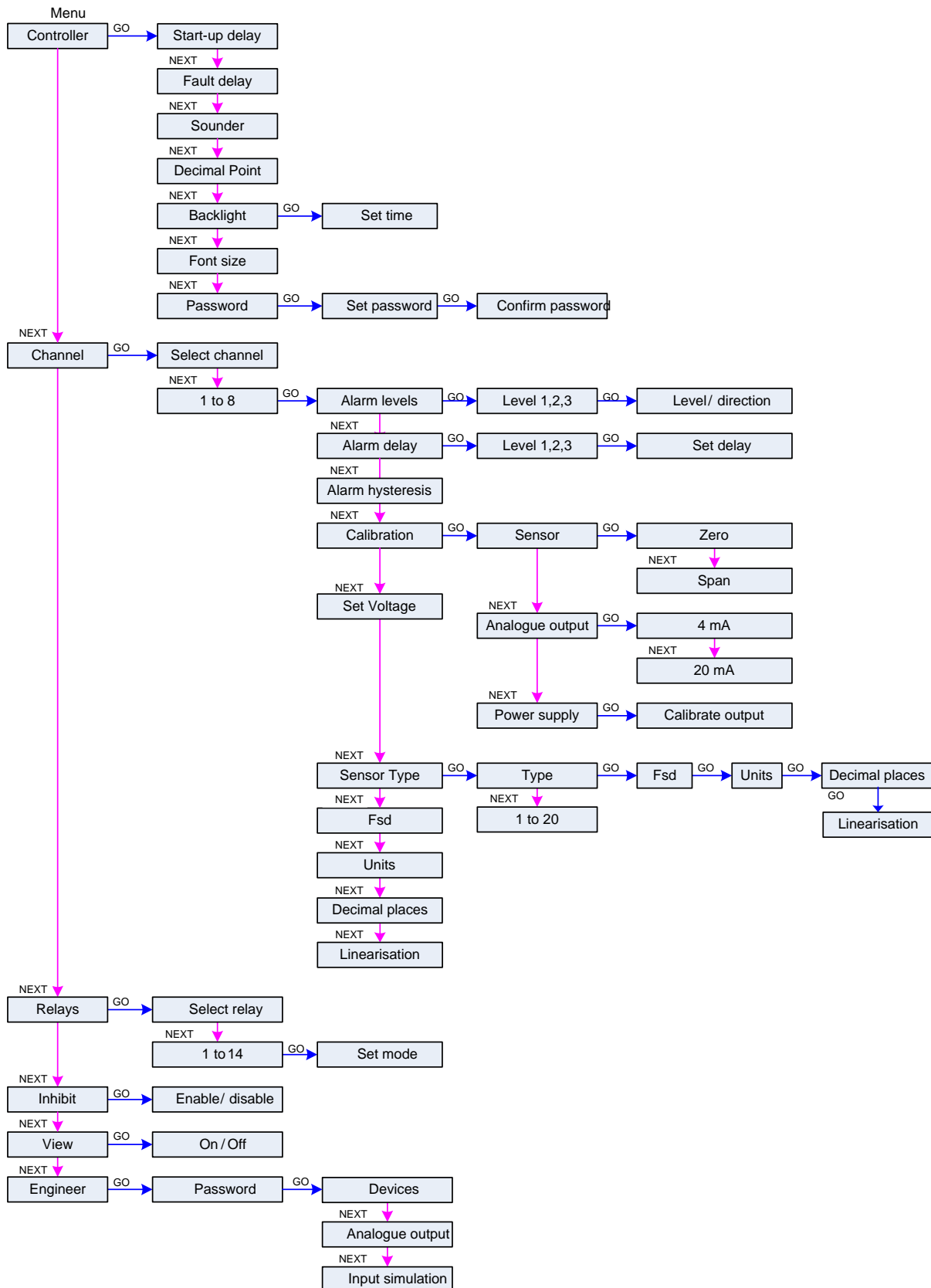

5.1 Controller

The controller menu has 6 menu options as follows:

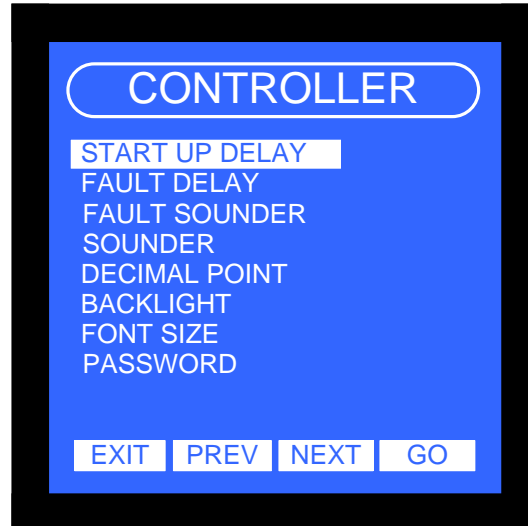

The following section details each menu option.

5.1.1 Start up Delay

This setting allows the LC system to ignore any readings taken following the transition following applying power. The setting can be between 0 and 180 seconds.

1. From the *System Configuration* menu, select CONTROLLER and press GO.
2. Next select the *Start up Delay* menu and press GO.
3. Select the desired time delay using the INCrease and DECrease buttons.

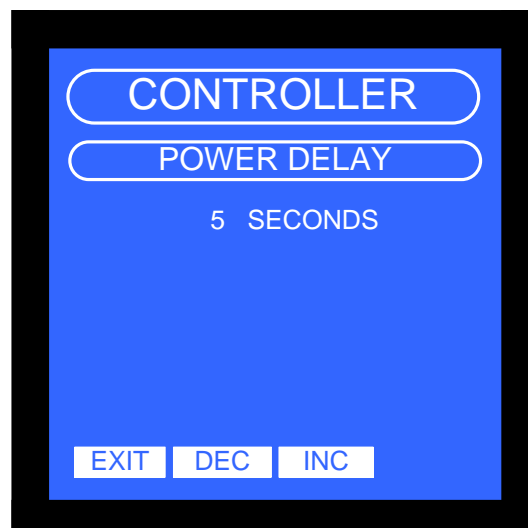

4. Press EXIT once adjustment has been made.
5. The system *Warning* screen will now appear. Press YES to save settings, or NO to abandon changes.
6. Press EXIT, The display will return to the *Start up delay* screen.
7. Press EXIT, The display will now return to the normal screen.

STATUS SCIENTIFIC CONTROLS

LC Series Software Configuration and System Calibration



5.1.2 Fault Delay

This setting allows the LC system to ignore any readings taken that result in a fault condition. The setting can be between 0 and 10 seconds.

1. From the *System Configuration* menu, select CONTROLLER and press GO.
2. Next select the *Start up Delay* menu and press GO.
3. Select the desired time delay using the INCrease and DECrease buttons.

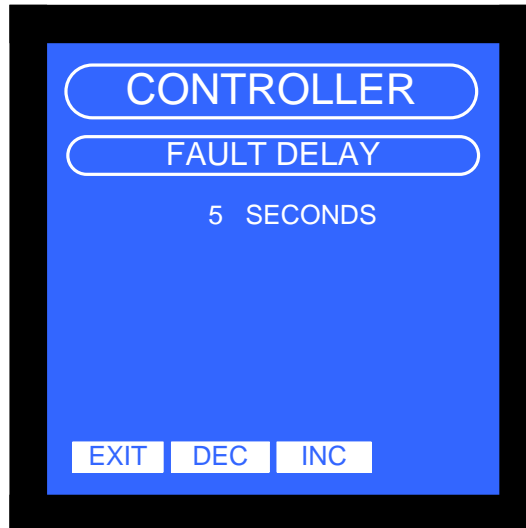

4. Press EXIT once adjustment has been made.
5. The system *Warning* screen will now appear. Press YES to save settings, or NO to abandon changes. The display will return to the *Fault delay* screen.
6. Press EXIT twice, the display will now return to the normal screen.

STATUS SCIENTIFIC CONTROLS

LC Series Software Configuration and System Calibration



5.1.3 Fault Sounder

This option is used to allow the user to trigger the sounder under fault conditions.

- 1) From the *CONTROLLER* menu, select *Fault Sounder* and press GO.
- 2) The *fault sounder setup menu* screen will now be displayed.

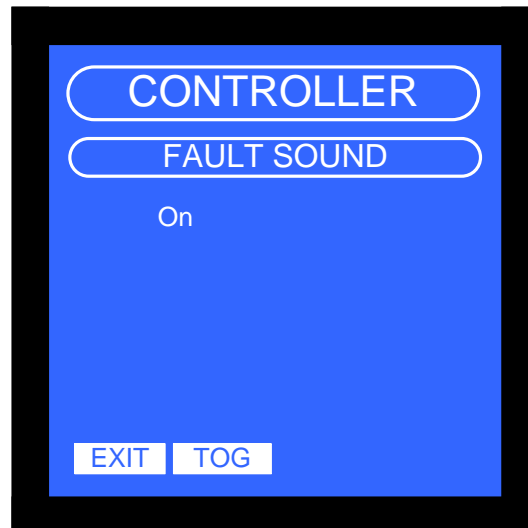

- 3) Use the TOG button to select On to enable the feature and Off to disable the feature.
- 4) Press EXIT leave the setting as it was, the display will now return to the *Controller* menu.
- 5) Press EXIT, if the mode has been changed then the make changes screen will be shown. The display will now return to the *Controller* menu.

STATUS SCIENTIFIC CONTROLS

LC Series Software Configuration and System Calibration



5.1.4 Sounder

This option is used to allow the user to verify that the internal sounder is operational and if necessary adjust its sound level by modifying its frequency of operation.

- 2) From the *ENGINEER* menu, select *Sounder* and press GO.
- 3) The *sounder setup menu* screen will now be displayed.

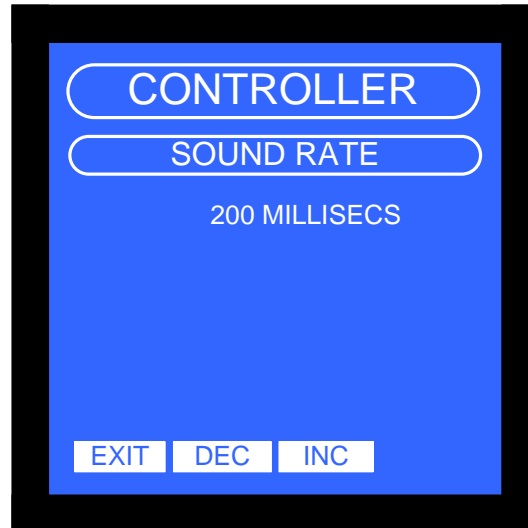

- 4) Use the INC, DEC buttons to select the frequency.
- 5) As the frequency is reduced the setting changes to always off then always on
- 6) Press EXIT leave the setting as it was.
- 7) The display will now return to the *Sounder* menu.
- 8) Press EXIT, The display will now return to the normal screen.

5.1.5 Decimal point

This option is used to allow the user to select the numerical display according to the location.

- 1) From the *ENGINEER* menu, select *Decimal point* and press GO.

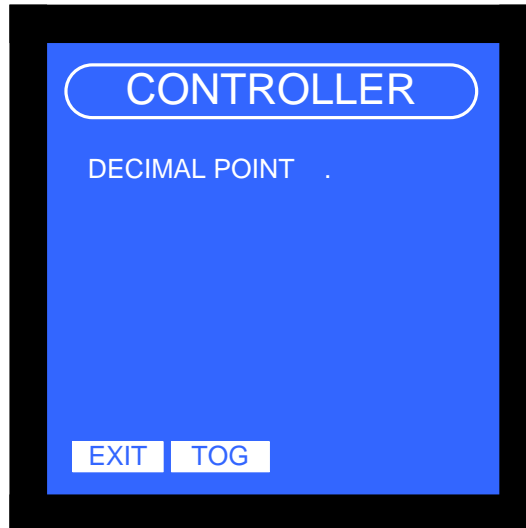

- 2) Use the TOG buttons to select the decimal point or the comma.
- 3) Press EXIT leave the setting as it was.
- 4) The display will now return to the *Decimal point* menu.

5.1.6 Backlight

This option is used to allow the user to set the backlight operation. The backlight can be set to activate when a button is pressed for a pre-determined time. It can also be set to be continuously on or off allowing total flexibility in its use.

- 1) From the *CONTROLLER* menu, select *Backlight* and press GO.



STATUS SCIENTIFIC CONTROLS

LC Series Software Configuration and System Calibration



- 2) Use the INC DEC buttons to select the required time.
- 3) Press TOG to change the mode between timed, always on and 50% dimmed.
- 4) Press EXIT when the desired setting is selected.
- 5) The display will now return to the *Backlight* menu.

Note: some displays require that the backlight is on continuously.

5.1.7 Font Size

This option is used to allow the user to set the font size. If the large size is set then the readings will be maximised at the expense of some display information.

- 1) From the *CONTROLLER* menu, select *font size* and press GO.

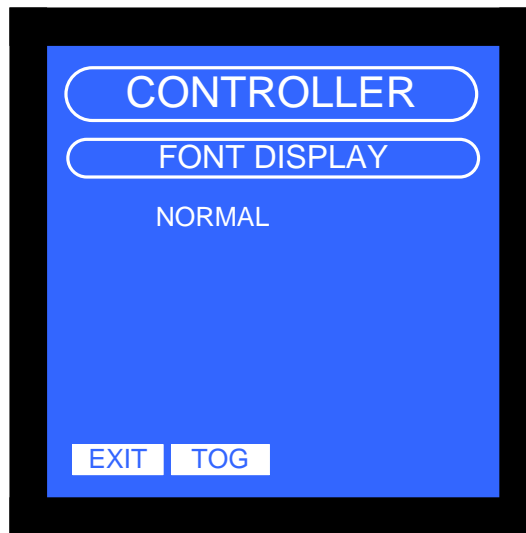

- 2) Use the TOG button to select the required size.
- 3) Press GO when the desired setting has been entered.

5.1.8 Password

This option is used to allow the user to set the user password. The password can be from 0 to 8 digits long and must only contain the numbers 1, 2 and 3.

- 4) From the *CONTROLLER* menu, select *password* and press GO.



- 5) Use the 1, 2 or 3 buttons to select the required password.
- 6) Press GO when the desired number has been entered.
- 7) Confirm the password then press GO.
- 8) The display will now return to the *Password* menu.

Note: the password can be disabled by setting the password to 0, no numbers entered when setting, just press go for new and password confirmation.

5.2 Channel

There are 4 channels available for the LC4 and 8 for the LC8:

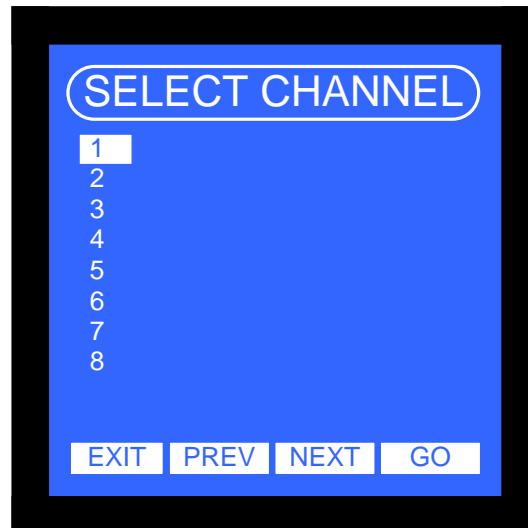

The channel menu has 7 menu options as follows:



The following section details each menu option.

5.2.1 Alarm Levels

Each channel has three configurable alarm levels.

1. From the *Configuration* menu, select CHANNEL and press GO.
2. Select the appropriate channel number and press GO
3. Select ALARM LEVELS and press GO.
4. Select the alarm level 1, 2 or 3 and press GO.
5. The *Alarm Levels* configuration screen will now be displayed.

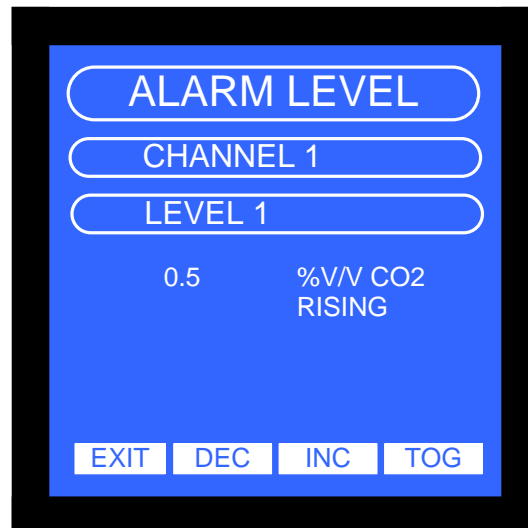

6. Press INCREASE or DECREASE until the desired alarm level is displayed. Press TOG as required to set the alarm as RISING or FALLING.

Note: RISING and FALLING refers to the triggering condition for the relay. A flammable head will read 0%LEL under normal conditions, and we would therefore need to be alerted if the gas levels rise above predetermined levels. In this instance we would set all alarms as RISING alarms. If we consider an oxygen head that would normally indicate oxygen levels of 20.9% we may need to be alerted if the oxygen levels fall below 19.5%, in this instance we would set the alarm as FALLING.

7. Press EXIT once the alarm levels have been selected.
8. The system *Warning* screen will now appear. Press YES to save settings, or NO to abandon changes.
9. The display will now return to the *Alarm Level* menu.
10. Repeat for the next alarm level.

5.2.2 Alarm Delay

Each channel has two configurable alarm delays.

1. From the *System Configuration* menu, select CHANNEL and press GO.
2. Select the appropriate channel number and press GO
3. Select Alarm delay and press GO.
4. Select the alarm level 1, 2 or 3 and press GO.
5. The Alarm *Delay* screen will now be displayed.



6. Press INCrease or DECrease until the desired delay is displayed.
7. Press EXIT.
8. The system *Warning* screen will now appear. Press YES to save settings, or NO to abandon changes.
9. The display will now return to the *Alarm delay level* menu.
10. Repeat for the next alarm level.

STATUS SCIENTIFIC CONTROLS

LC Series Software Configuration and System Calibration



5.2.3 Alarm Hysteresis

Each channel has a hysteresis value associated alarm relays. This setting is used to eliminate relay chatter when the gas level hovers around alarm set point.

1. From the *System Configuration* menu, select CHANNEL and press GO.
2. Select the appropriate channel number and press GO
3. Select HYSTERESIS and press GO.
4. The Hysteresis screen will now be displayed.

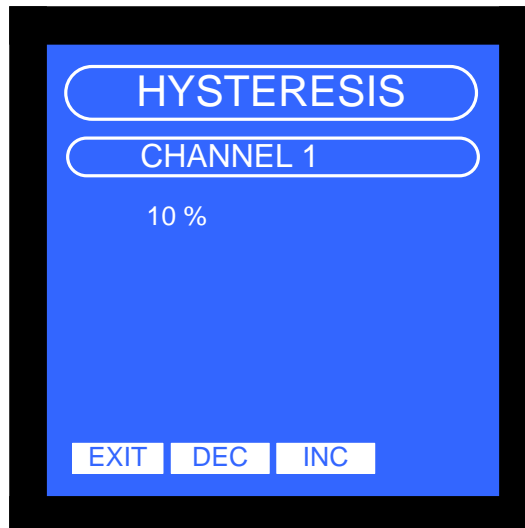

5. Press INCrease or DECrease until the desired hysteresis is displayed.
6. Press EXIT.
7. The system *Warning* screen will now appear. Press YES to save settings, or NO to abandon changes.
8. The display will now return to the *Alarm hysteresis* menu.

5.2.4 Calibration

Each channel has three calibration possibilities, these are:

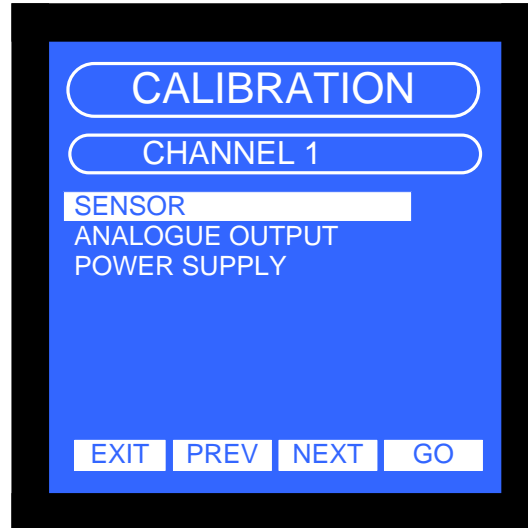

5.2.4.1 Sensor

1. From the System Configuration menu, select CHANNEL and press GO.
2. Select the appropriate channel number and press GO
3. Select Calibration and press GO.
4. Select Sensor and press GO.
5. The following screen will now be displayed.

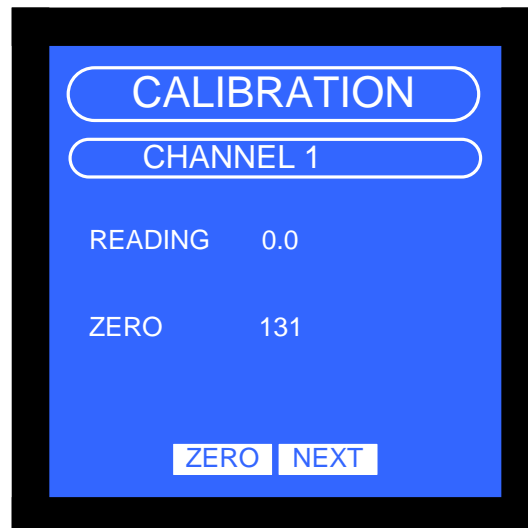

6. Press the ZERO button to zero the sensor. **Make sure that the sensor is in zero gas before performing the zero function.**
7. Press the NEXT button.

Note: The ZERO display shows the raw signal counts for the zero gas level. The ZERO value can be recorded which may be used to determine if the channel input is working correctly.

STATUS SCIENTIFIC CONTROLS

LC Series Software Configuration and System Calibration



8. Apply the test gas. The reading should rise to approximately that of the gas level.
9. When the reading is stable press the SPAN button to calibrate the sensor. The Span button may be pressed repeatedly until the reading and span gas match.
10. Press EXIT. The system *Warning* screen will now appear. Press YES to save settings, or NO to abandon changes.
11. The display will now return to the *Sensor* menu.
12. Press EXIT, The display will now return to the normal screen.

Note: The SPAN display shows the multiplication factor that is applied to the sensor signal to convert the signal to a gas level. The SPAN value can be recorded which may be used to determine if the channel input is working correctly.

STATUS SCIENTIFIC CONTROLS

LC Series Software Configuration and System Calibration



5.2.4.2 Analogue output

Connect a multimeter to the analogue output, select an appropriate range depending upon the channel configuration.

1. From the System Configuration menu, select CHANNEL and press GO.
2. Select the appropriate channel number and press GO
3. Select Calibration and press GO.
4. Select Analogue output and press GO.
5. The following screen will now be displayed.



6. Press the INCrease DECrease buttons to adjust the output to 4 mA or 1V.
7. Press the NEXT button.



8. Press the INCrease DECrease buttons to adjust the output to 20 mA or 5V.
9. Press the NEXT button.
10. The system *Warning* screen will now appear. Press YES to save settings, or NO to abandon changes.
11. The display will now return to the *Analogue output* menu.

STATUS SCIENTIFIC CONTROLS

LC Series Software Configuration and System Calibration



12. Press EXIT, The display will now return to the normal screen.

5.2.4.3 Power supply

Each channel has a variable power supply that can be adjusted between 0 and 24 volts. This allows the user to set the supply to match the external device.

The power calibration voltage is displayed on the display during set up. This voltage is set to the actual measured voltage.

Note: it may be necessary to measure the voltage at the device if it a long way from the control unit.

Connect a multimeter to the variable PSU output, select a range that will display up to 30V dc.

1. From the System Configuration menu, select CHANNEL and press GO.
2. Select the appropriate channel number and press GO
3. Select Calibration and press GO.
4. Select Power supply and press GO.
5. The following screen will now be displayed.

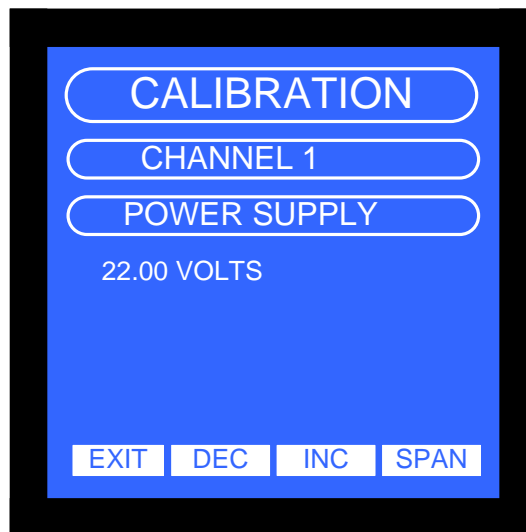

6. Press the INCrease / DECrease buttons to adjust the displayed reading output to match the measured level.
7. Press the SPAN button when the display matches the measured level.
8. Press the EXIT button.
9. The system *Warning* screen will now appear. Press YES to save settings, or NO to abandon changes.
10. The display will now return to the Calibration / *Power supply* menu.
11. Press EXIT until the display returns to the normal screen.

5.3 Set Voltage

Each channel has a variable power supply that can be adjusted between 0 and 24 volts. This allows the user to set the supply to match the external device.

The power supply voltage is displayed on the display during set up, however the displayed voltage is dependent upon the load connected to the supply and may not read exact. The display voltage can be calibrated for any given load, see section 5.2.4.3.

Note: it may be necessary to measure the voltage at the device if it a long way from the control unit.

Connect a multimeter to the variable PSU output and select a range that will display up to 30V dc.

- 1 From the System Configuration menu, select CHANNEL and press GO.
- 2 Select the appropriate channel number and press GO
- 3 Select SET VOLTAGE and press GO.
- 4 The following screen will now be displayed.

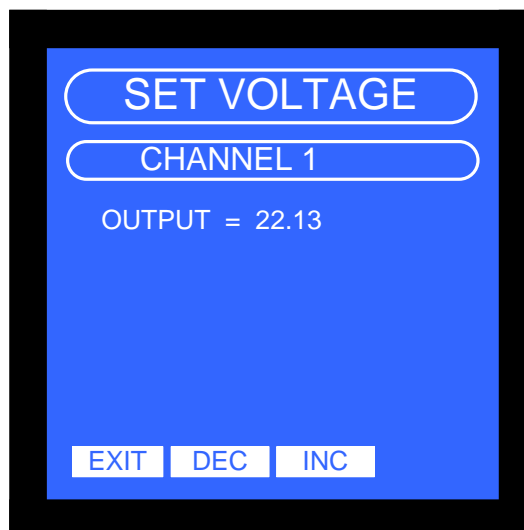

- 5 Press the INCRease or DECcrease button to adjust the output to the desired level as shown on the multimeter.
- 6 Press the EXIT button.
- 7 The system *Warning* screen will now appear. Press YES to save settings, or NO to abandon changes.
- 8 The display will now return to the SET VOLTAGE menu.
- 9 Press EXIT until the display returns to the normal screen.

5.4 Sensor Type

This option allows the user to change the type of sensor each channel is monitoring (as a result of sensor change).

Any change in settings using this menu option must be followed by a calibration.

5.4.1 Sensor Type List

From the *System Configuration* menu, select CHANNEL and press GO.

Select the appropriate channel number and press GO.

From the *Channel Options* screen select SENSOR TYPE and press GO.

A *Sensor Selection* screen will be displayed. Select the appropriate sensor type by using the PREVIOUS and NEXT buttons.

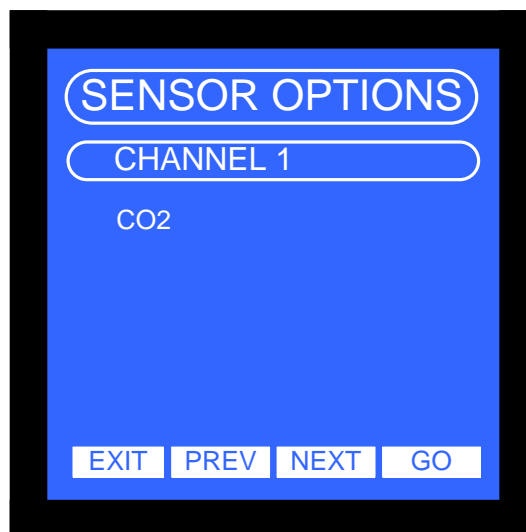

Press GO

5.4.2 Sensor Type User

This option allows the user to provide a CUSTOM defined sensor type that is not available from the standard list.

Any change in settings using this menu option must be followed by a calibration.

From the *System Configuration* menu, select CHANNEL and press GO.

Select the appropriate channel number and press GO.

From the *Channel Options* screen select SENSOR TYPE and press GO.

A *Sensor Selection* screen will be displayed. Select the user type by using the PREVIOUS and NEXT buttons.

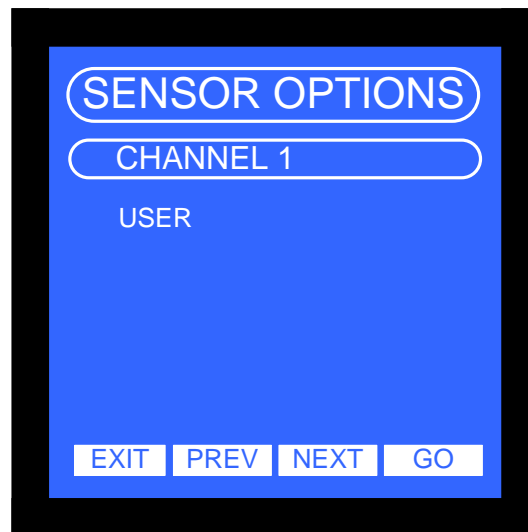

Press GO

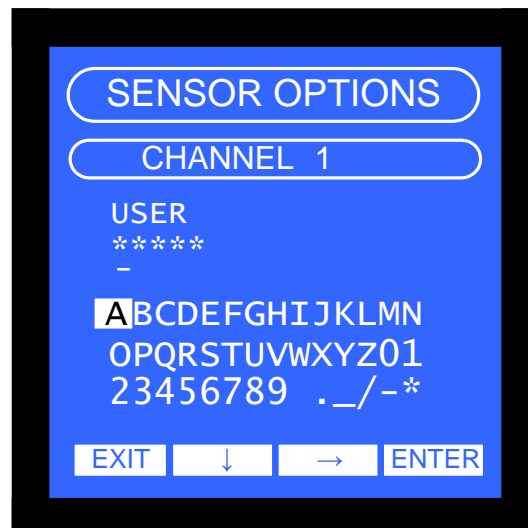

Use the arrow keys to select the desired character then press ENTER. The next character position will be automatically selected, shown by the underscore character, _. All characters must be entered as there is no provision to skip characters. When the desired text has been entered press Exit to move on to the next menu option.

Note: the numerical characters will be displayed smaller than the other characters, i.e. C3H8 will be displayed as C3H8

STATUS SCIENTIFIC CONTROLS

LC Series Software Configuration and System Calibration



The *Sensor zero* screen will now be displayed. This screen allows the user to choose the operating range of the sensor. The default values for the sensor will be displayed.

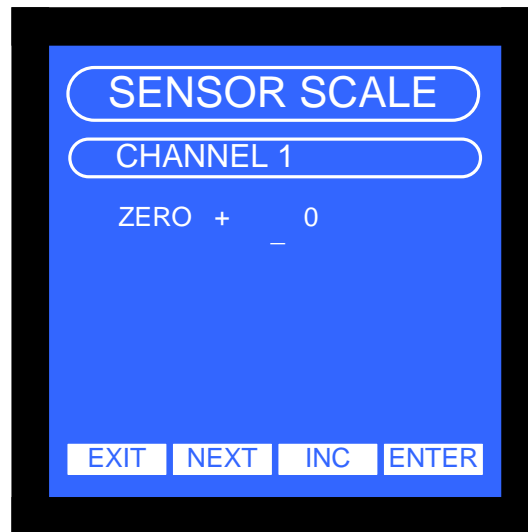

The zero has a range setting of -9999 to +9999. Editing is carried out on a digit by digit basis.

Edit the FSD as follows:

INC – increases the digit from 0 to 9, + or – for digit 1

NEXT – selects the next digit to edit, a maximum of 5 digits are available

ENTER – changes the current setting to the one that is displayed.

EXIT – exit the FSD edit routine

Important: It is vital that the zero values selected at the control unit is identical to that of the detector head. The zero value is the reading that corresponds to the head drawing a current of 4mA.

STATUS SCIENTIFIC CONTROLS

LC Series Software Configuration and System Calibration



The *Sensor Scale* screen will now be displayed. This screen allows the user to choose the operating range of the sensor. The default values for the sensor will be displayed.

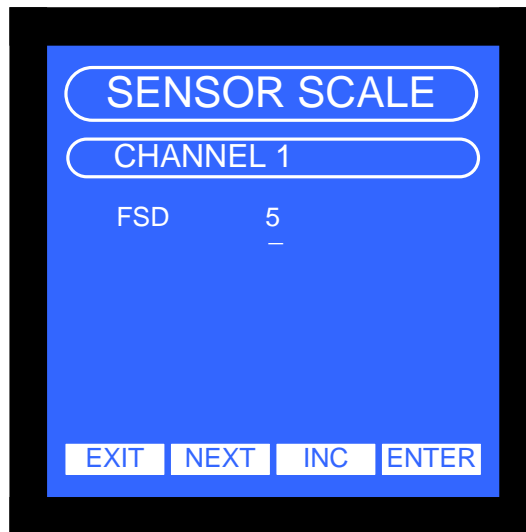

The FSD has a maximum setting of 9999. Editing is carried out on a digit by digit basis.

Edit the FSD as follows:

INC – increases the digit from 0 to 9, + or – for digit 1

NEXT – selects the next digit to edit, a maximum of 5 digits are available

ENTER – changes the current setting to the one that is displayed.

EXIT – exit the FSD edit routine

Important: It is vital that the FSD values selected at the control unit is identical to that of the detector head. The FSD value is the reading that corresponds to the head drawing a current of 20mA.

STATUS SCIENTIFIC CONTROLS

LC Series Software Configuration and System Calibration



Press GO once the correct sensor range has been selected.

The *Sensor Units* screen will now be displayed. This screen allows the user to choose the units of the sensor.

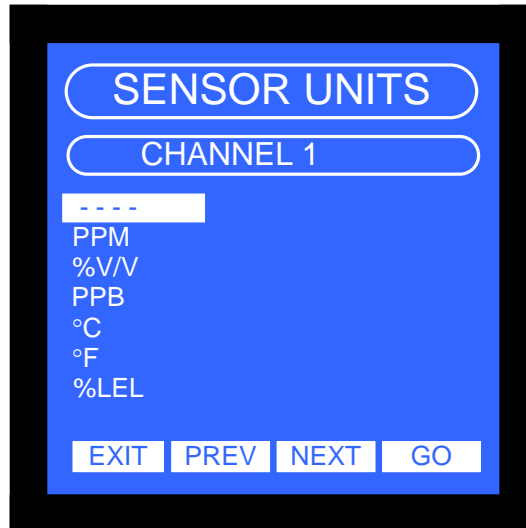

Press GO once the correct sensor units have been selected. The following screen is displayed:



Select the appropriate display type by using the PREVIOUS and NEXT buttons then press GO.

The system *Warning* screen will now appear. Press YES to save settings, or NO to abandon changes.

The display will now return to the *Sensor Type* menu.

Press EXIT, The display will now return to the normal screen.

A linearisation curve fit can be applied for oxygen sensors, the following screen will be shown:

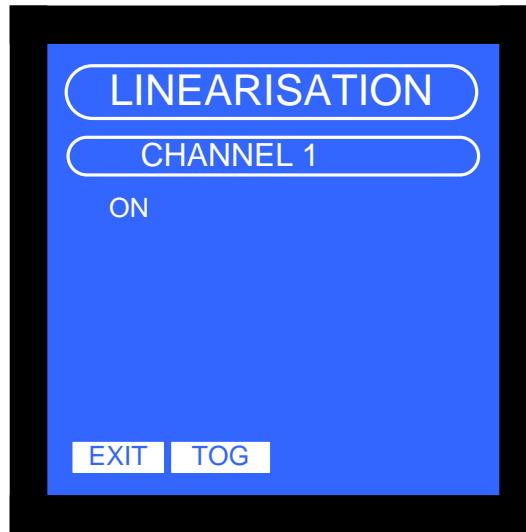

A calibration must now be performed.

Note: the linearisation takes the form as detailed for the city technology oxygen sensor.

Extract from data sheet

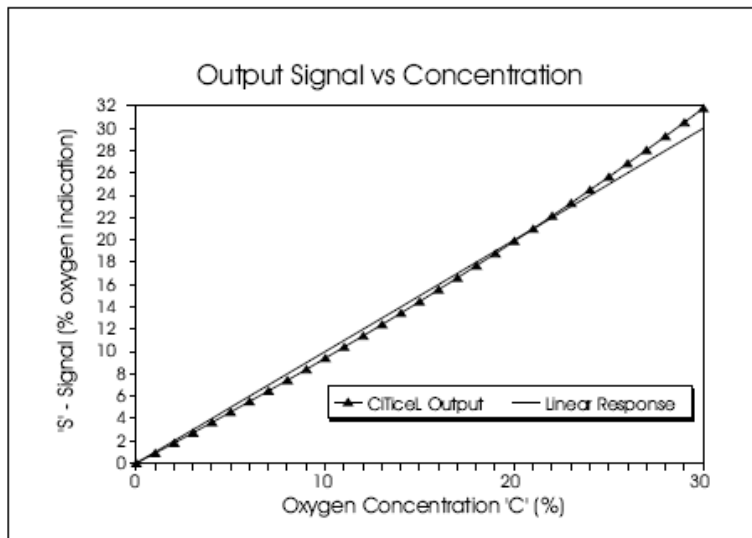

The output signal of an Oxygen CiTiceL follows the relationship:

$$S = K \log_e 1/(1-C)$$

where:

- S = Output signal;
- C = Fractional oxygen concentration;
- K = a constant for the sensor.

Note: If this option is used with an instrument that displays the readings then the LC display and the instrument display will not match the readings throughout the range.

5.4.3 Nitrogen Sensor

The software can be configured for a virtual sensor for nitrogen gas. When the channel is set to nitrogen, N₂, the nitrogen level is calculated by subtracting the previous channel readings from 100.

All channels must be set to %v/v with 1 decimal place. A typical display is shown below

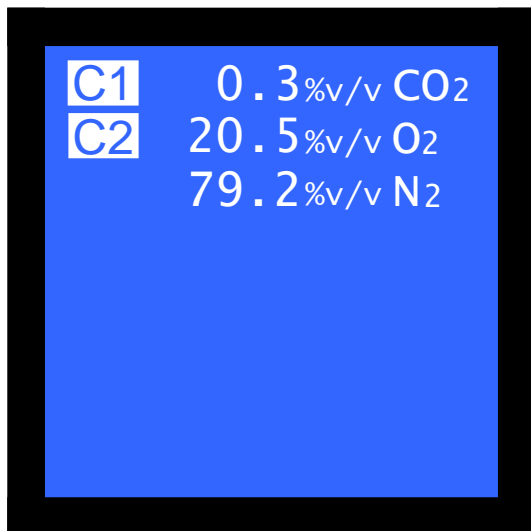

Normal Font

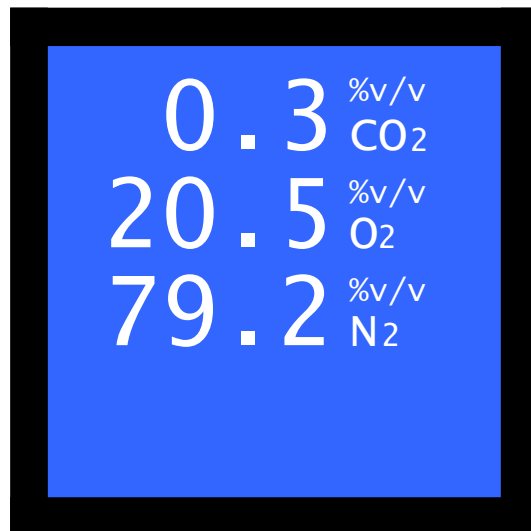

Large Font

Note: any channel that reads negative, inhibited or the units are set to something other than %v/v will be treated as 0% reading.

5.5 Relay Options

Each relays has user configurable options available to them.

1. From the *System Configuration* menu, select Relays and press GO.



2. Select the appropriate relay using the PREVIOUS and NEXT buttons and press GO



Notice that the arrow key points to the setting that will be changed when TOG is pressed. Pressing NEXT will move the arrow to the next option.

3. Press EXIT when the desired options are set.
4. The system *Warning* screen will now appear. Press YES to save settings, or NO to abandon changes.
5. The display will now return to the *Relay* menu.
6. Press EXIT, The display will now return to the normal screen.

STATUS SCIENTIFIC CONTROLS

LC Series Software Configuration and System Calibration



The relay options are:

MODE (N/D or N/E)

This refers to the state of the relay under normal (no-alarm) conditions.

i.e. N/D Normally de-energised.

N/E Normally energised.

ENABLED (YES or NO)

Refers to whether the relay will change state if an alarm condition is encountered.

LATCH (YES or NO)

Latching/non-latching refers to how the relay reacts to an alarm condition. If a relay is set as non-latching, the relay will operate when an alarm condition is encountered and the relay will return to its normal state once the condition has passed. If the relay is set as latching then the relay will not return to its normal state until the alarm condition has passed AND the alarm has been accepted at the LC keypad.

5.5.1 Level 3 alarm relays

Relay 3 for Level 3 alarms don't individually exist but are combined to form 1 common level 3 relay. This results in only 1 option being made available – the latching function.

- 1) From the *System Configuration* menu, select Relays and press GO.
- 2) Select the appropriate relay using the PREVIOUS and NEXT buttons and press GO



Notice only the LATCH option setting that will be changed when TOG is pressed.

- 3) Press EXIT when the desired options are set.
- 4) The system *Warning* screen will now appear. Press YES to save settings, or NO to abandon changes.
- 5) The display will now return to the *Relay* menu.
- 6) Press EXIT, The display will now return to the normal screen.

5.6 Inhibit

The Inhibit function allows channels to be disabled. Channels may require disabling for several reasons e.g. a fault occurring on a channel, to allow sensor replacement within the detector head, to allow detector head calibration.

A disabled channel entering into a fault or alarm condition will result in no action being taken i.e. no relays will operate. The disabled channel will appear on the *System Default* screen with 'OFF' flashing next to the current reading. The current reading is still displayed to assist with fault finding. All other active channels will continue to operate normally.

The analogue output from the inhibited channel will go into fault mode.
i.e. output will equal <2mA or <0.5V depending on mode

1. From the *System Configuration* menu, select INHIBIT and press GO.
2. The *Inhibit Options* screen will now be displayed.

Note: Pressing Exit at any time will return the display to the System Configuration menu.



3. Using the NEXT button select the first channel to be inhibited, press TOGGLE. A 'yes' or 'no' will appear next to the channel indicating selection.
4. Press EXIT when all of the channels requiring inhibiting have been selected.
5. The system *Warning* screen will now appear. Press YES to save settings, or NO to abandon changes.
6. The display will now return to the *Inhibit Channel* menu.
7. Press EXIT, The display will now return to the normal screen.

Important:

Do not forget to enable the channel once fault rectification or sensor replacement has been performed.

5.7 View

The View function allows channels to be hidden. Channels may require hiding for several reasons e.g. only 3 sensors fitted to a 4 channel system.

A channel that is hidden will still function as an active channel unless it is inhibited.

- 1) From the *System Configuration* menu, select INHIBIT and press GO.
- 2) The *Inhibit Options* screen will now be displayed.

Note: Pressing Exit at any time will return the display to the System Configuration menu.

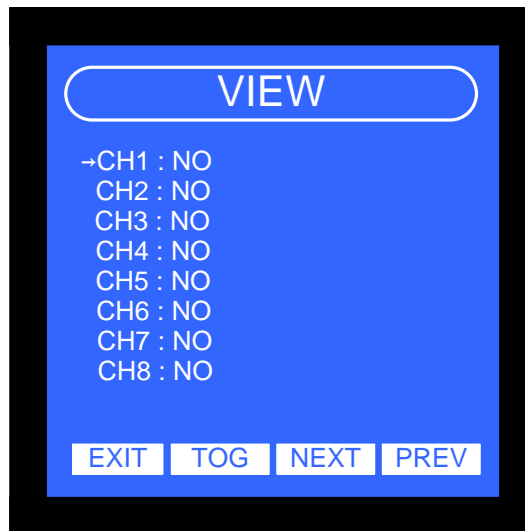

- 3) Using the NEXT button select the first channel to be inhibited, press TOGGLE. A 'yes' or 'no' will appear next to the channel indicating selection.
- 4) Press EXIT when all of the channels requiring inhibiting have been selected.
- 5) The system *Warning* screen will now appear. Press YES to save settings, or NO to abandon changes.
- 6) The display will now return to the *Inhibit Channel* menu.
- 7) Press EXIT, The display will now return to the normal screen.

5.8 Engineer

This menu is provided to allow Status Scientific Controls personnel or trained personnel to verify the correct operation of the hardware. This option is accessed via the ENGINEER option in the main menu screen. An additional password is required to enter this menu option.

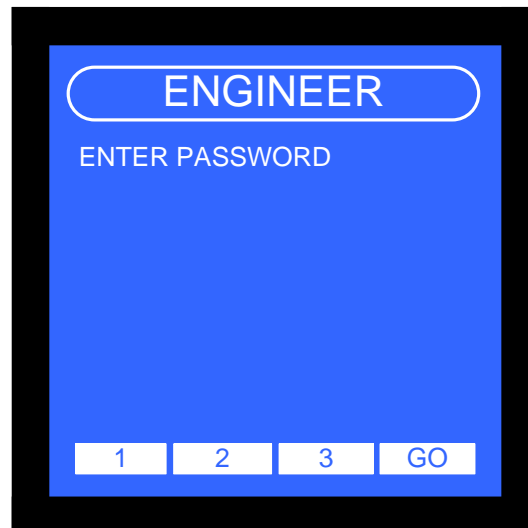

The password can be obtained from Status Scientific Controls.

There are three engineer options as seen on the following screen:

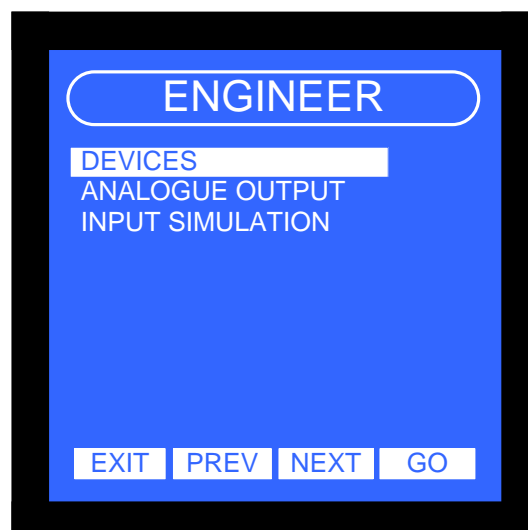

5.8.1 Devices

This option is used to allow the user to verify that the relays, sounder and indicators are operating correctly.

- 1) From the *ENGINEER* menu, select sound and press GO.
- 2) The *Hardware test menu* screen will now be displayed.

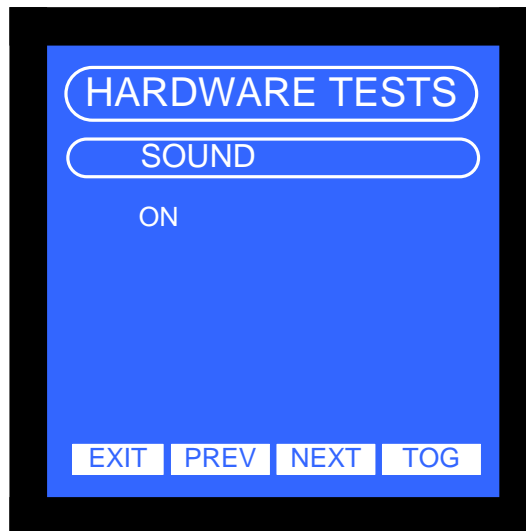

- 3) Use the PREV, NEXT buttons to set the desired option:
Sound, L1 Led , L2 Led RLY FAULT etc
- 4) Use the TOG button to activate, deactivate the selected option.
- 5) Press EXIT when the tests have been completed. The display will now return to the *ENGINEER* menu.
- 6) Press EXIT twice, the display will now return to the normal screen.

5.8.2 Analogue output

This option is used to allow the user to verify that the analogue output is working correctly. Connect a multimeter to the analogue output.

- 1) From the *ENGINEER* menu, select ANALOGUE OUTPUT and press GO.



- 2) Use the NEXT button to select the channel.
- 3) Use the INC, DEC buttons to increase, decrease the analogue output level.
- 4) Press EXIT when the tests have been completed.
- 5) The display will now return to the *ENGINEER* menu.

5.8.3 Input simulation

This option is used to allow the user simulate a sensor output under normal operation.

Note: if the simulated sensor output rises above an alarm set point then the system will generate alarm etc as per the system configuration.

- 1) From the *ENGINEER* menu, select *Input simulation* and press GO.



- 2) Use the NEXT button to select the channel.
- 3) Use the INC, DEC buttons to increase, decrease the sensor level.



- 4) Press EXIT when the tests have been completed.
- 5) The display will now return to the *Input simulation* menu.

6 SYSTEM RESET

The system may be reset by removing power waiting for 20 to 30 seconds then re-applying power.

6.1 Soft Reset.

The LC series control units can be reset without removing the power. This is achieved by pressing a combination of buttons on the front panel as follows:

- 1) Press and hold the two un-marked buttons.
- 2) Hold the buttons until the display shows the following screen.

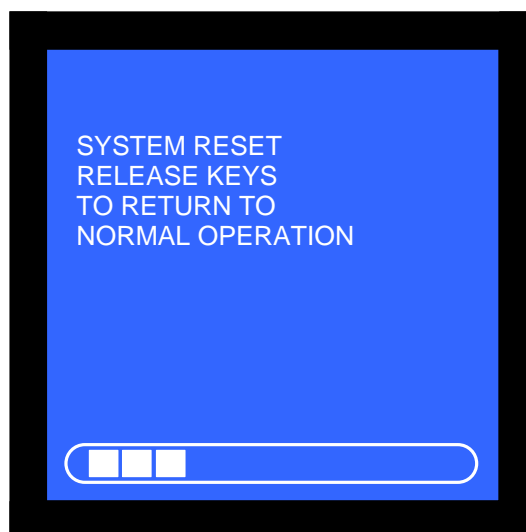

Note: the bar graph shows the remaining time to reset the LC Controller, if the keys are released before the bar graph reaches the end then the controller will return to normal operation.

7 PC PROGRAMMING SOFTWARE.

Install the programming software contained on the CD.

Execute <Drive>:\HewInstMan.exe in the CD for installation according to the instruction displayed on the screen.



Select Installation.

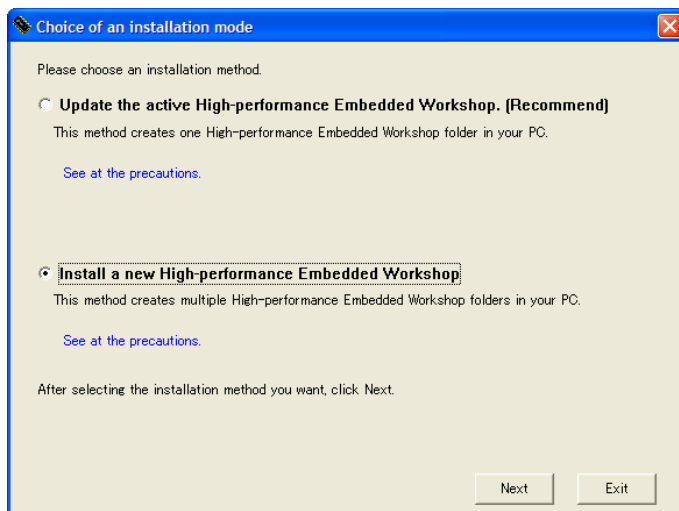

Select 'Install a new High-performance Embedded Workshop' then press Next.

STATUS SCIENTIFIC CONTROLS

LC Series Software Configuration and System Calibration

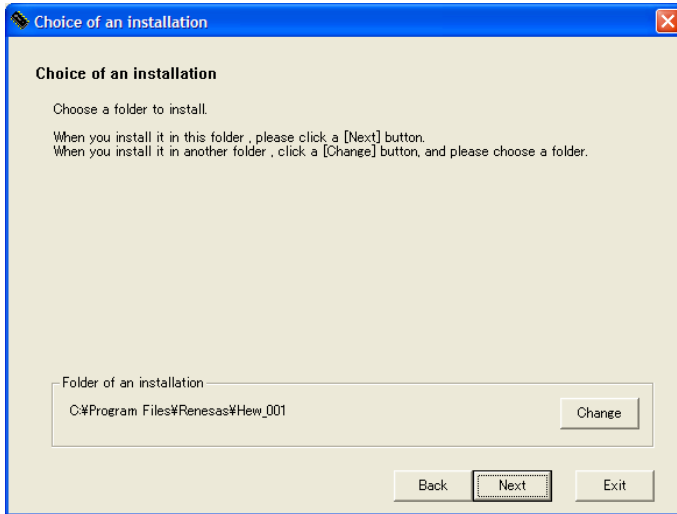

Press Next.

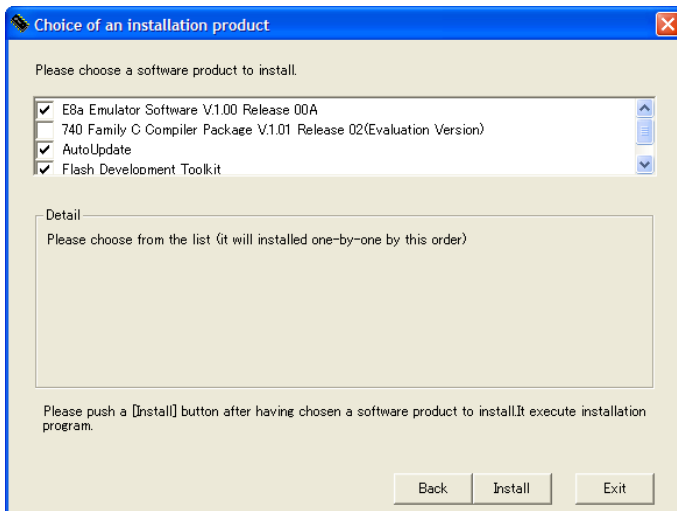

De-select '740 Family.....' then press Install.

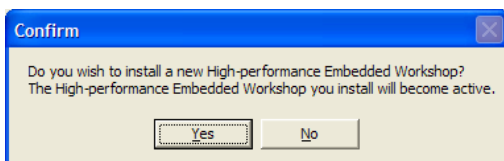

Press Yes

If the following screen is shown

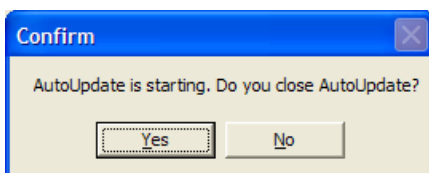

Press Yes

STATUS SCIENTIFIC CONTROLS

LC Series Software Configuration and System Calibration

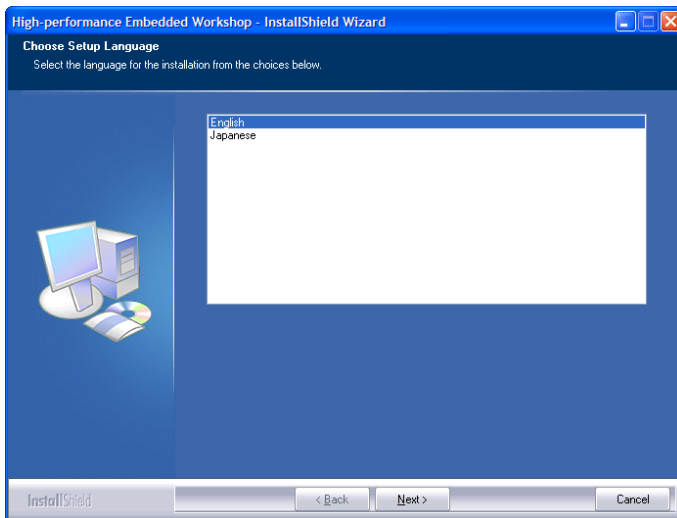

Select the language then press Next

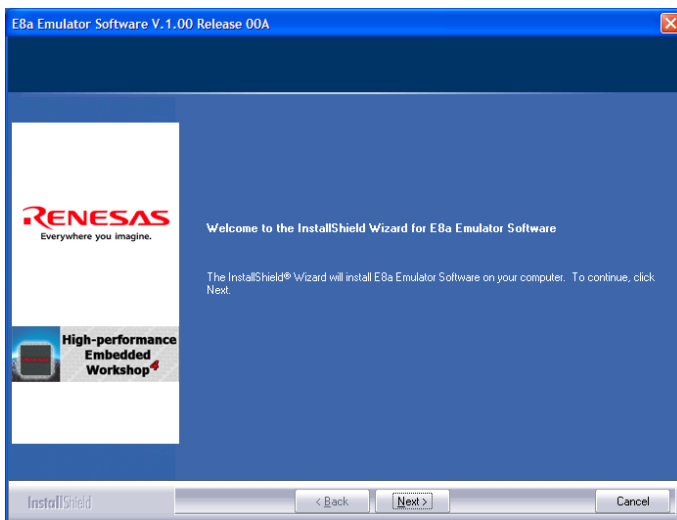

Select Next



Read the terms and conditions then select Yes

STATUS SCIENTIFIC CONTROLS

LC Series Software Configuration and System Calibration

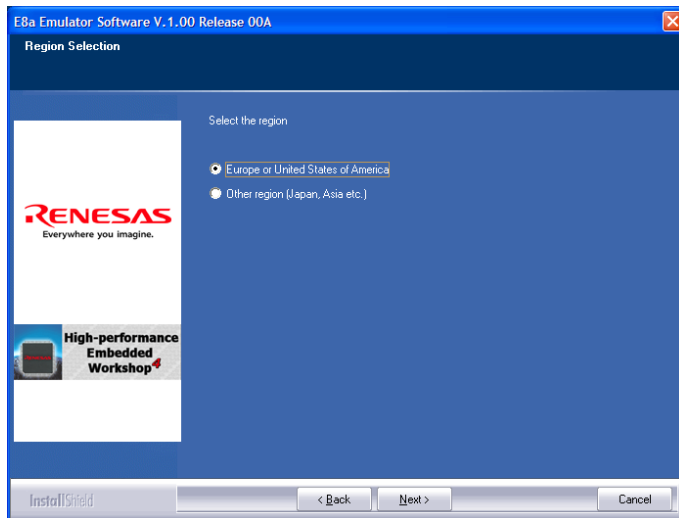

Select the region then press Next

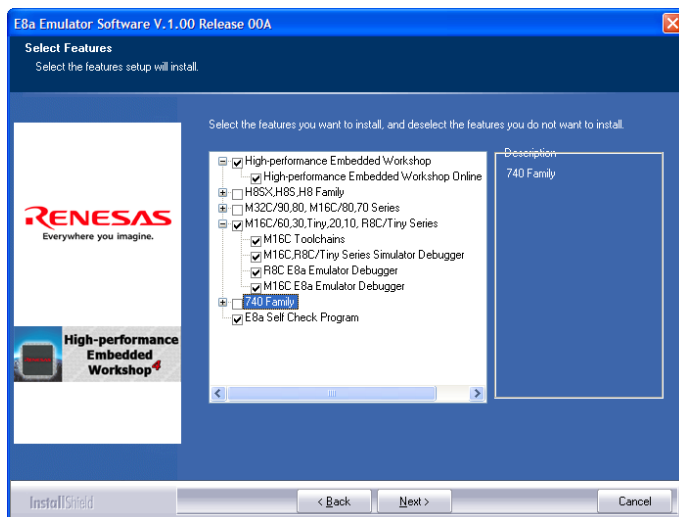

Select the above options then press Next, then Next

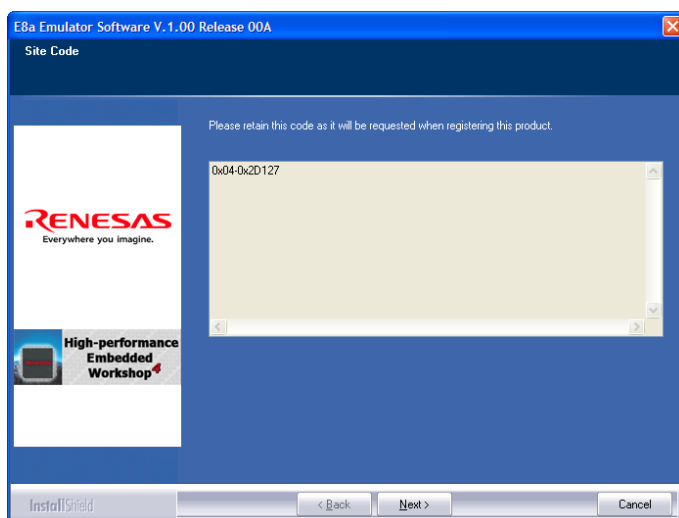

Press Next

STATUS SCIENTIFIC CONTROLS

LC Series Software Configuration and System Calibration

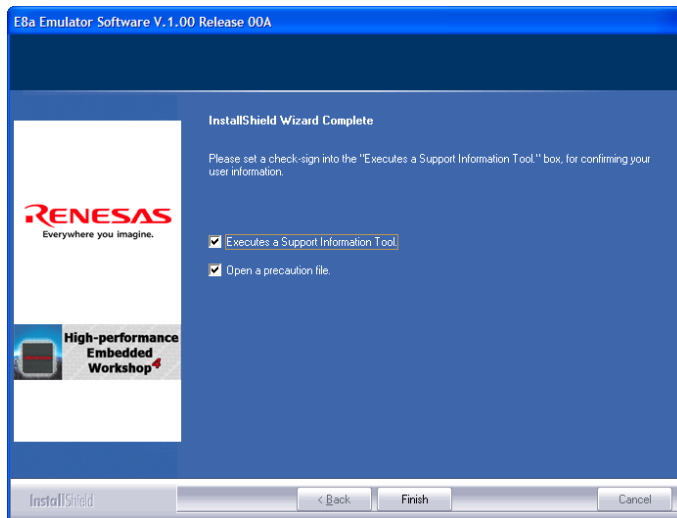

Press Finish.

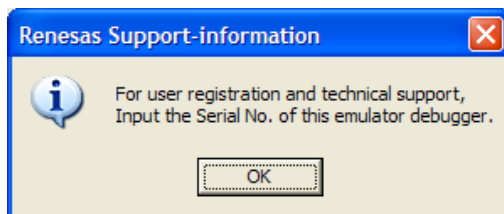

Press OK then fill in the following information.

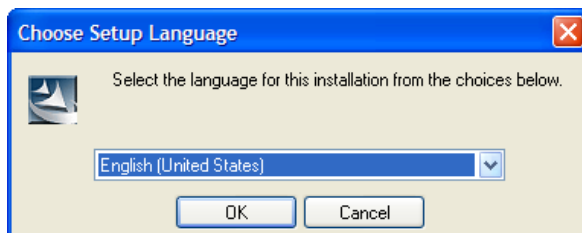

Select language then press OK. Follow the on screen prompts.

8 FIRMWARE UPDATE

From time to time it may be necessary to update the system firmware. This can only be carried out using purpose designed PC software and the Renesas E8a programmer fitted with a specialised lead. See section xx

8.1 Creating a new project.

Launch the PC programmer, default location is typically "C:\Program Files\Renesas\FDT4.01\FDT.exe"

The following screen will be shown:

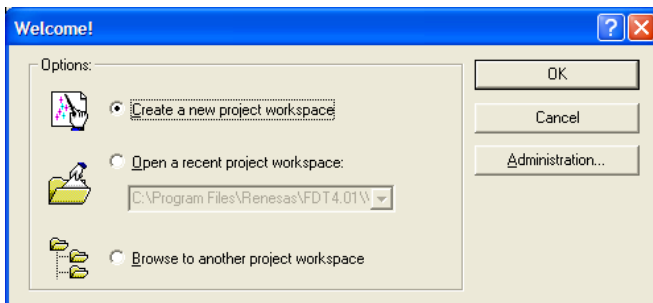

Press OK.

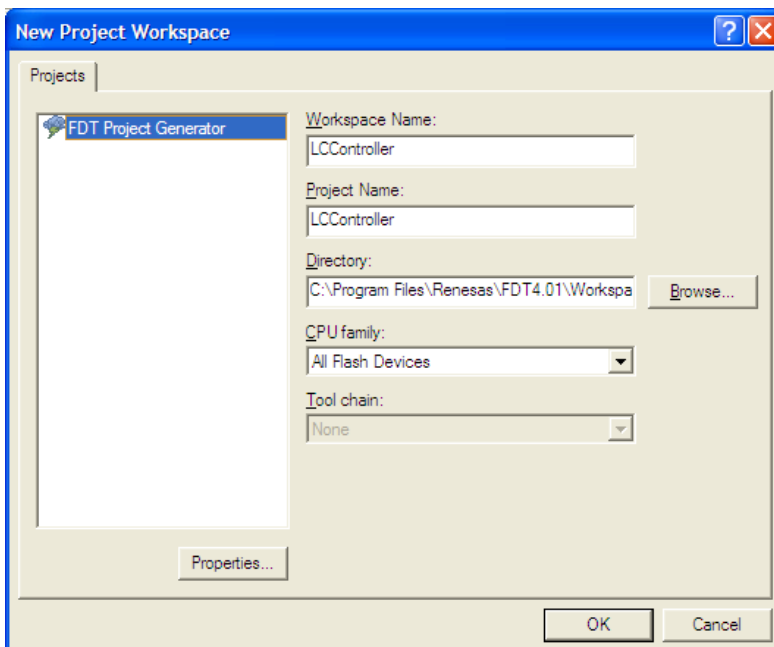

Enter the workspace name, in the above example LC Controller then press OK

STATUS SCIENTIFIC CONTROLS

LC Series Software Configuration and System Calibration

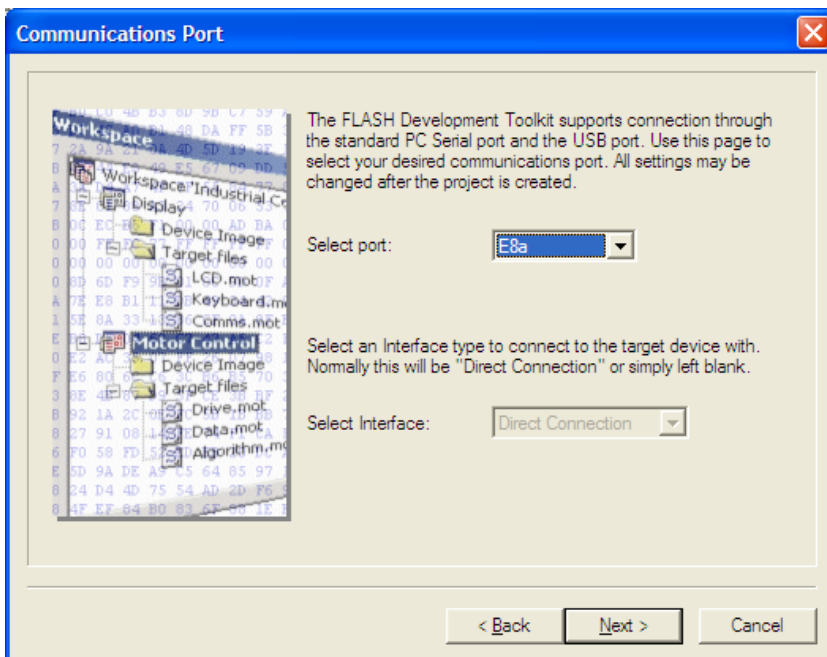
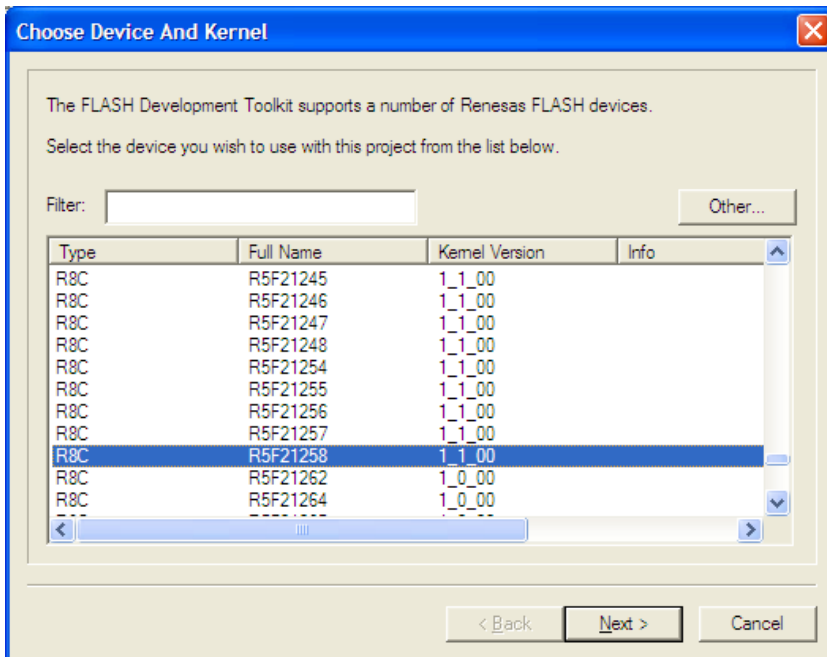

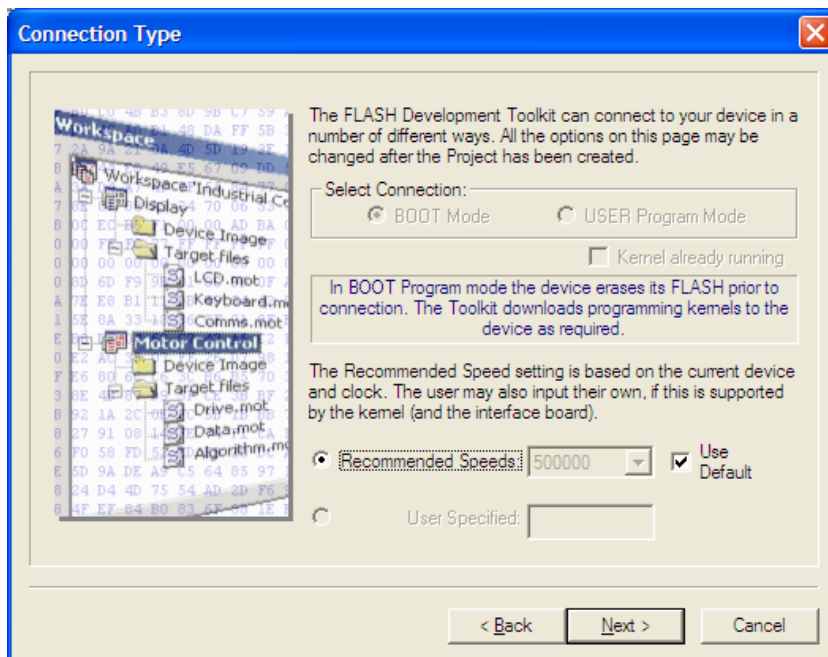

Use the default connection then press next.

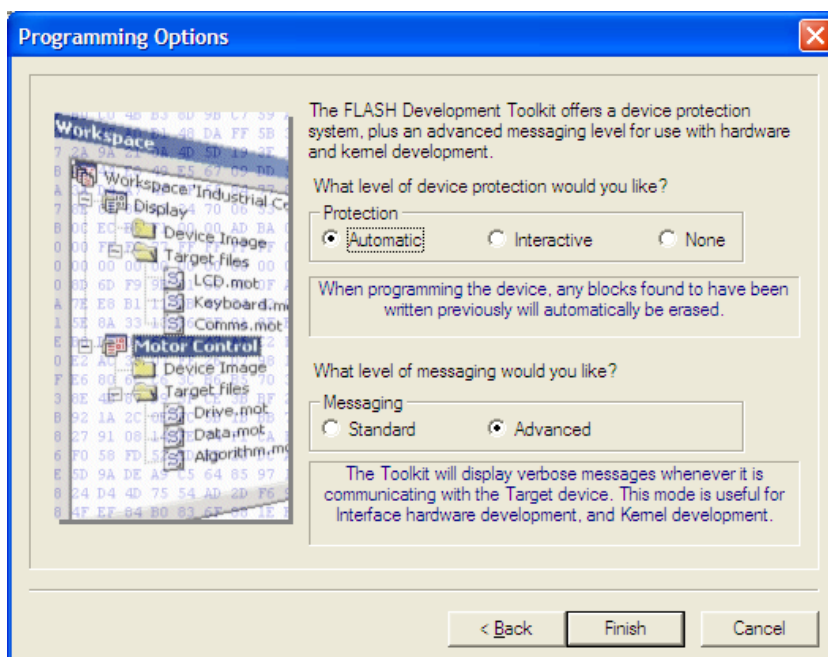

Select Automatic and advanced then press Finish.

STATUS SCIENTIFIC CONTROLS

LC Series Software Configuration and System Calibration



The following screen will be shown:

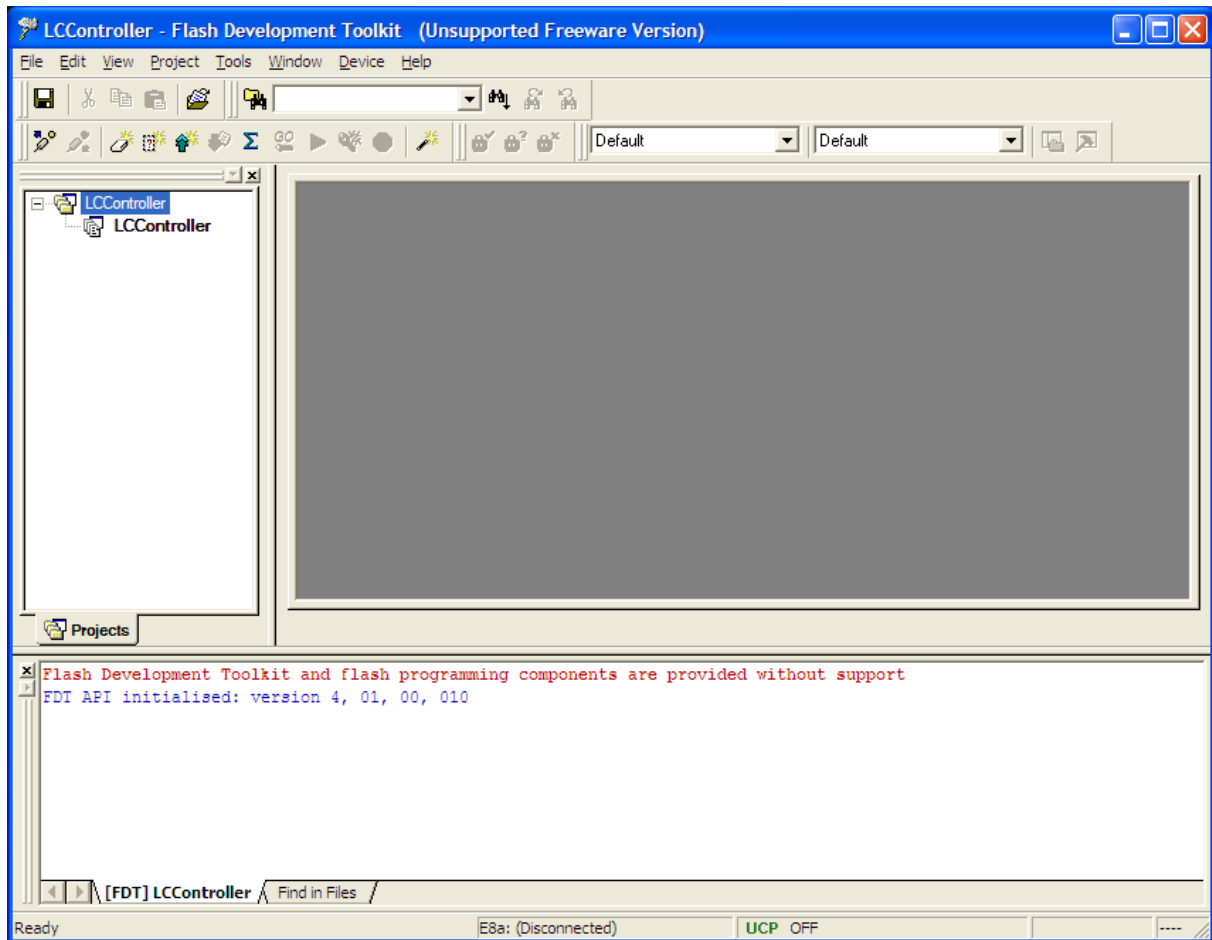

Now add the program file by selecting **Project | Add files**.

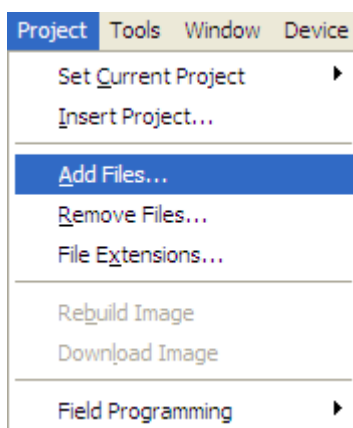

STATUS SCIENTIFIC CONTROLS

LC Series Software Configuration and System Calibration

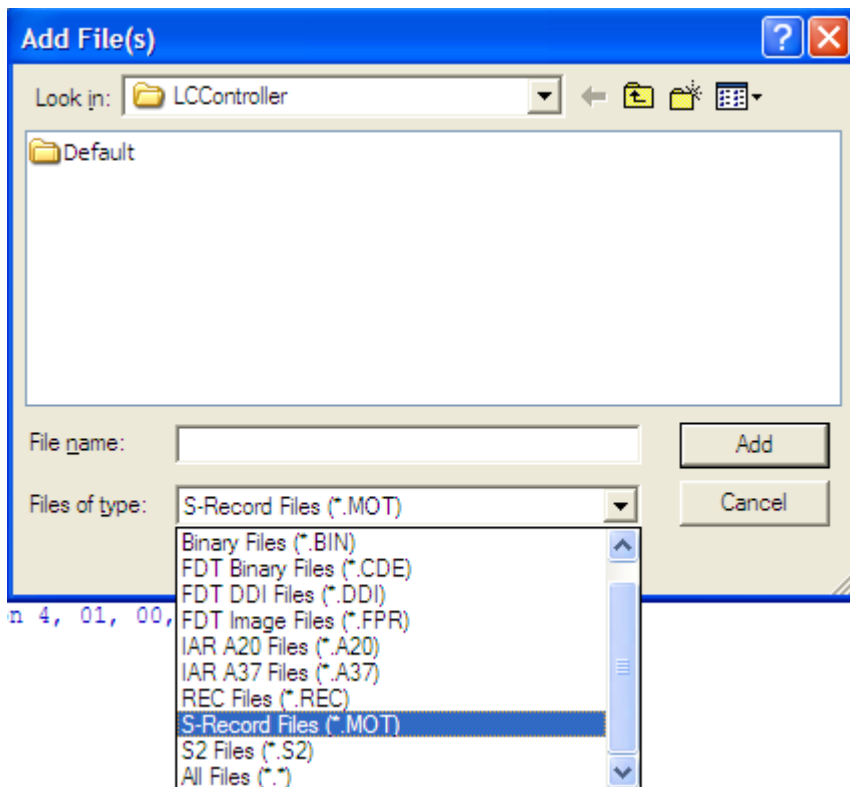

Select the (*.MOT) file as shown above.

Now locate the file location via the 'Look in' entry.

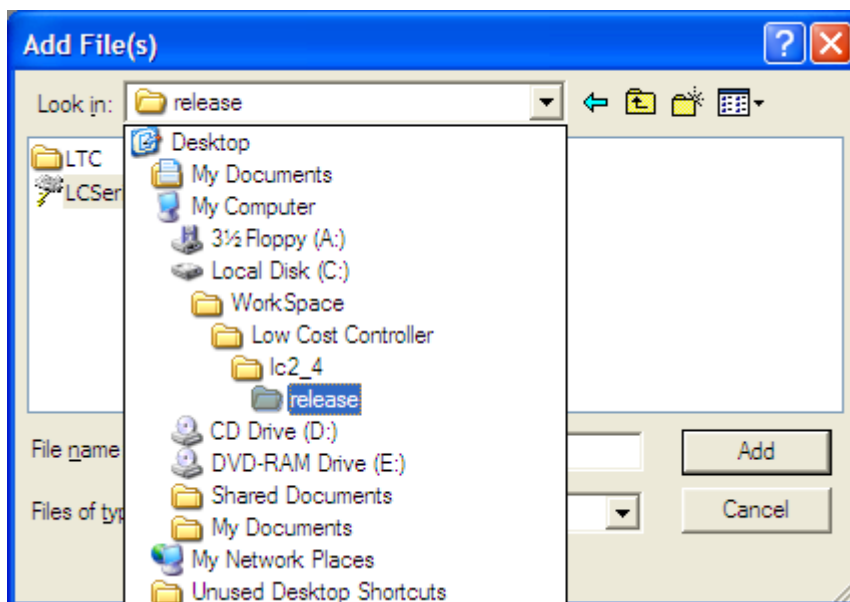

STATUS SCIENTIFIC CONTROLS

LC Series Software Configuration and System Calibration



Select the actual file then select **Add** as shown below.

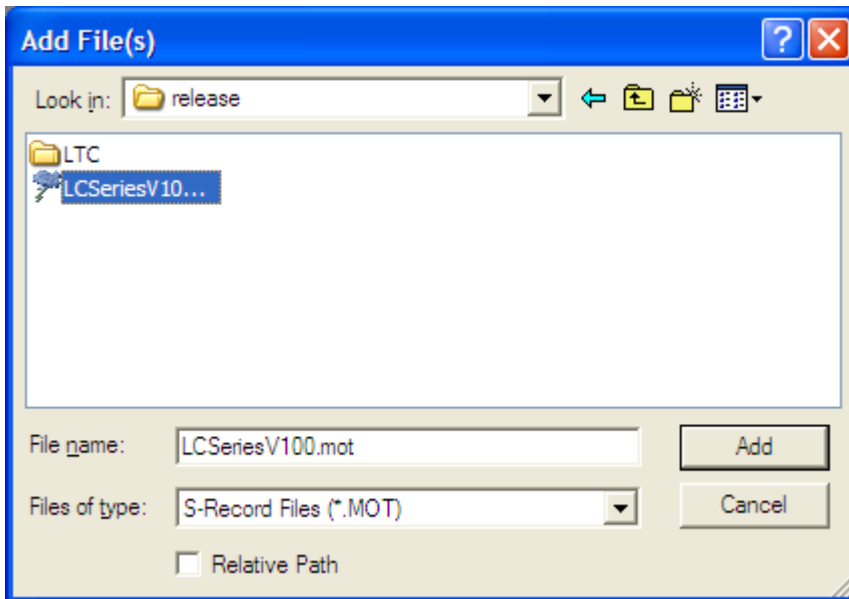

The following screen is shown.

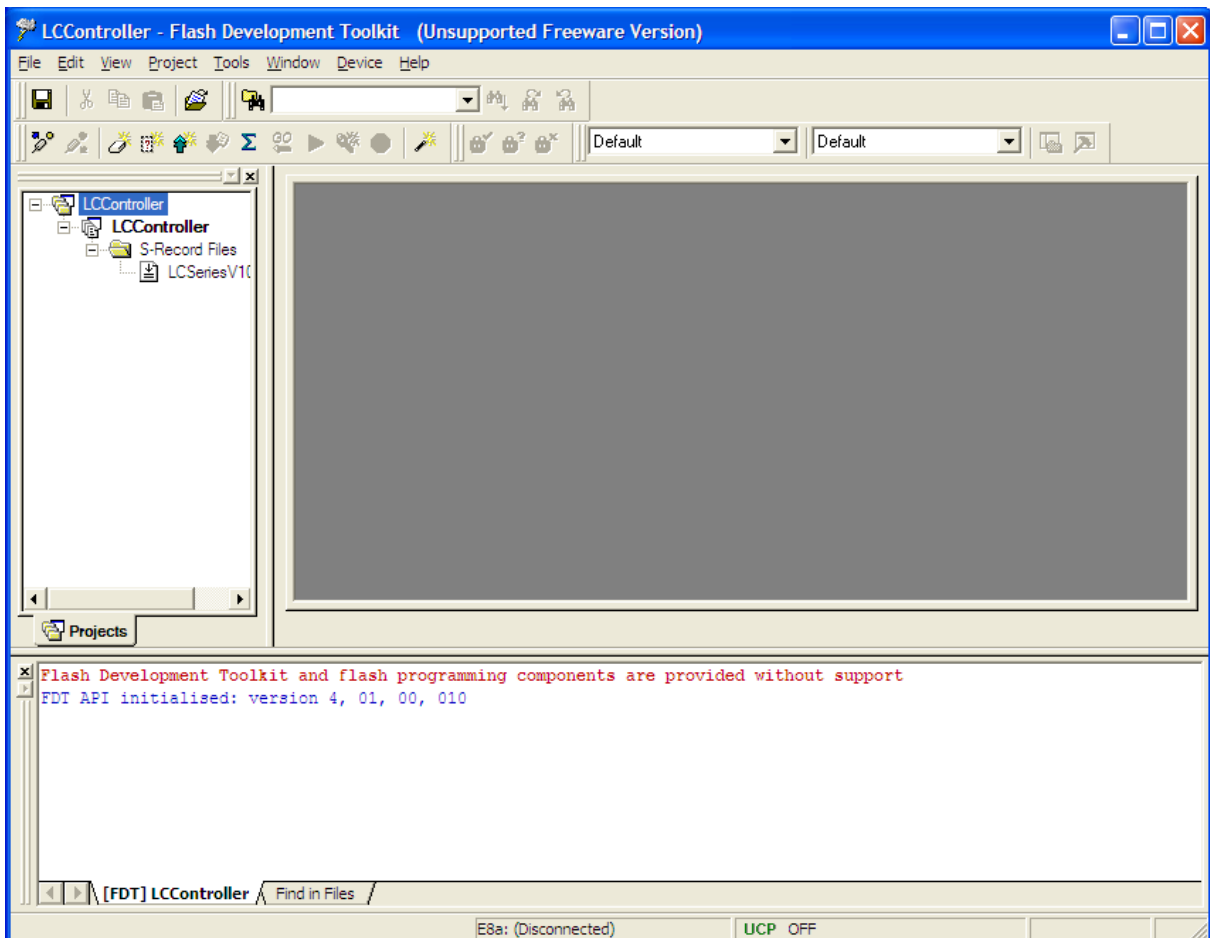

8.2 Programming the LC Controller.

Launch the PC programmer, default location is typically "C:\Program Files\Renesas\FDT4.01\FDT.exe"
Open the project as described in section 8.1.

Connect to the LC Controller by selecting **Device / Connect to device**.

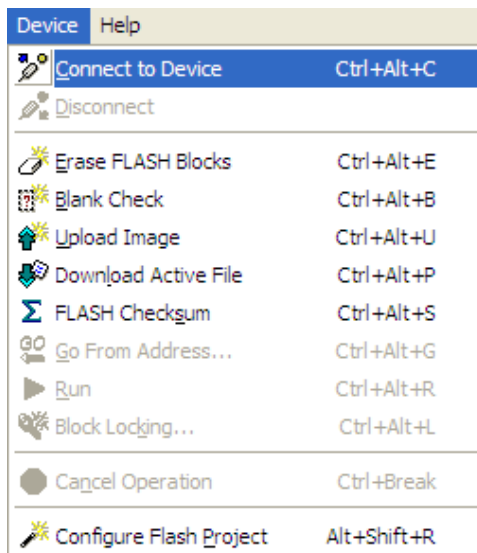

The following screen is show.

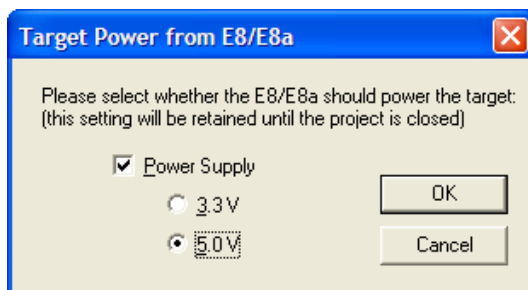

The LC Controller can be powered from the programmer as shown above. Press OK
The following screen is show.

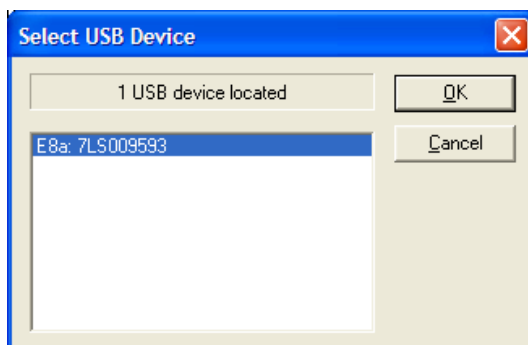

Now press OK

STATUS SCIENTIFIC CONTROLS

LC Series Software Configuration and System Calibration



The lower panel should confirm that the Programmer has successfully opened dialog with the LC Controller as seen below

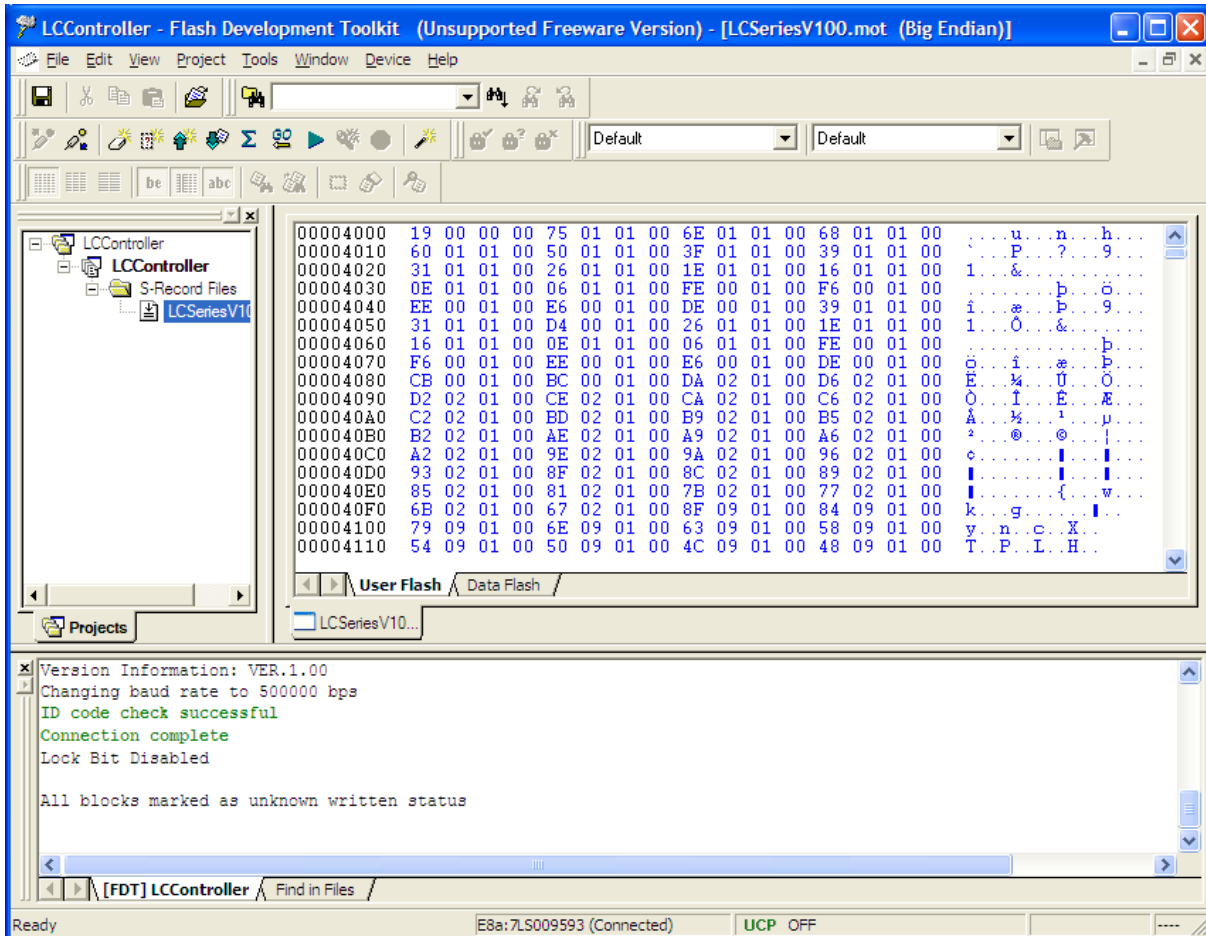

Programming the LC Controller is achieved by selecting **Device / Download Active File**.

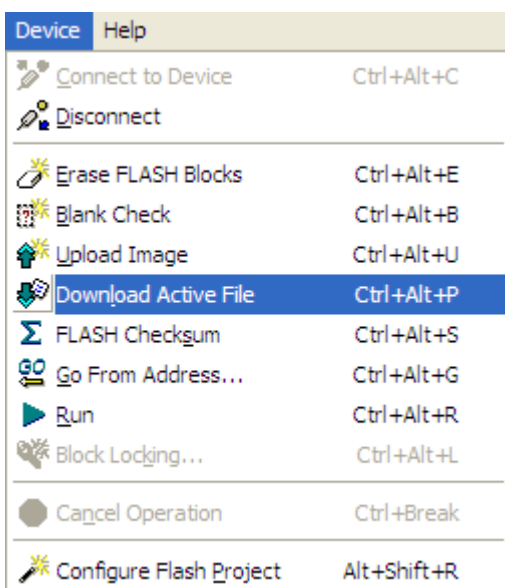

STATUS SCIENTIFIC CONTROLS

LC Series Software Configuration and System Calibration



The programming progress is displayed with the final display shown as below:

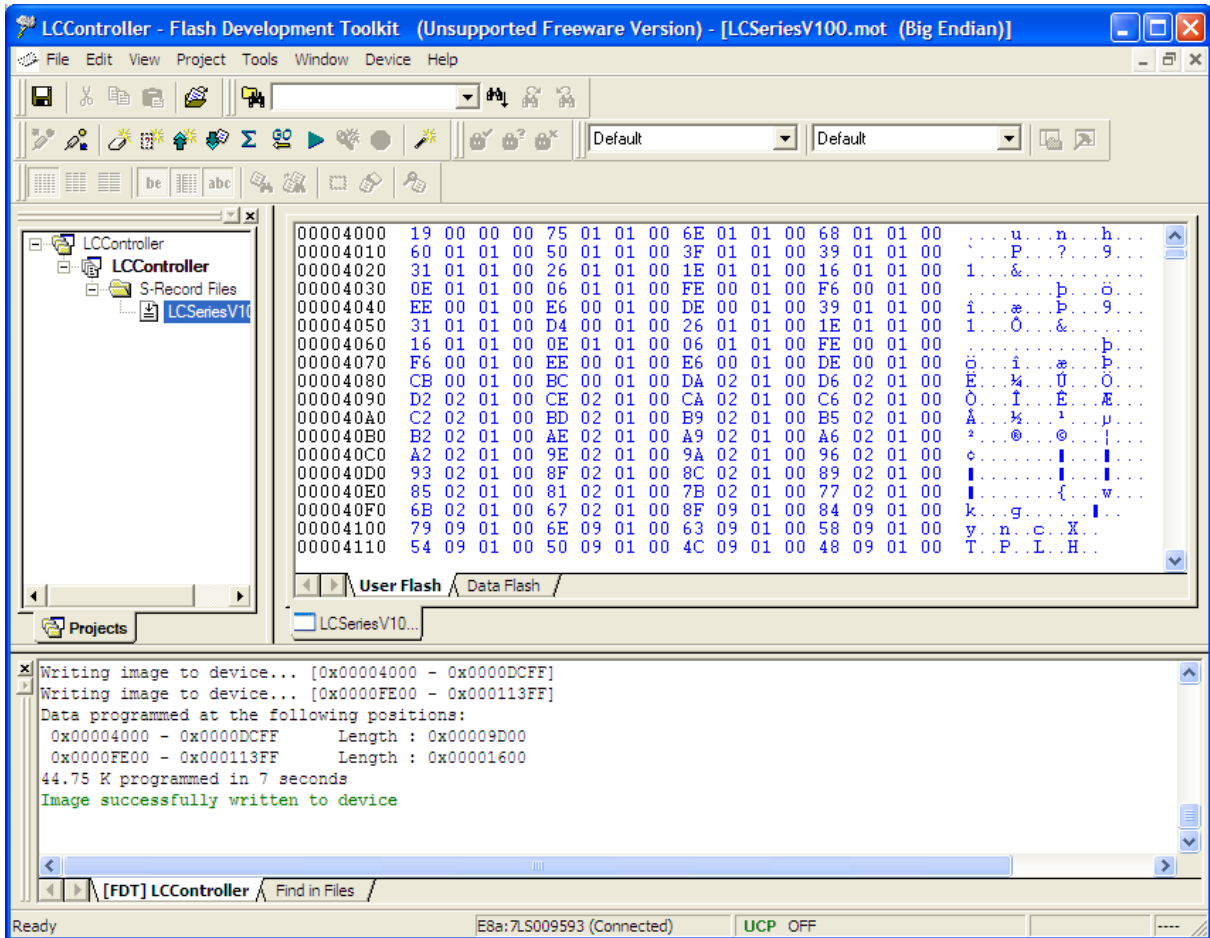

Now disconnect from the LC Controller by selecting **Device / Disconnect**.

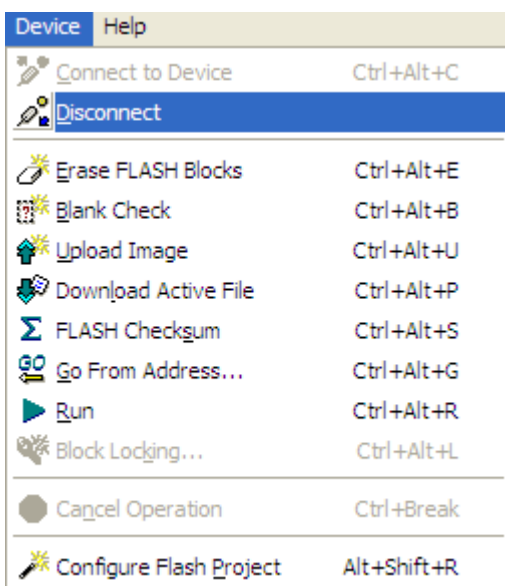

STATUS SCIENTIFIC CONTROLS

LC Series Software Configuration and System Calibration



This page left blank intentionally.