

Opal5/Opal8 Series Entry-Level  
Industrial Ethernet Switch  
Hardware Installation Manual

Publication Date: 2016-06-29

Version: V1.3

No.: 112023031

***KYLAND***

## Certificate of Compliance

### EU Directive 2011/65/EU (RoHS-Directive)

Dear Ladies and Gentlemen,

According to the EU Directive 2011/65/EU the use of several substances for electrical and electronic equipment in defined categories is restricted. Kyland hereby declares that the parts used in our products are produced in full compliance with the Directive 2011/65/EU "Restriction of the Use of Certain Hazardous Substances in Electrical and Electronic Equipment" (RoHS), including all amendments to the EU-directive (e.g. The Restrictions of DecaBDE).

This information and our technical advice – whether verbal, in writing or by way of trials – are given in good faith and to the best of our knowledge but without liability and warranty, unless law admits the liability or warranty. This also applies where proprietary rights of third parties are involved. Our advice does not release you from the obligation to check its validity and to test our products as to their suitability for the intended processes and applications. The application, use and processing of our products and the products manufactured by you on the basis of our technical advice are beyond our control and, therefore, entirely your own responsibility. Our products are sold in accordance with the current version of our General Conditions of Sale and Delivery.

**Disclaimer:** Kyland Technology Co., Ltd. tries to keep the content of this manual as accurate and as updated as possible. This document is not guaranteed to be error-free, and we reserve the right to amend it without notice to users.

#### **All rights reserved.**

No part of this documentation may be excerpted, reproduced, translated, annotated or duplicated, in any form or by any means without the prior written permission of Kyland Corporation.

**Copyright ©2017Kyland Technology Co., Ltd.**

# Notice for Safety Operation

The product performs reliably as long as it is used according to the guidance. Artificial damage or destruction of the device should be avoided. Before using the device, read this notice carefully for personal and equipment safety. Please keep the manual for further reference. If the device used not according to the specified way by Kyland, the protection provided by the device maybe diminished. And Kyland is not liable to any personal or equipment damage caused by violation of this notice.

- Ensure the area where the device is used is clean and dry. Keep the ambient relative humidity within the range from 5% to 95% (non-condensing).Be suitable for indoor use.
- Do not place the device in an environment with high magnetic field, strong shock, or high temperature. Keep the working and storage temperatures within the allowed range.
- Install and place the device securely and firmly.
- Please keep the device clean; if necessary, wipe it with a soft cotton cloth.
- Do not place any irrelevant materials on the device or cables. Ensure adequate heat dissipation and tidy cable layout without being entangled or knotted.
- Wear antistatic gloves or take other protective measures when operating the device.
- Avoid any exposed metal wires because they may be oxidized or electrified.
- Install the device in accordance with related national and local regulations.
- Before power-on, make sure the power supply is within the allowed range of the device. High voltage may damage the device.
- Power connectors and other connectors should be firmly interconnected.
- Do not plug in or out the power supply with wet hands. When the device is powered on, do not touch the device or any parts with wet hands.
- Before operating a device connected to a power cable, remove all jewelry (such as rings, bracelets, watches, and necklaces) or any other metal objects, because they may cause electric shock, burns, or welding.
- Do not operate the device or connect or disconnect cables during an electrical storm.
- Use compatible connectors and cables. If you are not sure, contact our sales or technical support personnel for confirmation.
- Do not disassemble the device by yourself. When an anomaly occurs, contact our sales or technical support personnel.
- If any part is lost, contact our sales or technical support personnel to purchase a replacement. Do not purchase parts from other channels.
- Dispose of the device in accordance with relevant national provisions, preventing environmental pollution.

In the following cases, please immediately shut down your power supply and contact your Kyland representative:

- Water gets into the equipment.
- Equipment damage or shell damage.
- Equipment operation or performance has abnormally changed.
- The equipment emits odor, smoke or abnormal noise.

Note: The security of any system merged with this device is the responsibility of the assembler.

The following information applies when operating this device in hazardous locations:

Suitable for use in Class I, Division 2, Groups A, B, C and D Hazardous Locations, or non-hazardous locations only.

Cet appareillage est utilisable dans les emplacements de Classe I, Division 2, Groupes A, B, C et D, ou dans les emplacements non dangereux seulement.

**WARNING: EXPLOSION HAZARD**

- Do not disconnect equipment while the circuit is live or unless the area is known to be free of ignitable concentrations.
- Substitution of any component may impair suitability for Class I, Division 2.

**AVERTISSEMENT: RISQUE D'EXPLOSION**

- Avant de deconnecter l'equipement, couper le courant ou s'assurer que l'emplacement est designe non dangereux.
- La substitution de composants peut rendre ce materiel inacceptable pour les emplacements de Classe I, Division 2.

# Contents

1 Product Overview	1
2 Structure and Interface	3
2.1 Front Panel	3
2.2 Top Panel	4
3 Mounting	4
3.1 Dimension Drawing	4
3.2 Mounting Modes and Steps	5
3.2.1 DIN-Rail Mounting	5
3.2.2 DIN-Rail Dismounting	6
4 Connection	6
4.1 10/100Base-T(X) Ethernet Port	6
4.2 100Base-FX Ethernet Port	8
4.3 100Base-X SFP Slot	8
4.4 Grounding	10
4.5 Power Terminal Block	10
4.6 DIP Switches	12
5 LEDs	13
6 Basic Features and Specifications	14
7 Certificates Used for Compliance	15
8 Appendix	15

# 1 Product Overview

Opal5/Opal8 entry-level industrial Ethernet switches are specially designed for industrial control applications.

Opal5/Opal8 supports normal-temperature-range and wide-temperature-range models. Broadcast storm protection can be configured through DIP switch.

The series switches support DIN rail mounting. Opal5 provides four 10/100Base-T(X) Ethernet ports, one 100M copper or fiber (optional); Opal8 provides six 10/100Base-T(X) Ethernet ports, two 100M copper or fiber (optional). For details, see the following table.

Table 1 Opal5 Models

Models	Opal5-Ports-Connector-PS1-PS2 Opal5-E-Ports-Connector-PS1-PS2
Code definition	Code option
E	E: Normal temperature range models, ambient temperature: -10°C ≤ Tamb ≤ +60°C N/A: Wide temperature range models, ambient temperature: -40°C ≤ Tamb ≤ +75°C
Ports: S/M, T	5T=five 10/100Base-T(X) ports 1S4T=one 100Base-FX ports, single mode; four 10/100Base-T(X) ports 1M4T=one 100Base-FX ports, multiple mode; four 10/100Base-T(X) ports 1SFP4T=one 100Base-X SFP slots; four 10/100Base-T(X) ports
Connector: parameters	<b>Ports with M:</b> SC05=SC connector, 1310nm, 5km ST05=ST connector, 1310nm, 5km FC05=FC connector, 1310nm, 5km <b>Ports with S:</b> SC40=SC connector, 1310nm, 40km ST40=ST connector, 1310nm, 40km FC40=FC connector, 1310nm, 40km SC60=SC connector, 1310nm, 60km ST60=ST connector, 1310nm, 60km FC60=FC connector, 1310nm, 60km SC80=SC connector, 1550nm, 80km ST80=ST connector, 1310nm, 80km FC80=FC connector, 1310nm, 80km <b>Ports with SFP:</b> SMSFP= Single mode 100Base-X SFP module plugged into SFP slot MMSFP= Multi mode 100Base-X SFP module plugged into SFP slot N/A= No SFP module plugged into SFP slot
PS1-PS2: power input	LV-LV=24VAC/DC (18-30VAC, 50/60Hz; 12-48VDC), redundant power input

Table 2 Opal8 Models

Model	Opal8-Ports-Connector-PS1-PS2 Opal8-E-Ports-Connector-PS1-PS2
Code definition	Code option
E	E: Normal temperature range models, ambient temperature: -10°C ≤ Tamb ≤ +60°C N/A: Wide temperature range models, ambient temperature: -40°C ≤ Tamb ≤ +75°C
Ports: S/M, T	8T= eight 10/100Base-T(X) ports 1S7T= one 100Base-FX port, single mode; seven 10/100Base-T(X) ports 1M7T= one 100Base-FXport, multiple mode; seven 10/100Base-T(X) ports 2S6T=two 100Base-FX ports, single mode; six 10/100Base-T(X) ports 2M6T=two 100Base-FX ports, multiple mode; six 10/100Base-T(X) ports 1SF6T= one 100Base-XSFPslot; seven 10/100Base-T(X) ports 2SF6T=two 100Base-X SFP slots; six 10/100Base-T(X) ports
Connector: parameters	<b>Ports with M:</b> SC05=SC connector, 1310nm, 5km ST05=ST connector, 1310nm, 5km FC05=FC connector, 1310nm, 5km <b>Ports with S:</b> SC40=SC connector, 1310nm, 40km ST40=ST connector, 1310nm, 40km FC40=FC connector, 1310nm, 40km SC60=SC connector, 1310nm, 60km ST60=ST connector, 1310nm, 60km FC60=FC connector, 1310nm, 60km SC80=SC connector, 1550nm, 80km ST80=ST connector, 1310nm, 80km FC80=FC connector, 1310nm, 80km <b>Ports with SFP:</b> SMSFP= Single mode 100Base-X SFP module plugged into SFP slot MMSFP= Multi mode 100Base-X SFP module plugged into SFP slot N/A= No SFP module plugged into SFP slot
PS1-PS2: power input	LV-LV=24VAC/DC (18-30VAC, 50/60Hz; 12-48VDC), redundant power input

**Note:**

- We reserve the right to amend the product information listed in this table without notice. To obtain the latest information, you can contact our sales or technical support personnel.

## 2 Structure and Interface



### Caution:

It is recommended to purchase the port dustproof shield (optional) to keep ports clean and ensure switch performance.

### 2.1 Front Panel

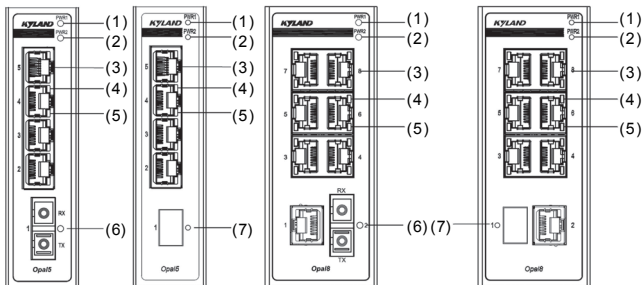

Figure 1 Front Panel

- (1) Power 1 LED
- (2) Power 2 LED
- (3) 10/100Base-T(X) Ethernet port
- (4) 10/100Base-T(X) Ethernet port connection status LED (green)
- (5) 10/100Base-T(X) Ethernet port speed LED (yellow)
- (6) 100Base-FX Ethernet port and its connection status LED
- (7) 100Base-X SFP slot and its connection status LED



## 2.2 Top Panel

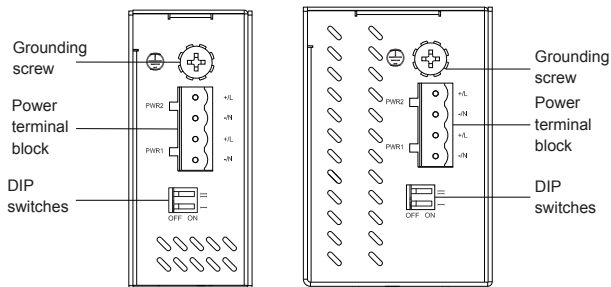

Figure 2 Top Panel

## 3 Mounting

### 3.1 Dimension Drawing

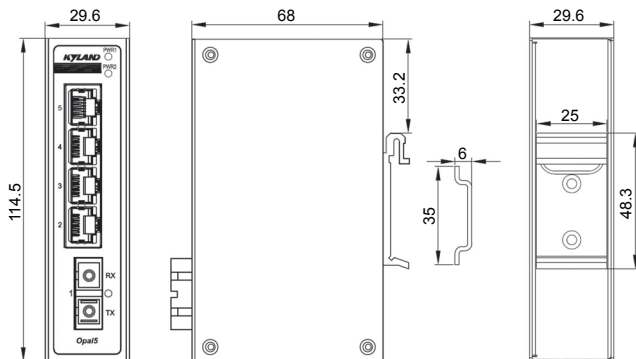

Figure 3 Opal5 Dimensions for DIN-Rail Mounting (unit: mm)

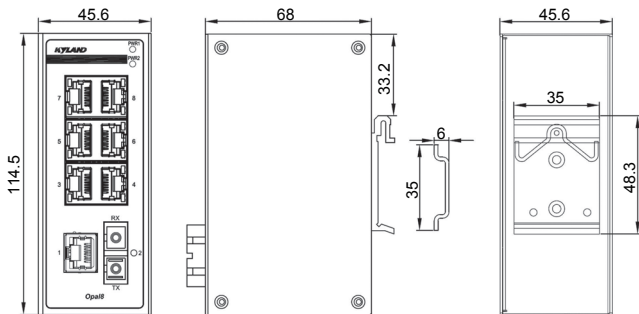

Figure 4 Opal8 Dimensions for DIN-Rail Mounting (unit: mm)



#### Caution:

- As part of the heat dissipation system, the switch housing becomes hot during operation. Please use caution when coming in contact and avoid covering the switch housing when the switch is running.
- The figures in this manual are only for reference.

## 3.2 Mounting Modes and Steps

The device supports DIN-rail mounting. Before installation, make sure that the following requirements are met.



#### Note:

- Devices are to be installed in an ATEX /IECEX Certified IP54 enclosure and accessible only by the use of a tool.
- Devices are for use in an area of not more than pollution degree 2 in accordance with IEC 60664-1.
- Customers shall insure device working in the right ambient temperature,  $-10^{\circ}\text{C} \leq T_{\text{amb}} \leq +60^{\circ}\text{C}$  for Opal5-E & Opal8-E series and  $-40^{\circ}\text{C} \leq T_{\text{amb}} \leq +75^{\circ}\text{C}$  for Opal5 & Opal8 series.
- No direct sunlight, distant from heat source and areas with strong electromagnetic interference.

### 3.2.1 DIN-Rail Mounting

Step 1: Select the mounting position for the device and guarantee adequate space and heat dissipation.

Step 2: Insert the connecting seat onto the top of the DIN rail, and push the bottom of the device inward and upward to ensure the DIN rail fits in the connecting seat. Make sure the device is firmly installed on the DIN rail, as shown in the following figure.

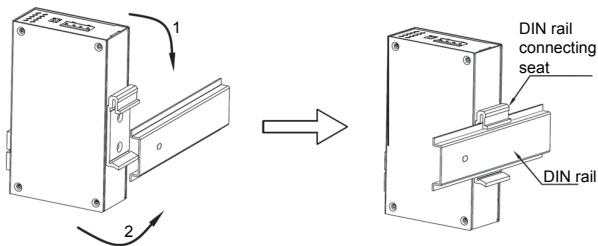

Figure 5 DIN-Rail Mounting

### 3.2.2 DIN-Rail Dismounting

Step 1: As shown in the following figure, press the device downward and move the device in direction 1 until the bottom of the device is detached from the DIN rail.

Step 2: Pull the device upward and move the device in direction 2 until the device is removed from the DIN rail completely.

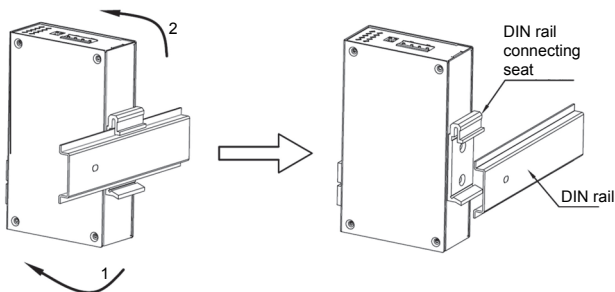

Figure 6 DIN Rail Dismounting

## 4 Connection

### 4.1 10/100Base-T(X) Ethernet Port

10/100Base-T(X) Ethernet port is equipped with RJ45 connector. The port is self-adaptive. It can automatically configure itself to work in 10M or 100M state, full or half duplex mode. The port can also adapt to MDI or MDI-X connection automatically. You can connect the port to a terminal or network device with a straight-through or cross-over cable.

- Pin Definition

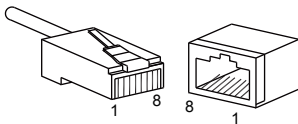



Figure 7 RJ45 Port

Table 3 Pin Definitions of 10/100Base-T(X) RJ45 Port

Pin	MDI-X Signal	MDI Signal
1	Receive Data+ (RD+)	Transmit Data+ (TD+)
2	Receive Data- (RD-)	Transmit Data- (TD-)
3	Transmit Data+ (TD+)	Receive Data+ (RD+)
6	Transmit Data- (TD-)	Receive Data- (RD-)
4, 5, 7, 8	Unused	Unused

 **Note:**  
 "+" and "-" indicate level polarities.

- Wiring Sequence

Straight-through Cable

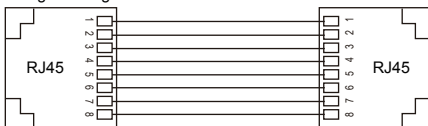

Crossover Cable

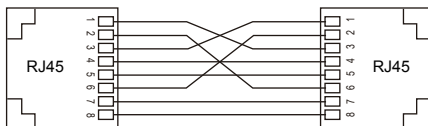

Figure 8 Connection Using Straight-through/Cross-over Cable



**Note:**

The color of the cable for RJ45 connector meets the 568B standard: 1- orange and white, 2-orange, 3-green and white, 4-blue, 5-blue and white, 6-green, 7-brown and white, and 8-brown.

## 4.2 100Base-FX Ethernet Port

100Base-FX Ethernet port is equipped with ST/SC connector, and each port consists of TX (transmit) port and RX (receive) port. To enable data transmission between Device A and Device B, connect the TX port of Device A to the RX port of Device B, and the RX port of Device A to the TX port of Device B. The following figure shows the wiring sequence of the 100Base-FX Ethernet port. (The following uses an SC port as an example. The wiring sequence of an ST port is the same with that of the SC port.)

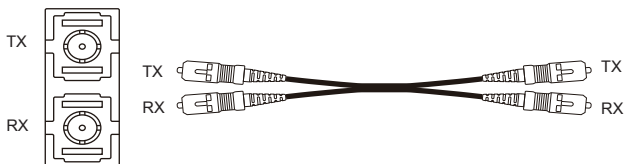

Figure 9 Connection of 100Base-FX Ethernet Port



### Caution:

The device uses laser to transmit signals in fibers. The radiation has not been evaluated. The laser meets the requirements of level 1 laser products. Routine operation is not harmful to your eyes, but do not look directly at the fiber port when the device is powered on.

## 4.3 100Base-X SFP Slot

100Base-X SFP slot: You can enable data transmission only after inserting an SFP optical module into the slot and connecting cable properly. The switch, which name contains “SMSFP” or “MMSFP”, is equipped with the SFP optical modules in the following table.

Table 4 SFP Optical Modules for 100Base-X SFP slot

Model	Interface	MM/SM	Connector	Transmission Distance	Manufacturer
HSFP-03-3312M-22F	100Base-FX port	MM	LC	2km	HI-OPTTEL
HSFP-03-3312S-22F	100Base-FX port	SM	LC	20km	HI-OPTTEL
OP3220D	100Base-X port	SM	LC	20km	OPWAY
OP3202D	100Base-X port	MM	LC	2km	OPWAY

The center Wavelength (CWL) of SFP module above is 1310nm.

- 100Base-XSFP Optical Module

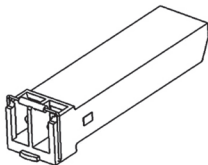

Figure 10 100Base-XSFP Optical Module

SFP optical module is equipped with LC connector, and each port consists of a TX (transmit) port and an RX (receive) port. To enable communication between Device A and Device B, connect the TX (transmit) port of Device A to the RX (receive) port of Device B, and the RX (receive) port of Device A to the TX (transmit) port of Device B. The following figure shows the cable connection of the SFP optical module.



Figure 11 Cable Connection of SFP Optical Module

- How to Connect the SFP Optical Module

Insert the SFP optical module into the SFP slot in the switch, and then plug the optical fiber into the TX port and RX port of the SFP module.

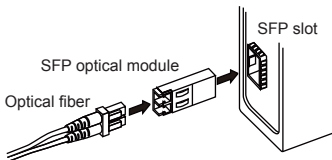

Figure 12 Connecting the SFP Optical Module

## How to Determine the RX Port and TX Port of SFP Optical Module

1. Insert the two connectors in one end of optical fiber into the SFP module, and those in the other end of the optical fiber into the SFP module of another switch.
2. View the corresponding port connection status LED in the front panel: If the LED blinks, the link is connected. If the LED is off, the link is not connected. This may be caused by incorrect connection of the TX and RX ports. In this case, swap the two connectors in the one end of the optical fiber.



### Caution:

- The device uses laser to transmit signals in fibers. The laser meets the requirements of level 1 laser products. Routine operation is not harmful to your eyes, but do not look directly at the fiber port when the device is powered on.
- If the defined transmission distance of an SFP module is longer than 60km, do not use a short fiber (<20km) for connection. If such a short fiber is used, the module will be burned.

## 4.4 Grounding

Grounding protects the device from lightning and interference. Therefore, you must ground the device properly. You need to ground the device before it is powered on and disconnect the grounding cable after the device is powered off. There is a grounding screw (see Figure 2) on the top panel of the switch. The screw is for chassis grounding. After crimping one end of the grounding cable to a cold pressed terminal, secure the end of the grounding cable to the grounding screw and firmly connect the other end to ground.



### Note:

Cross-sectional area of the chassis grounding cable  $>2.5\text{mm}^2$ ; Grounding resistance  $<5\Omega$ .

## 4.5 Power Terminal Block

There is a power terminal block on the top panel of the device. You need to connect the power wires to the terminal block to provide power for the device. The switch supports redundant power supply with 4-pin 5.08mm-spacing plug-in terminal block. When one power input is faulty, the switch can continue operating properly, thereby improving network reliability.

**Note:**

- Others:  Suitable cable with temperature of 85.5°C at least must be used for the power input terminal.
- All field wiring intended for connection to the power terminal shall consist of copper conductors with the insulation locally removed. Additional intermediate connecting parts, other than ferrules, shall not be used.

**● 4-Pin 5.08mm-Spacing Plug-in Terminal Block**

Figure 13 4-Pin 5.08mm-Spacing Plug-in Terminal Block (socket)

Table 5 Pin Definitions of 4-Pin 5.08mm-Spacing Plug-in Terminal Block

Pin Number	DC Wiring Definition	AC Wiring Definition
1	PWR1: -	PWR1: N
2	PWR1: +	PWR1: L
3	PWR2: -	PWR2: N
4	PWR2: +	PWR2: L

**● Wiring and Mounting**

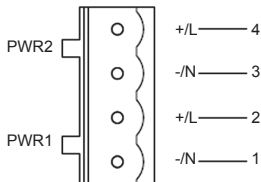
Step 1: Ground the device properly according to section 4.4.

Step 2: Remove the power terminal block from the device.

Step 3: Insert the power wires into the power terminal block according to Table 5 and secure the wires.

Step 4: Insert the terminal block with the connected wires into the terminal block socket on the device.

Step 5: Connect one end of the power cable to an external power supply system (with the allowed power range). If the power LED on the front panel of the switch turns on, the power supply is connected properly.

Wiring and mounting should meet following specifications.

Table 6 Wiring and Mounting Specifications

Terminal Type	Required Torque	Wire Range (AWG)
Terminal Block Plug	4.5-5.0 lb-in	12-24



**Caution:**

- Provision shall be made to prevent the rated voltage from being exceeded by transient disturbances of more than 140% of the rated voltage.
- Power adapter provide by end customers shall be non-sparking.
- Before connecting the device to power supply, make sure that the power input meets the power requirement. If connected to an incorrect power input, the device may be damaged.
- To comply with UL restrictions, this equipment must be powered from a source compliant with SELV.

**Warning:**

- Do not touch any exposed conducting wire, terminal, or component with a voltage warning sign, because it may cause personal injury.
- Do not remove any part or plug in or out any connector when the device is powered on.

## 4.6 DIP Switches

There are two DIP switches on the top panel of the device, each switch has ON and OFF states, and the default state is OFF. The function of the DIP switches is shown in the following table.

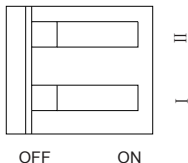

Figure 14 DIP Switches

Table 7 Description of the DIP Switches

DIP Switches	State	Description
I	ON	Enable broadcast storm protection
	OFF	Disable broadcast storm protection
II		Reserved

## 5 LEDs

Table 8 LEDs

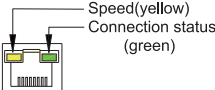
LED	State	Description
Power 1 LED	On	The power 1 is connected and operates properly.
	Off	The power 1 is not connected or operates abnormally.
Power 2 LED	On	The power 2 is connected and operates properly.
	Off	The power 2 is not connected or operates abnormally.
100Base-FX Ethernet port / 100Base-X SFP slotconnection statusLED	On	Effective port connection
	Blinking	Ongoing network activities
	Off	No effective port connection
 <p>Speed(yellow) Connection status (green)</p>		
10/100Base-T(X) Ethernet port speed LED (yellow)	On	100M working state (100Base-TX)
	Off	10M working state or no connection
10/100Base-T(X) Ethernet port connection status LED (green)	On	Effective port connection
	Blinking	Ongoing network activities
	Off	No effective port connection

## 6 Basic Features and Specifications

<b>Power Supply</b>		
Power Identifier	Range	
LV	24VAC/DC(18-30VAC, 50/60Hz; 12-48VDC)	
Terminal Block	4-Pin 5.08mm-Spacing Plug-in Terminal Block	
<b>Rated Power Consumption</b>		
Rated Power Consumption	Opal5: 3.4W (MAX) Opal8: 4.6W (MAX)	
<b>Physical Characteristics</b>		
Housing	Metal, fanless	
Protection Class	IP30	
Installation	DIN-Rail Mounting	
Dimensions(W×H×D)	Opal5: 29.6mm×114.5mm×68mm Opal8: 45.6mm×114.5mm×68mm (excluding connectors, DIN rail)	
Weight	Opal5: 0.2Kg Opal8: 0.3Kg	
<b>Environmental Limits</b>		
Applicable Environmental	Indoor	
Ambient Temperature	-10℃ ≤ Tamb ≤60℃	Opal5-E series, Opal8-E series
	-40℃ ≤ Tamb ≤75℃	Opal5 series, Opal8 series
Storage Temperature	-40℃ ~ +85℃	
Ambient Relative Humidity	5% ~ 95% (no condensing)	
Pollution degree	2	
Altitude	2000m	
<b>MTBF</b>		
MTBF	Opal5: 4500764h Opal8: 4044813h	
<b>Warranty</b>		
Warranty	Five years	

## 7 Certificates Used for Compliance

Certificates Approvals	
EMC	CE, FCC 47CFR Part2 and part15 Class A
Safety	UL508/UL61010, Class1 Div2, ATEX/IECEX

## 8 Appendix



1. UL control number:4SH7,3MSY.
2. The product identity: IND. CONT. EQ. FOR HAZ. LOC. Class I, Division 2, Groups A, B, C and D Hazardous Locations.
3. Max Ambient temperature:75°C for Opal5/8 series and 60°C for Opal5/8-E series.



Opal5-E-1SFP4T, Opal8-E-1SFP7T, Opal8-E-2SFP6T, Opal5-1SFP4T,  
Opal8-1SFP7T, Opal8-2SFP6T:

1. ATEX Certificate No: DEMKO 17 ATEX 1822X.
2. IECEx Certificate No: IECEx UL 17.0002X.
3. Protective method: Ex nA IIC T4 Gc.
4. Ambient rating:  $-40^{\circ}\text{C} \leq T_{\text{amb}} \leq 75^{\circ}\text{C}$  for Opal5/8 series and  $-10^{\circ}\text{C} \leq T_{\text{amb}} \leq 60^{\circ}\text{C}$  for Opal5/8-E series.
5. Standard covered: EN 60079-0:2012+A11:2013/IEC60079-0:Ed.6,  
EN 60079-15:2010/IEC60079-15:Ed.4.

#### 6. Condition of safe use:

- The equipment shall only be used in an area of not more than pollution degree 2, as defined in EN/IEC 60664-1.
- The equipment shall be installed in an enclosure that provides a degree of protection not less than IP 54 in accordance with EN/IEC 60079-15 and enclosure only accessible with tool removable cover.
- Transient protection shall be provided that is set at a level not exceeding 140 % of the peak rated voltage value at the supply terminals to the equipment.

#### Others:

1. ATEX Certificate No: DEMKO 17 ATEX 1822X.
2. IECEx Certificate No: IECEx UL 17.0002X.
3. Protective method: Ex nA IIC T4 Gc.
4. Ambient rating:  $-40^{\circ}\text{C} \leq T_{\text{amb}} \leq 75^{\circ}\text{C}$  for Opal5/8 series and  $-10^{\circ}\text{C} \leq T_{\text{amb}} \leq 60^{\circ}\text{C}$  for Opal5/8-E series.
5. Standard covered: EN 60079-0:2012/IEC60079-0:Ed.6,  
EN 60079-15:2010/IEC60079-15:Ed.4.

#### 6. Condition of safe use:

- Subject devices are to be installed in an IECEx/ATEX Certified IP54 (as defined in IEC60529) enclosure and accessible only by the use of a tool.
- Subject devices are for use in an area of not more than pollution degree 2 in accordance with IEC 60664-1.
- Provision shall be made to prevent the rated voltage from being exceeded by transient disturbances of more than 140% of the rated voltage.
-  Suitable cable with temperature of  $85.5^{\circ}\text{C}$  at least must be used for the power input terminal.

## ***KYLAND***

Kyland Technology Co., Ltd.

FAX: +86-10-88796678

Website: <http://www.kyland.com>

Email: [support@kyland.com](mailto:support@kyland.com)

Factory Address:

NO.901, FLOOR8-12, BUILDING  
NO.2, SHIXING AVENUE30#,  
SHIJINGSHAN DIST, BEIJING  
100144 CHINA