

Aquam5/Aquam8 Series Industrial Ethernet Switches

Hardware Installation Manual

Publication Date: Jan. 2016

Version: V1.1

No.: 112023037

KYLAND

Aquam5/Aquam8 Series Industrial Ethernet Switches Hardware Installation Manual

Disclaimer: Kyland Technology Co., Ltd. tries to keep the content of this manual as accurate and as updated as possible. This document is not guaranteed to be error-free, and we reserve the right to amend it without notice to users.

All rights reserved. No part of this documentation may be excerpted, reproduced, translated, annotated or duplicated, in any form or by any means without the prior written permission of KYLAND Corporation.

Copyright © 2016 Kyland Technology Co., Ltd.

Notice for Safety Operation

The product performs reliably as long as it is used according to the guidance. Artificial damage or destruction of the device should be avoided. Before using the device, read this manual carefully for personal and equipment safety. Please keep the manual for further reference. Kyland is not liable to any personal or equipment damage caused by violation of this notice.

- Do not place the device near water sources or damp areas. Keep the ambient relative humidity within the range from 5% to 95% (non-condensing). Be suitable for indoor use only.
- Do not place the device in an environment with high magnetic field, strong shock, or high temperature. Keep the working and storage temperatures within the allowed range.
- Install and place the device securely and firmly.
- Please keep the device clean; if necessary, wipe it with a soft cotton cloth.
- Do not place any irrelevant materials on the device or cables. Ensure adequate heat dissipation and tidy cable layout without knots.
- Wear antistatic gloves or take other protective measures when operating the device.
- Avoid any exposed metal wires because they may be oxidized or electrified.
- Wiring, terminal block and cable should be suitable for use in an ambient temperature of higher than 78°C, please do high temperature protective measures.
- Install the device in accordance with related national and local regulations.
- Before power-on, make sure the power supply is within the allowed range of the device. High voltage may damage the device.
- Power connectors and other connectors should be firmly interconnected.
- Do not plug in or out the power supply with wet hands. When the device is powered on, do not touch the device or any parts with wet hands.
- Before operating a device connected to a power cable, remove all jewelry (such as rings, bracelets, watches, and necklaces) or any other metal objects, because they may cause electric shock or burns.
- Do not operate the device or connect or disconnect cables during an electrical storm.
- Use compatible connectors and cables. If you are not sure, contact our sales or technical support personnel for confirmation.
- Do not disassemble the device by yourself. When an anomaly occurs, contact our sales or technical support personnel.

- If any part is lost, contact our sales or technical support personnel to purchase the substitute. Do not purchase parts from other channels.
- Dispose of the device in accordance with relevant national provisions, preventing environmental pollution.

In the following cases, please immediately shut down your power supply and contact your Kyland representative:

- Water gets into the equipment.
- Equipment damage or shell damage.
- Equipment operation or performance has abnormally changed.
- The equipment emits odor, smoke or abnormal noise.

Contents

1 Product Overview.....	1
2 Structure and Interface.....	2
3 Mounting.....	3
3.1 Dimension Drawing.....	3
3.2 Mounting Modes and Steps.....	3
4 Connection.....	5
4.1 10/100Base-T(X) Ethernet Port.....	5
4.2 Grounding.....	7
4.3 Power port.....	7
5 LEDs.....	9
6 Basic Features and Specifications.....	9

1 Product Overview

Aquam5/Aquam8 includes a series of high-performance industrial Ethernet switches developed by Kyland. The series devices are applicable to the industrial field of various harsh environment with strict requirements on reliability due to the solid closed housing, fanless but heat dissipation-capable single-rib shaped chassis, overcurrent, overvoltage for power input, sound EMC protection of M12 ports, and IP67 protection class. All the devices meet the requirements stipulated in the EN50155, EN50121, EN55022 Class A&B and FCC CFR47 Part 15 industrial standards.

The switches support panel mounting. They provide up to eight 10/100Base-T (X) Ethernet ports.

Table 1 Models

Model	Aquam5-5T-LV-LV, Aquam8-8T-LV-LV Aquam5-H-5T-LV-LV, Aquam8-H-8T-LV-LV	
Remarks	Protection rating	H: IP67 N/A: IP65 Note: IP protection rating is beyond the scope of UL certification.
	Ports	8T: eight 10/100Base-T(X) M12 ports
	Power input	LV-LV(24VAC/DC(18-30VAC, 50/60Hz; 12-48VDC), 20% tolerance of the voltage range, redundant power input)



Note:

We reserve the right to amend the product information listed in this table without notice. To obtain the latest information, you can contact our sales or technical support personnel.

2 Structure and Interface



Caution:

- It is recommended to purchase the port dustproof shield (optional) to keep ports clean and ensure switch performance.
- If the equipment is used in a manner not specified by the manufacturer, the protection provided by the equipment may be impaired.

● Front Panel

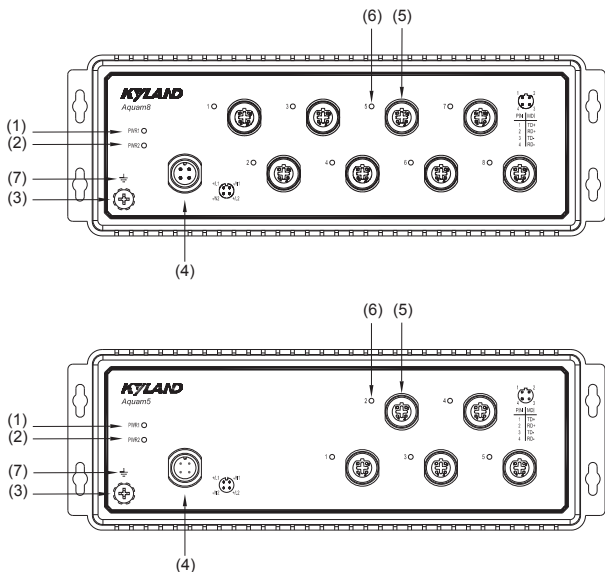

Figure 1 Front Panel

- | | | |
|---|-----------------------------------|---------------------|
| (1) Power 1 LED | (2) Power 2 LED | (3) Grounding screw |
| (4) Power port | (5) 10/100Base-T(X) Ethernet Port | |
| (6) 10/100Base-T(X) Ethernet Port connection status LED | | |
| (7) The grounding identifier | | |

3 Mounting

3.1 Dimension Drawing

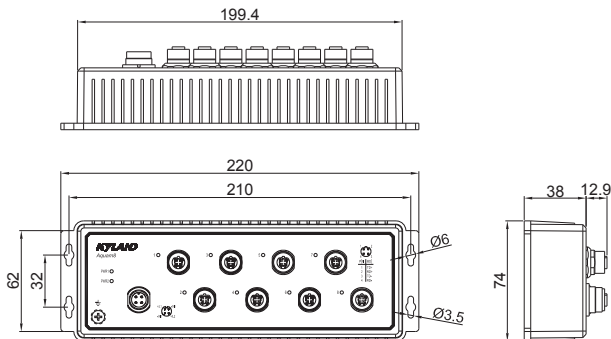

Figure 2 Dimensions (unit: mm)



Caution:

- As part of the heat dissipation system, the switch housing becomes hot during operation. Please use caution when coming in contact and avoid covering the switch housing when the switch is running.
- The figures in this manual are only for reference.

3.2 Mounting Modes and Steps

The series devices support panel mounting, and should be installed in the assembled cabinet that is “open type”. Before installation, make sure that the following requirements are met.

- 1) Environment: temperature (-40°C to 75°C), ambient relative humidity (5% to 95%, non-condensing).
- 2) Power requirement: The power input is within the voltage range of the switch.
- 3) Grounding resistance: <math><5\Omega</math>
- 4) No direct sunlight, distant from heat source and areas with strong electromagnetic interference.
- 5) Devices are to be installed in an authority certified IP54 rating or even higher cabinet and accessible only by the use of a tool.

6) Devices should be installed and accessed by service personnel or users who have been instructed about the reasons for the restrictions applied to the location and about any precautions that shall be taken.

● Mounting

Step 1: Select the mounting position (on a inner wall of a cabinet) for the device and guarantee adequate space and heat dissipation.

Step 2: Punch four holes in the selected position according to the dimensions of the device. Insert four screws into the four holes with a screwdriver until about a 5mm distance is left between each screw head and the wall of a cabinet.

Step 3: Align the four mounting holes on the plate for panel mounting with the four screws. Insert the screws through the $\Phi 6$ positions in the following figure. Move the device in direction 1 until the four screws are in the $\Phi 3.5$ positions. Then tighten the screws.

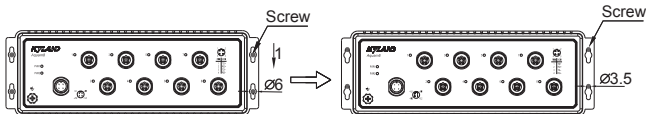

Figure 3 Panel Mounting

● Dismounting

Step 1: Loosen the screws with a screwdriver. Pull the device upward until the screws are in the $\Phi 6$ positions in the following figure. Then remove the plate for panel mounting from the screws to detach the device from the inner wall of the cabinet.

Step 2: Loosen the screws completely with a screwdriver. Remove them from the inner wall of the cabinet.

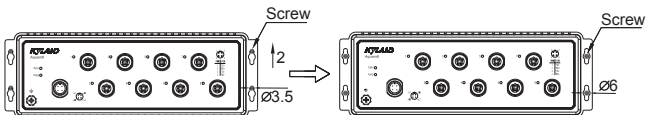

Figure 4 Panel Dismounting

**Caution:**

Cut off the power and disconnect all cables before mounting, dismantling or moving the equipment.

4 Connection

4.1 10/100Base-T(X) Ethernet Port

10/100Base-T(X) Ethernet port is equipped with M12 connector, which is dustproof, waterproof, and anti-vibration. The port is self-adaptive. It can automatically configure itself to work in 10M or 100M state, full or half duplex mode. The port can also adapt to MDI or MDI-X connection automatically. You can connect the port to a terminal or network device with a straight-through or cross-over cable.

- Pin Definition



Figure 5 M12 Port (female)

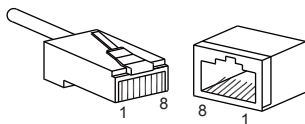



Figure 6 RJ45 Port

You can use an M12-M12 or M12-RJ45 cable to connect the port for communication. The preceding figures show the pin numbers of an M12 port and an RJ45 port. For pin definitions, see the following table.

Table 2 Pin Definitions of M12/RJ45 Port

Pin	MDI-X Signal	MDI Signal
M12 Port		
1	Receive Data+ (RD+)	Transmit Data+ (TD+)
2	Transmit Data+ (TD+)	Receive Data+ (RD+)
3	Receive Data- (RD-)	Transmit Data- (TD-)
4	Transmit Data- (TD-)	Receive Data- (RD-)
RJ45 Port		
1	Receive Data+ (RD+)	Transmit Data+ (TD+)
2	Receive Data- (RD-)	Transmit Data- (TD-)
3	Transmit Data+ (TD+)	Receive Data+ (RD+)
6	Transmit Data- (TD-)	Receive Data- (RD-)
4, 5, 7, 8	Unused	Unused
 Note: "+" and "-" indicate level polarities.		

● Wiring Sequence

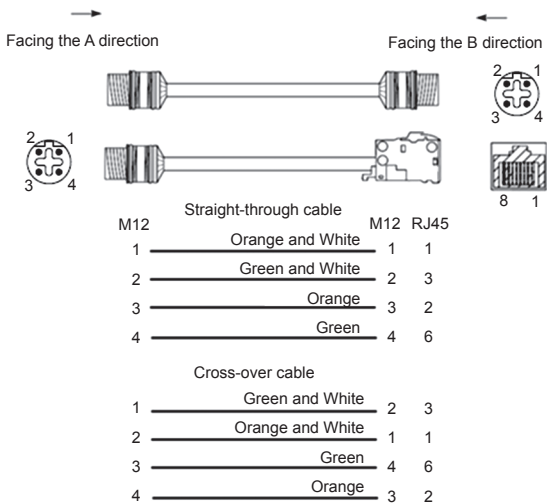

Figure 7 Connection Using Straight-through/Cross-over Cable

**Note:**

- The color of the cable for RJ45 connector meets the 568B standard: 1-orange and white, 2-orange, 3-green and white, 4-blue, 5-blue and white, 6-green, 7-brown and white, and 8-brown.
 - The 1 and 3, 2 and 4 pins on the M12 interface are differentiated signal pins in pairs. The orange-and-white and orange pair, green-and-white and green pair, blue-and-white and blue pair, and brown-and-white and brown pair in twist pair cables must be used in correct pairs while being connected with the signal pins. For example, the above figure, the orange-and-white and orange and green-and-white and green pairs are used.
-

4.2 Grounding

Grounding protects the device from lightning and interference. Therefore, you must ground the device properly. You need to ground the device before it is powered on and disconnect the grounding cable after the device is powered off. There is a grounding screw (see Figure 1) on the front panel of the device. The screw is for chassis grounding. After crimping one end of the grounding cable to a cold pressed terminal, secure the end of the grounding cable to the grounding screw and firmly connect the other end to ground.

**Note:**

- Cross-sectional area of the chassis grounding cable $>2.5\text{mm}^2$;
Grounding resistance $<5\Omega$.
 - Earth line should be less than 3m.
-

4.3 Power port

There is a power port on the front panel of the device. You need to connect the power cable to the power port to provide power to the device. Power port is equipped with M12 connector, which is dustproof, waterproof, and anti-vibration. The device supports redundant power input, when one power input is faulty, the device can continue operating properly, thereby improving network reliability.

**Note:**

$0.75\text{mm}^2 < \text{Cross-sectional area of the power cable} < 2.5\text{mm}^2$;
grounding resistance $< 5\Omega$.

● Pin Definition

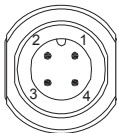

Figure 8 Power Port (male)

Table 3 Pin Definitions of Power Port

Pin	Signal	DC Wiring Definition	AC Wiring Definition
1	-/N1	PWR1: -	PWR1: N
2	+/L1	PWR1: +	PWR1: L
3	-/N2	PWR2: -	PWR2: N
4	+/L2	PWR2: +	PWR2: L

● Wiring and Mounting

Step 1: Ground the device properly according to section 4.2.

Step 2: Insert one end of the power cable into the M12 connector firmly.

Step 3: Insert the M12 connector with the connected cable into the power port on the device.

Step 4: Connect the other end of the power cable to an external power supply system according to the power supply requirements of the device. View the status of the power LED. If the LED is on, the power is connected properly.



Caution:

- Before connecting the device to power supply, make sure that the power input meets the power requirement. If connected to an incorrect power input, the device may be damaged.
- To comply with UL restrictions, this equipment must be powered from a source compliant with SELV.



Warning:

- Do not touch any exposed conducting wire, terminal, or component with a voltage warning sign, because it may cause personal injury.
- Do not remove any part or plug in or out any connector when the device is powered on.

5 LEDs

Table 4 Front Panel LEDs

LED	State	Description
Power 1 LED-PWR1	On	The power 1 is connected and operates properly.
	Off	The power 1 is not connected or operates abnormally.
Power 2 LED-PWR2	On	The power 2 is connected and operates properly.
	Off	The power 2 is not connected or operates abnormally.
Ethernet port connection status LED	On	Effective port connection
	Blinking	Ongoing network activities
	Off	No effective port connection

6 Basic Features and Specifications

Power Requirements		
Power Identifier	Rated Voltage Range	Maximum Voltage Range
LV	24VAC/DC(18-30VAC, 50/60Hz; 12-48VDC)	18-30VAC/9-60VDC
Terminal Block	4-pin M12 connector	
Rated Power Consumption		
Rated Power Consumption	4.6W (MAX)	
Physical Characteristics		
Housing	Metal, fanless	
Installation	Panel mounting	
Dimensions (W×H×D)	220mm×74mm×38mm (excluding connectors)	
Weight	0.75Kg	
Fastening Cover Version Torque	0.3 N•M	
Fastening Connector Nut Torque	1.3 N•M	
Environmental Limits		
Ambient Temperature	-40℃～+75℃	
Storage Temperature	-40℃～+85℃	
Ambient Relative Humidity	5%～95% (non-condensing)	
Altitude	2000m	
Pollution Degree	2	
MTBF		
MTBF	4381030h	
Warranty		
Warranty	Five years	

KYLAND

FAX: +86-10-88796678

Website: <http://www.kyland.com>

Email: support@kyland.com

For more information about KYLAND
products, please visit our website:

<http://www.kyland.com>