



atim cloud wireless™
PRODUCT LINE

ATIM Cloud Wireless

Ultrasonic distance measurement

LVL

User Guide



Concerned models:

ACW/SF8-LVL

ACW/LW8-LVL



ATIM Radiocommunications
Chemin des Guillets
38250 Villard de Lans

www.atim.com
info@atim.com



Table of contents

THIS USER GUIDE IS APPLICABLE TO THE FOLLOWING REFERENCES	4
DOCUMENT VERSION HISTORY	4
DISCLAIMER	5
TRADEMARKS AND COPYRIGHT	5
DECLARATION OF COMPLIANCE	6
ENVIRONMENTAL RECOMMENDATIONS	7
A. EXPLOSIVE ATMOSPHERE	7
B. ENVIRONMENT	7
C. RADIO	7
TECHNICAL SPECIFICATIONS	8
A. PRODUCT	8
SENSOR'S SPECIFICATIONS	8
CASING	9
A. FOOTPRINT	9
B. PRODUCT IDENTIFICATION	10
C. INSTALLATION AND DISMANTLING	11
D. INSTALLATION	11
E. MAGNET POSITION.....	13
OPERATING	14
A. OPERATING MODES	14
PRODUCT START-UP	15
TEST FRAME EMISSION.....	16
DEEP SLEEP SETUP	16
RADIO MODULE ACTIVITY	16
BATTERY PASSIVATION.....	16
ACW CONFIGURATOR.....	17
A. COMPATIBLE CONFIGURATOR VERSION	17
B. ACW-LVL SETUP	18
<i>Emission period and samples in the frame</i>	18
<i>Keep alive frame period</i>	18
<i>Frame timestamp</i>	19
<i>Configuration of the Radio module</i>	19
<i>Product versions</i>	20
<i>Sensor's configuration</i>	20
<i>Setup validation</i>	21
C. FACTORY SETTINGS.....	21
D. UPDATES OF ACW	22
FRAMES FORMAT	23
A. SIGFOX AND LoRAWAN	23
<i>Classic frame</i>	23
<i>Measurement frame</i>	24
<i>Alert frame</i>	25
<i>Keep-alive frame</i>	26
<i>Error frame</i>	27
EXAMPLES OF FRAMES	29
<i>Measurement frame</i>	29

<i>Alert frame</i>	29
DOWNLINK	30
A. CONFIGURATION OF THE FRAME PARAMETERS (SENDING PERIOD, NUMBER OF SAMPLES, ETC.).....	30
B. CONFIGURATION OF THE DISTANCE OFFSET PARAMETER.....	30
C. THRESHOLD SETUP	31
D. CONFIGURING SENSOR DETECTION THRESHOLDS.....	31
TECHNICAL SUPPORT	32

This user guide is applicable to the following references

	Product references	Product version (Visible on the label of the product)
LoRaWAN	ACW/LW8-LVL	A.2
Sigfox	ACW/SF8-LVL	A.2

Document version history

Version	Date	Description	Author	Software version
0.1	06/03/2020	Document creation	AC	V0.0.1
0.2	25/03/2020	Correction	AC	V0.0.1
0.3	10/12/2020	Correction of the description of the frame of downlink datalogging	AC	V0.0.2
0.4	03/02/2021	Addition of suggestions for mounting the case / updated description of the configuration page	AC	V0.0.3
1.0	03/02/2021	Correct downlink frame / change Error code / add mounting solutions	AC	V0.0.3
1.1	22/06/2021	Compatibility mode regarding repeaters LoRa/LoRaWAN and FSK/Sigfox description Modification of the operation mode description: LED behavior when searching for a network. Add guidance notes for samples sorting in periodic frame. Add more details for sensors technical specifications	AC	V0.0.4
1.2	02/12/2021	New product image, add sensors detection thresholds to downlink chapter	AC	V0.0.5
1.3	26/07/2022	Updating documentation to match the new design of the sensor	AJ	V1.0.3

Disclaimer

The information contained in this document is subject to change without warning and does not represent a commitment on the part of ATIM radiocommunications. ATIM radiocommunications provides this document 'as-is' with no warranty of any kind, express or implied, including but not limited to implied warranties of merchantability or fitness for a particular purpose. ATIM radiocommunications may make changes and/or improvements to this manual or to the product(s) or program(s) described in this manual, at any time.

Trademarks and copyright

ATIM radiocommunications®, ACW ATIM Cloud Wireless® and ARM Advanced Radio Modem® are registered trademarks of ATIM SARL in France. The other trademarks mentioned in this document are the property of their respective owners.

Declaration of compliance

All ACW Atim Cloud Wireless® products comply with the regulatory requirements of the R&TTE Directive (1999/5/EC), article 3:



1 SAFETY (Article 3.1a of the 1999/5/EC Directive)

NF EN60950-1 Ed. 2006/A1:2010/A11:2009/A12:2011 (health)

EN62479: 2010 (power <20mW) or EN62311:2008 (power > 20mW)

2 Electromagnetic compatibility (Article 3.1b of the 1999/5/EC Directive)

EN 301489-3 v1.4.1, EN 301489-1 V1.9.2

3 Efficient use of the radio frequency spectrum (Art.3.2 of the 1999/5/EC Directive)

ETSI EN300 220-2 v2.4.1 and EN300 220-1 v2.4.1

Environmental recommendations

a. Explosive atmosphere

Except for the ACW-ATEX line specifically intended for this purpose, **do not use** ACW radio modems in the presence of flammable gases or fumes. Using the equipment in such an environment constitutes a safety hazard.

b. Environment

Respect the temperature ranges for storage and operation of all products. Failing to respect these guidelines could disrupt device operation or damage the equipment. ACW products in IP65 water- and dust-resistant housings may be placed outdoors, but must not, under any circumstances, be submerged.

Follow the instructions and warnings provided below to ensure your own safety and that of the environment and to protect your device from any potential damage.



General hazard – Failure to follow the instructions presents a risk of equipment damage.



Electrical hazard – Failure to follow the instructions presents a risk of electrocution and physical injury.



WARNING: do not install this equipment near any source of heat or any source of humidity.



WARNING: for your safety, it is essential that this equipment be switched off and disconnected from mains power before carrying out any technical operation on it.



WARNING: the safe operation of this product is ensured only when it is operated in accordance with its intended use. Maintenance may only be performed by qualified personnel.



Waste disposal by users in private households within the European Union. This symbol appears on a product or its packaging to indicate that the product may not be discarded with other household waste. Rather, it is your responsibility to dispose of this product by bringing it to a designated collection point for the recycling of electrical and electronic devices. Collection and recycling waste separately at the time you dispose of it helps to conserve natural resources and ensure a recycling process that respects human health and the environment. For more information on the recycling center closest to your home, contact your closest local government office, your local waste management service or the business from which you purchased the product.

c. Radio

Modems in the ACW line are radio-communication modems that use the ISM (industrial, scientific and medical) bands, which may be used freely (at no cost and with no authorisation required) for industrial, scientific and medical applications.

Technical specifications

a. Product

Dimensions	100 x 100 x 40 mm	
Antenna	Internal	
Temperature	-25°C to +70°C (Operating mode) -40°C to +70°C (Storage mode)	
Casing	IP 54	
Battery	1x packs Lithium batteries	
Weight	300 g	
Frequency	865 – 870 MHz	
Power	25 mW (14 dBm)	
Rate	Sigfox: 100 bits/s LoRaWAN: 300 bits/s to 10 Kbits/s	
Consumption	Sigfox	LoRaWAN
Tx Mode	60 mA	55 mA
Sleep mode	30 µA	30 µA
Rx Mode	50 mA	25 mA

Sensor's specifications

Ultrasonic Sensor	Range	20 cm to 5 m
	Resolution	1 cm

Casing

a. Footprint

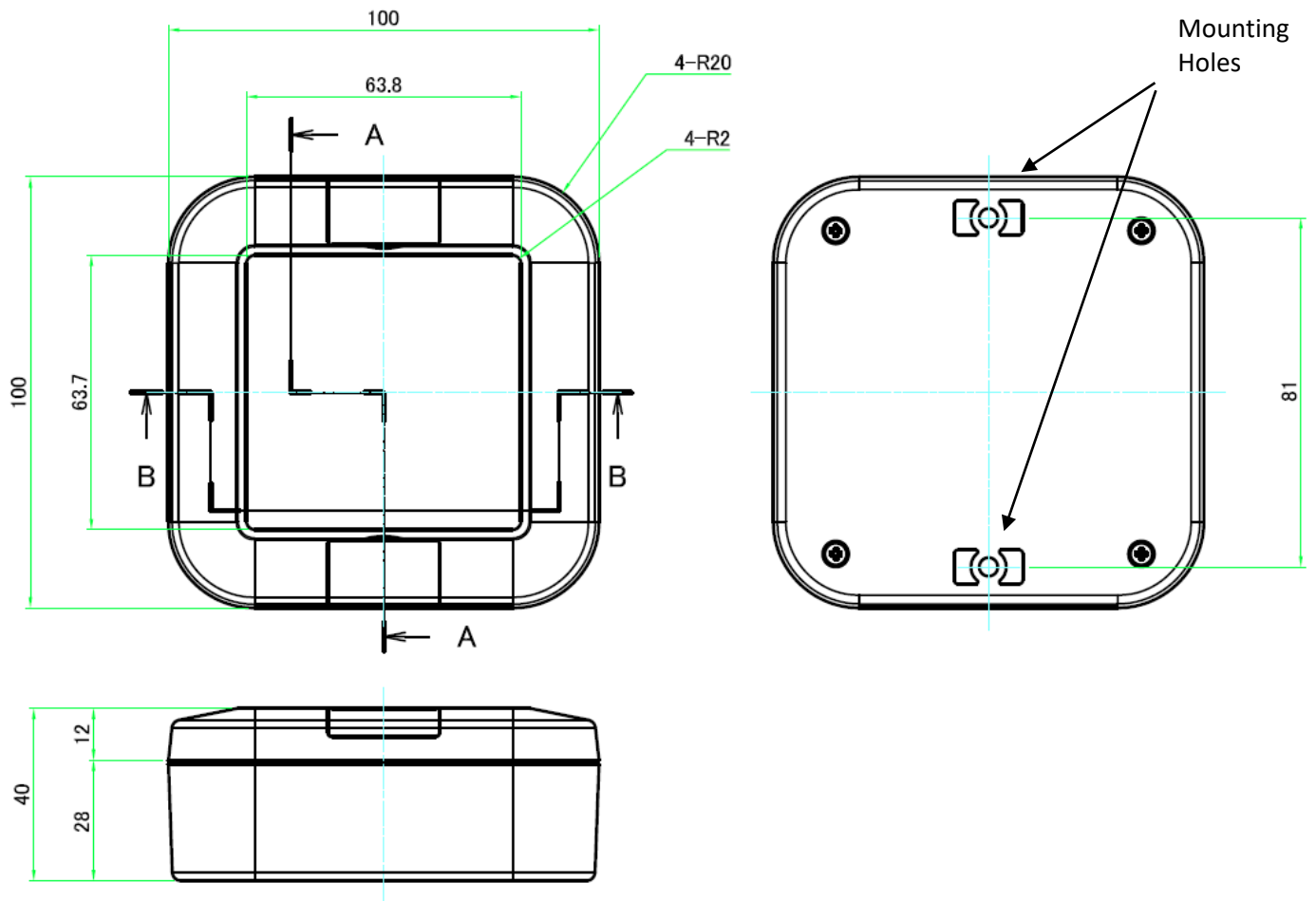

Dimensions are given in millimeters.

b. Product Identification

The Sigfox or LoRaWAN IDs of the product are visible on the outside label on the side of the product, inside on the electronic card, and in the status section of the ACW configurator.

For LoRaWAN modems, the communication keys are automatically given by the network (pairing by "Over The Air Activation", or OTAA).

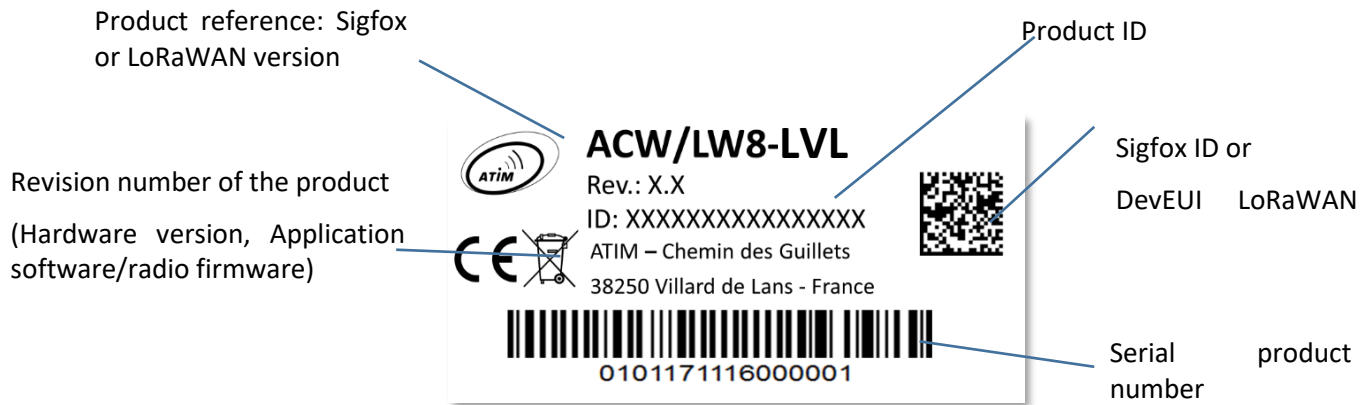

Reading this QR Code gives the following information

ATIM|ACW/LW8-LVL|C.0|190114|1|3.0|5.11|70B3D59BA0008C0A

Meaning

ATIM	ACW/LW8-LVL	C.0	190114	1	3.0	5.11	70B3D59BA0008C0A
Manufacturer name	Product name	Revision version	Assembly date	Assembly site	Hardware version	Firmware version	Sigfox ID or LoRaWAN DevEUI

c. Installation and dismantling

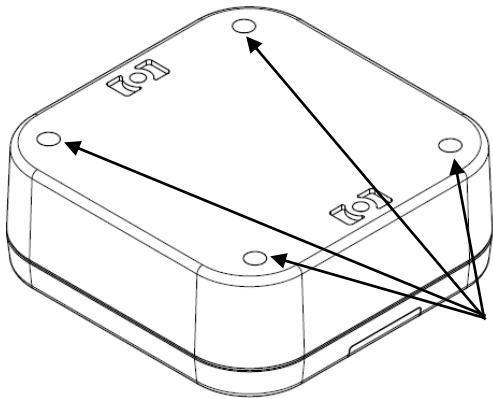

Screws to dismount the enclosure.

It is necessary to open the box to the micro-USB port allowing the configuration of the module.

To do this, you must unscrew the four screws which hold the top and bottom of the enclosure together.

d. Installation

The enclosure has 2 slots to screw the sensors. Those can be used to set it up using flat angle bracket, or on the top of a tank which has a hole on the top.

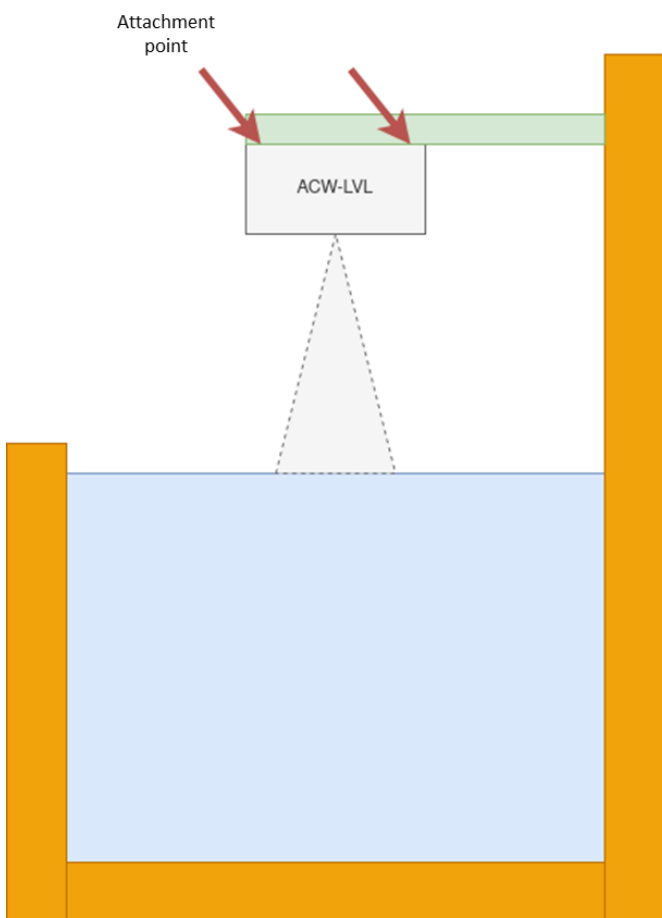

Mounting on angle bracket

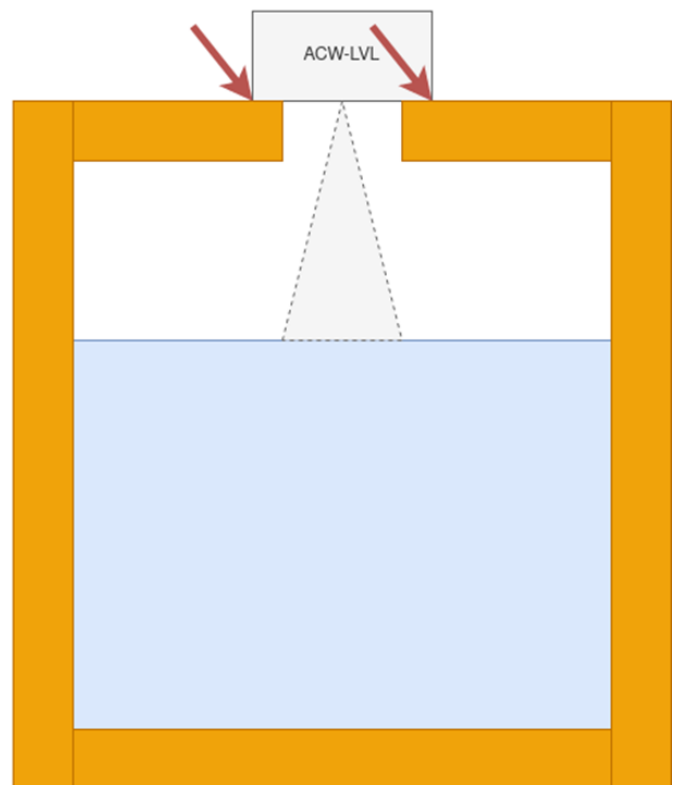

Mounting on tank

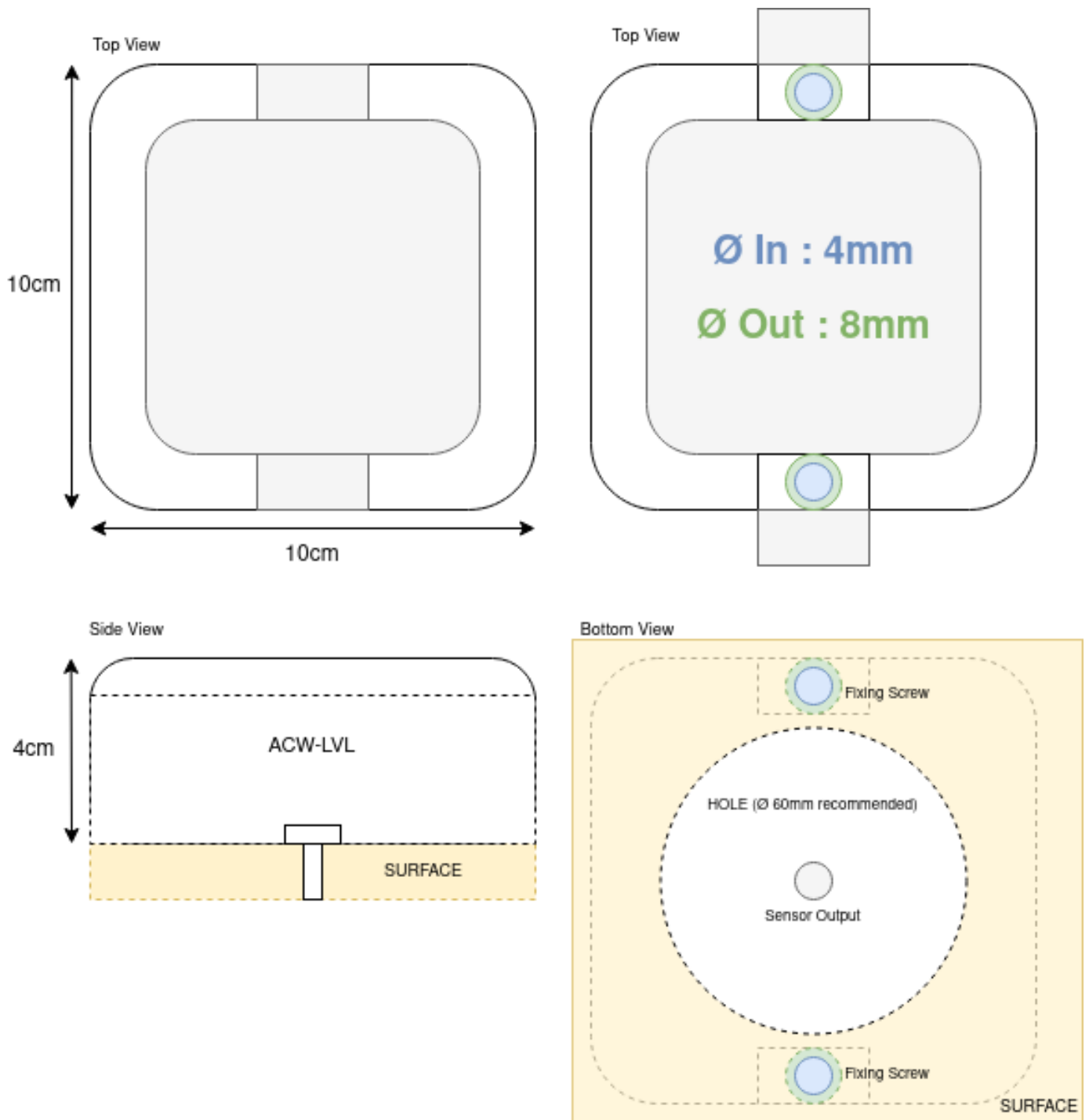

IMPORTANT NOTE

Avoid all kind of obstruction around the output of the sensor, especially in closed environments like a tank. A drilling of 60mm diameter is recommended.

WARNING

Take care about the size of the walls, the longer they are, the more interferences can happen. This can lead to false measurements or even prevent the sensors to work.

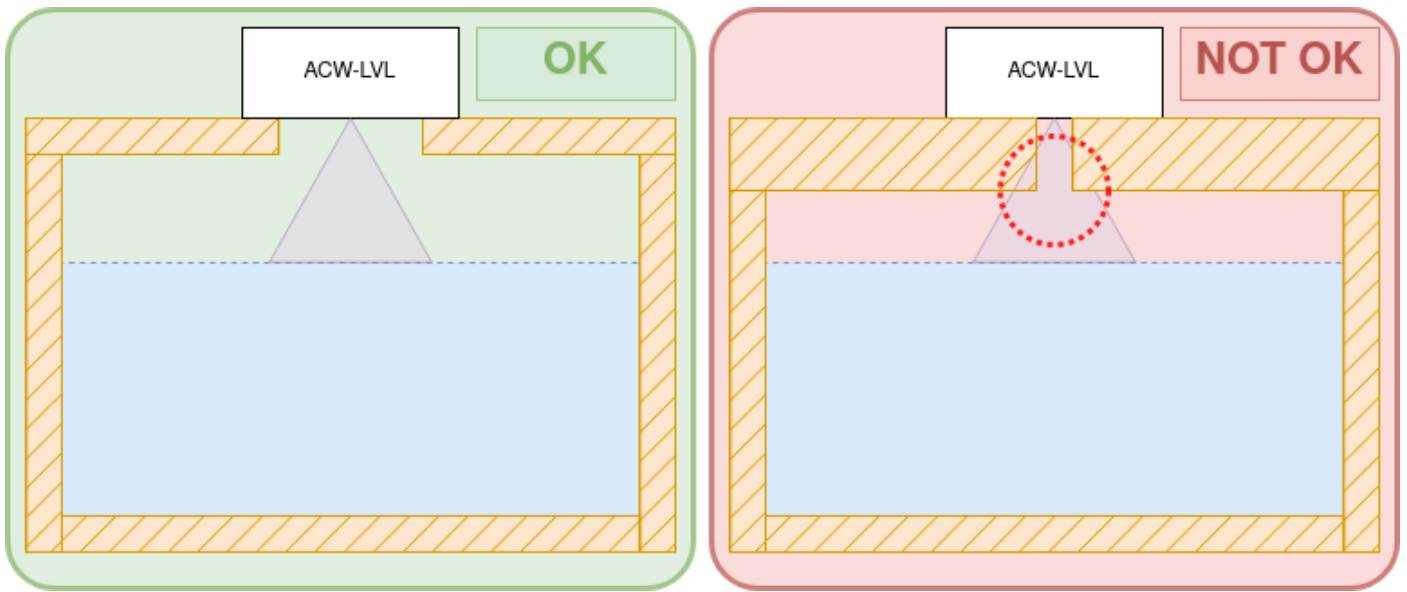

e. Magnet position

The magnet should be positioned on the left of the QR code of the left face, as shown in the following pictures:

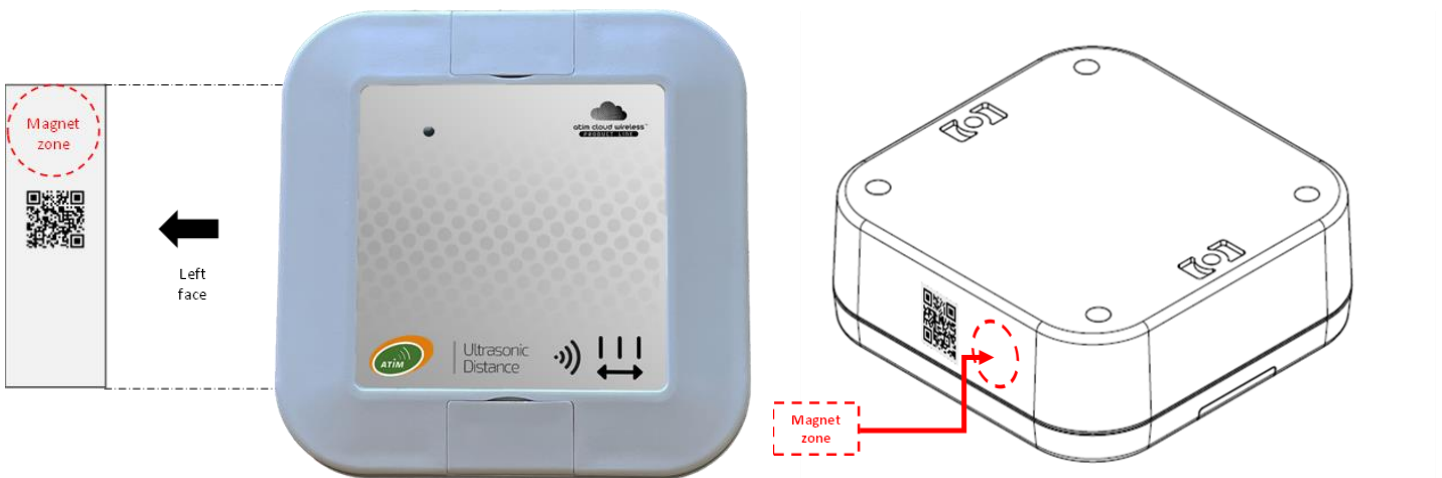

When the magnet will be mentioned in the following chapters, please refer to the image above to place the magnet correctly.

Operating

a. Operating modes

The operating of the ACW-LVL is divided between different modes:





- **Operation mode:** this is the default mode when starting the product. In this mode, the module periodically sends measurements according to the configuration applied (if the product has never been configured, the factory configuration applies, see [Factory settings](#)).
- **Deep sleeping mode:** this standby mode mainly allows you to put the product to sleep from the time it is put into service until it is installed on site. In this mode no measurement or radio communication functions are possible.
- **Configuration mode:** this mode is active FIVE minutes after exiting deep sleep mode and allows configuration of the product in **Bluetooth** using the PC configurator. In addition, radio frames are sent every minute (therefore five frames) to ensure that the product is properly commissioned. After these five minutes, the product returns to operating mode and **Bluetooth** is deactivated (possibility of reactivating it via **Downlink**).
- **Fault mode:** This mode allows the normal operation of the module to be interrupted when a critical event occurs. The nature of the event can be multiple:
 - Empty battery (battery voltage below 2.2V)
 - Error on the radio module
 - Error when automated tests
 - Error in the application

Entering Fault mode is indicated by a flashing **RED** LED of the product.

If the error does not come from the radio module, the product will send 3 radio frames every 24 hours containing the error code (s) (see [Frames format](#) for error codes). In addition, the product will emit a luminous warning depending on the nature of the event.

Once in this mode, the module must be restarted (by disconnecting and reconnecting the battery, by a Downlink command or with the magnet) to return to its normal operation.

At any time, it is possible to identify which mode the product is in by bringing a magnet **at least for 2 seconds** to the side of the case. The product led will light up in one of these colours depending on the mode:

-  for operating mode
-  for configuration mode
-  for deep sleep mode
-  for fault mode
-  for the pairing mode

Product start-up

In most cases, the ACW-LVL is started up before delivery (battery packs already connected) and then placed in deep standby to limit consumption.

To place the product in its operating mode, bring a magnet close to the side of the case for 6 seconds. During these **6 seconds**, the product LED should flash **WHITE** and then **GREEN** after six seconds to indicate that the product has started up.

The ACW then enters the network pairing phase. During this phase, a **FUSCHIA** light signal with a fading effect indicates that the search phase is in progress.

If the connection is successful, the product will emit a light signal depending on the quality of the network:

- **GREEN** light signal: good quality of network
- **YELLOW** light signal: low quality of network
- **ORANGE** light signal: bad quality of network
- **WHITE** light signal: no information on the quality of the network

The module will then enter its operating mode and start to send information to the network depending on the configuration.

Particular cases

- For a Sigfox device
 - To retrieve network quality for Sigfox devices, it is necessary to provision a Downlink. It is this one which will make it possible to determine the quality of the network. The product emits at startup, a test Uplink described in the chapter Classic frame (frame type 0x02). If a Downlink is provisioned, the information on network quality will then be relayed by the ACW (light signal). If no Downlink is provisioned, the ACW will always display a **WHITE** light signal.
 - If a **WHITE** light signal at the end of 5 minutes of the pairing phase is emitted by the product **AND** a Downlink has been provisioned, this therefore means that the Network is not accessible.
 - If a **WHITE** light signal at the end of the 5min pairing phase is emitted by the product **WITHOUT** a Downlink having been provisioned, this has no meaning for the quality of the network. The quality of the network can be good as well as bad (or non-existent).
- For a LoRaWAN device
 - In the default LoRaWAN Class A operating mode, (see chapter Radio Parameters), if at the end of the 5 minutes of the pairing phase, no network has been reached, then the product goes into standby and will restart a pairing phase of 5 minutes 24 hours later. So, if the product is placed in an area not yet covered by a network, the product will join it when connectivity is possible.
 - In the LoRa / LoRaWAN Repeater Compatibility operating mode, (see chapter Radio Parameters), if at the end of the 5 minutes of the pairing phase, no network has been reached, then the product emits a **WHITE** light signal and enters its nominal operating mode. Even if no network has been reached, it is assumed with this mode that an ATIM LoRa / LoRaWAN repeater located nearby will be able to repeat the Local frames sent by the product in LoRaWAN frame on the network that the repeater will have joined.

Test frame emission

When the product is in its operating mode (and only in this mode), it is possible to send a test frame (which avoids waiting for the next measurement frame) including a measurement sample.

To do this, simply bring the magnet closer until the **GREEN** light signal goes out. The successful sending of the test frame will be indicated by a **CYAN** light signal.

Deep sleep setup

While transporting or storing the ACW-LVL, it is best to place it in its deep sleep mode to limit unnecessary energy consumption.

From any operating mode (except fault mode), bring a magnet near the diamond marking on the box for **6 seconds**.

During these six seconds, the LED of the product will flash in the colour corresponding to the operating mode then the end of the sequence will be indicated by a **WHITE** fade acknowledging that the product has been put on standby. The magnet can therefore be removed.

Radio module activity

Any sending of a radio frame is indicated by three brief **GREEN** flashes of the LED.

Battery passivation

The ACW-TMXP incorporates a battery depassivation feature, to limit the phenomenon of battery passivation during prolonged phases of deep standby. This feature is automatically activated as soon as the product goes into its deep sleep mode. The product will then wake up once a day to start the battery depassivation sequence, then the product will automatically return to deep standby.

ACW configurator

a. Compatible configurator version

For an LVL with the following application software version:	Use the version of ACW Configurator:
Sigfox: V0.0.1 LoRaWAN: V0.0.1	V4.5.8 or later

Download and install the configuration software setup 'setupACW.exe' at:

<https://www.atim.com/en/products-configurator/>

NOTE

The ACW-LVL can be configured only from its **configuration** mode (otherwise the ACW configurator cannot detect it). To enter configuration mode, the device must enter its deep sleep mode first (magnet for 6 seconds), wait approximately 20 seconds for the entry to be effective and then wake up the device (magnet for 6 seconds again).

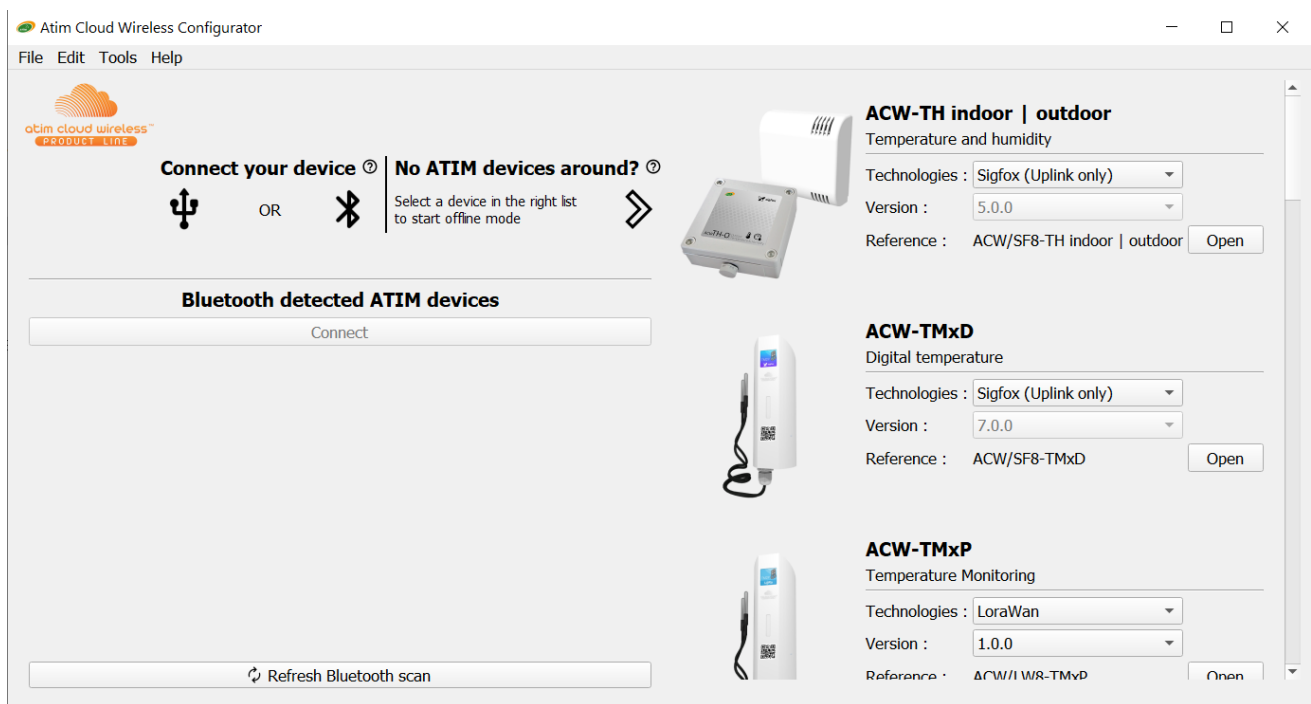

Pairing the ACW-LVL with the configurator can be done in two ways:

- **By USB:** open the case of the ACW-LVL and connect it to a computer with a micro-USB cable.
- **By Bluetooth:** make sure that Bluetooth is activated.

WARNING

Do not leave the product connected to the configurator (via USB or Bluetooth) unnecessarily, otherwise the autonomy of the product will be seriously degraded.

b. ACW-LVL setup

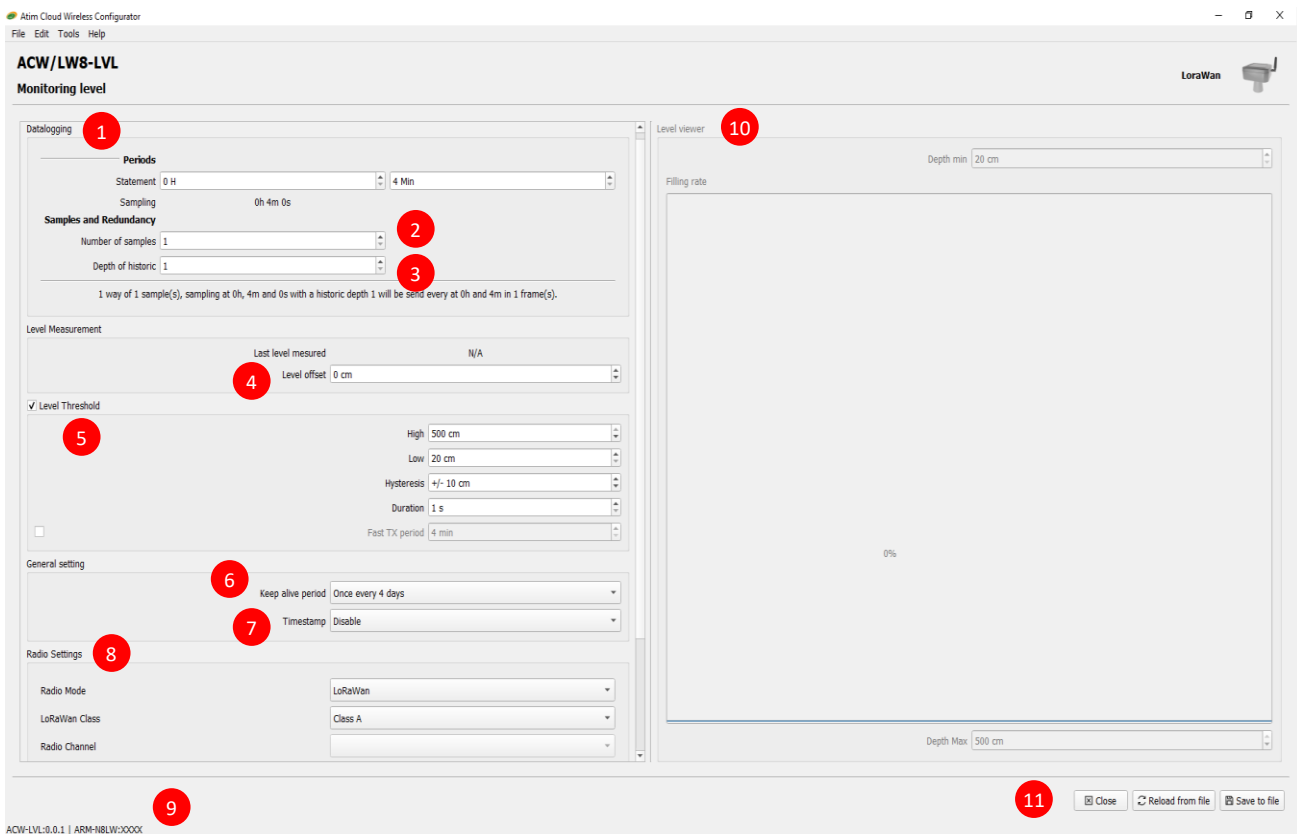

Emission period and samples in the frame

The transmission period **1** corresponds to the time interval between each sending of a measurement frame. This period can be configured from 10 min to 255 h and its default value is 1 hour.

In addition, it is possible to configure the number of samples in a frame **2**. Thus, several measurements will be carried out before the sending of the frame which will contain all these measurements.

For example, with a period of 12 minutes and several samples of 4, a measurement will be made every 3 minutes and the 4 samples will be sent in a single frame every 12 minutes.

Finally, it is possible to apply a redundancy of the data **3**, which means that samples having been sent in the frame n-1, n-2 or n-3 could be sent again in the frame n to the continuation of the new measurement samples (the most recent sample first in the frame and the least recent last).

For example, for a history depth of 3, the data of the last 2 frames will be sent, in addition to the new data, in the next frame.

Keep alive frame period

A life frame can be sent periodically **6**. This frame will raise the supply voltage of the product.

The value of this period can be configured from 1 hour to 1 month. By default, the value is set to 4 days.

Frame timestamp

It is possible to deactivate / activate the time stamping of all radio frames ⁷.

WARNING

This option when activated monopolizes 4 bytes in the frame which cannot be used for useful data.

Configuration of the Radio module

The device can work in 3 different operating modes ⁸:

- For a LoRaWAN device:

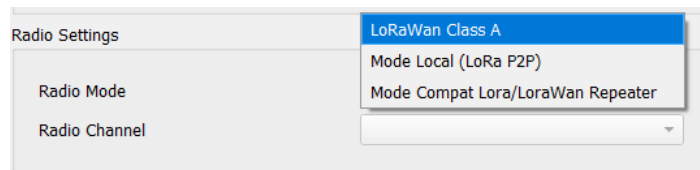

- **LoRAWAN Class A** (default): The product is modulated in LoRa and uses the LoRAWAN Class A protocol. This is the product's default mode. This mode requires a private LoRAWAN network (private gateway), or an operated network to view the data sent by the product.
- **Local mode** : Product modulation remains LoRa modulation. However, there is no LoRAWAN overlay. In this mode, you must choose the radio channel on which the product will transmit. To be able to receive the product frames, a radio modem with the same parameters is then required. This mode has no real concrete use case for the moment, but future developments of this mode will provide interesting point-to-point features.
- **Compatibility mode with the ATIM LoRa / LoRAWAN Repeater**: This mode should be selected when you want to operate in classic LoRAWAN, but no network (private or operated) is accessible. This mode, associated with the ATIM LoRa / LoRAWAN Repeater, then makes it possible to join the LoRAWAN network through this repeater. In this mode, if the network is not joined (no JOIN_ACCEPT), then the product will send its frames locally. The LoRa / LoRAWAN repeater then relays these frames on the network that it has joined (the repeater must be placed at a location with connectivity to the desired network).

IMPORTANT NOTE

If the product has access to the LoRAWAN network, the default operating mode (LoRaWAN Class A) must be used. If this mode is chosen, while the network is accessible, the product will still send a frame over the LoRAWAN network and this same frame in Local mode to the Repeater, which will consume battery unnecessarily.

- For a Sigfox device:

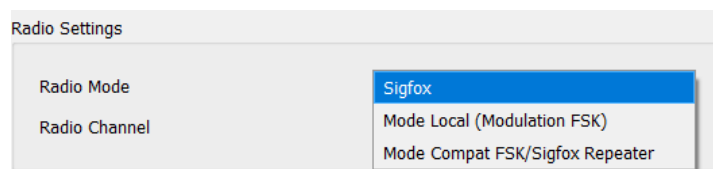

- **Sigfox** (default): Modulation and Sigfox Protocol used. This is the product's default mode. This mode requires access to the Sigfox network to operate.

- **Local mode:** The modulation of the frame's switches to FSK. In this mode, you must choose the radio channel on which the product will transmit. To be able to receive the product frames, a radio modem with the same parameters is then required. This mode has no real concrete use case for the moment, but future developments of this mode will provide interesting point-to-point features.
- **Compatibility mode with the ATIM FSK / Sigfox Repeater:** This mode should be selected when you want to operate in Sigfox, but the network is not accessible. This mode, associated with the ATIM FSK / Sigfox Repeater, then makes it possible to join the Sigfox network through this repeater. In this mode, the product transmits these frames both on the Sigfox network and in Local (FSK modulation). The FSK / Sigfox repeater then relays these frames on the Sigfox network (The repeater must be placed in a location where the Sigfox network is accessible).

NOTE IMPORTANTE

If the product has access to the Sigfox network, the default operating mode (Sigfox) must be used. If this mode is chosen, the product will always send a frame on the Sigfox network and this same frame in Local mode to the Repeater, which will consume battery unnecessarily.

Product versions

When connecting to the product, the configurator retrieves all the software versions of the product (product software and radio module software) as well as the network identifier 9.

Sensor's configuration

10

Last Level Measured : Live measure

Level Offset : Allow the sensor to set an constant offset on all measures

Level Threshold : Create Measure Thresholds, the sensors will send an alarm frame if they are exceeded

Level Viewer : Emulate the filling of a tank according to specified parameters.

Detection threshold

Threshold up to range (cm)	Amplitude
30	10000
100	5000
200	3000
300	1000
400	400
500	200

Detection Threshold - Advanced configuration:

Set up multiple sensitivity levels on different ranges to optimise the measurements and/or ignore some obstacles which are outside the measure range set by the user

For each range, if the reflected signal is higher than the amplitude set up, then it's used to compute the distance. If multiples peaks happens, the closer one is used

Setup validation

After having filled in all the configuration parameters, it is essential to click on the "Apply to ACW" button to send the configuration to the product 11.

It is also possible at any time to read the current configuration of the product which will update the parameters on the configurator or to reset the default configuration of the product.

WARNING

Once the configuration is complete, do not leave the module connected via USB. This operating mode is very energy intensive. When you remove the USB link without disconnecting the battery, the module automatically returns to normal operation.

c. Factory settings

Radio frames settings:

- Radio frame emission period: 10 minutes
- Number of samplings: 1
- History depth: 1

General settings:

- Keep alive frame emission period: 4 days
- Timestamp: disabled
- Radio parameters: LoRaWAN Class A (for a LoRAWAN product) / Sigfox (For a Sigfox product)

Sensor's parameters:

- Level offset: 0 cm

Threshold parameters

- Threshold Enable
- High: 800 cm
- Low: 20cm
- Hysteresis: +/- 10 cm
- Duration: 1 second

d. Updates of ACW

When connected with Bluetooth Low Energy to the product, it is possible to update the different software that composes it.

To do this, go to the menu *Tools->Updater (CTRL+U)*

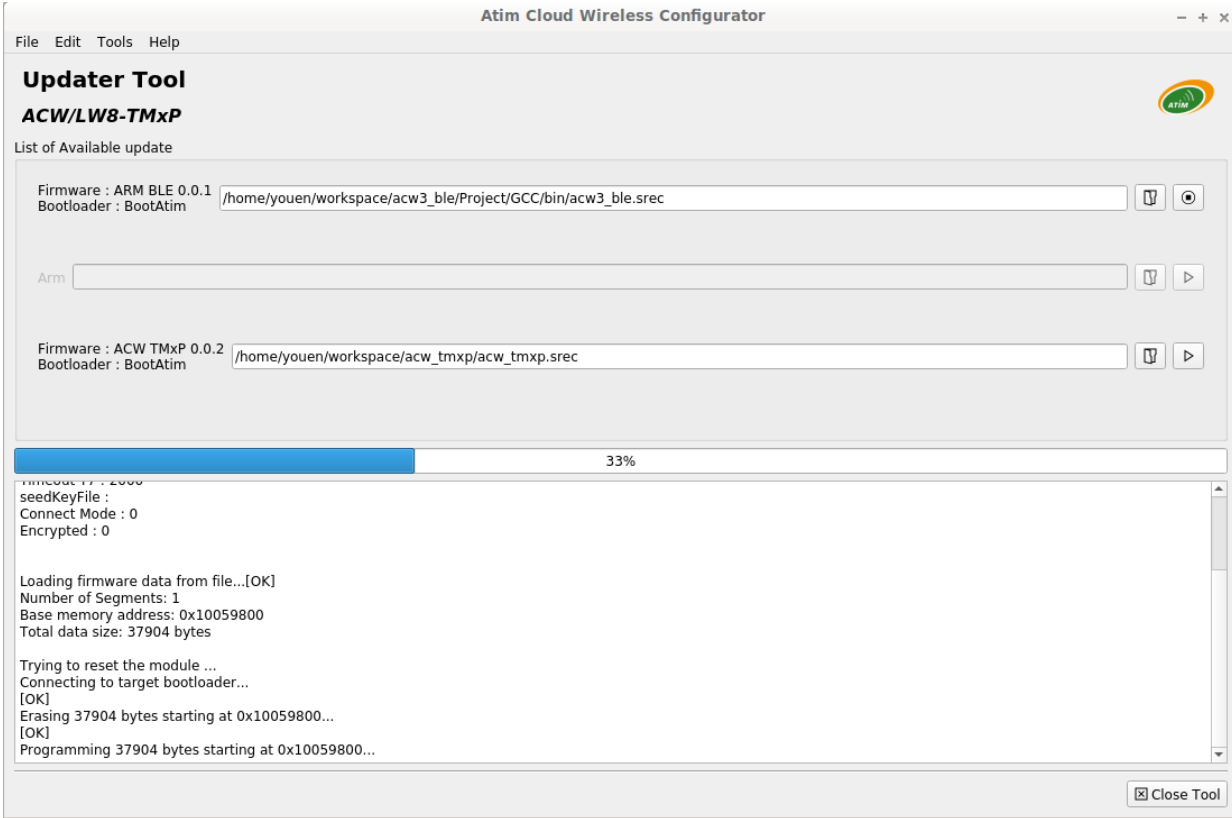

Frames format

a. Sigfox and LoRaWAN

Uplink frame			
Byte 1	Byte 2	...	Byte n
Frame header	Frame-specific data		

We can differentiate three types of frames:

- **Classic frame; New generation:** Very close to the old frames, the difference is that you can activate the timestamp. These are for example the life frame, the error frame, the response to configuration frames, ... These last frames are common to all ACWs but, it is also possible to have other independent frames for each ACWs.
- **Measurement frame; New generation:** These frames consist of samples of the different values of each of the channels that an ACW can read. Beforehand, the number of samples and the depth of the history will be inserted in the header.

NOTE

The number of samples and the depth of the history are in common for all the channels of the frame

- **Alert frame (threshold crossing); New generation:** These frames combine a conventional frame and a measurement frame. They consist of a header warning that a threshold has been exceeded, followed by samples of each of the channels for which a threshold has been exceeded.

Classic frame

Byte 1 - header							
Bit 7	Bit 6	Bit 5	Bit 4	Bit 3	Bit 2	Bit 1	Bit 0
New generation = 1	Timestamp = 1 - enabled 0 - disabled	Measurement frame = 0	Reserved = 0	Type of frame			

If Timestamp is enabled, 4 bytes with the value of the Timestamp will precede the header (byte 1).

Different type of frames:

Frame type	Size of data	Descriptions
0x00	--	Reserved
0x01	5 bytes	Keep alive frame
0x02	0 byte	Downlink request for network testing
0x03	8 bytes	Reserved
0x04	--	Reserved
0x05	1 byte	Test frame with counter
0x06	Variable	(Cfg box) Response to a setup frame.
0x07	Variable	(Cfg box) Response to a command frame.
0x08	Variable	(Cfg box) Response to an incorrect frame.
0x09	--	Reserved
0x0a	--	Reserved
0x0b	--	Reserved
0x0c	--	Reserved
0x0d	Variable	Alert measurement frame (threshold crossing or back to normality), sampling follow up of each channel in alert
0x0e	Variable	General error - (see page 23)
0x0f	Variable ...	Subframe for ACW. Depending on the ACW

Measurement frame

Byte 1 - Header							
Bit7	Bit6	Bit5	Bit4	Bit3	Bit2	Bit1	Bit0
New generation = 1	Timestamp	Measurement frame = 1	History depth (-1) Max: 4		Number of samplings (-1) Max: 8		

If the Timestamp is enabled, 4 bytes with the Timestamp value will be preceded by the header (byte 1).

WARNING

If Depth of history or Number of samplings is greater than 1, the frame emission period will be added after header (byte 1) on two bytes (Little Endian encoding, LSB first)

For each channel, a header is inserted afterwards and is constituted as follows:

Channel header							
Bit7	Bit6	Bit5	Bit4	Bit3	Bit2	Bit1	Bit0
Reserved = 0		Channel's number		Type of measurement			

In the case of ACW-LVL, **the measurement type** is 0x07 on 2 bytes for the distance in centimetres.

In the case of the ACW-LVL, there is only 1 way (i.e. 1 sensor) the channel's number will always be 0.

Type of measurement	Units	Data size	Data type	Descriptions
0x07	cm	2 bytes (Little Endian – LSB first)	Signed integer	Distance in centimetres <ul style="list-style-type: none"> ➤ Resolution: 1cm ➤ Max value: 32767cm ➤ Min value: 0 cm

Then follow the data of the measurement sample(s) (depending on the configuration of the product).

NOTE

When the frame contains several samples (number of samplings > 1 or depth history > 1), the samples are sorted from the latest to the oldest.

The number of bytes sent can be determined as follows:

$$(\text{Size in bytes of the measure}) * (\text{number of samplings}) * (\text{depth history})$$

EXAMPLE

Par exemple, pour le type de mesure 0x07 (la taille d'une valeur est de deux octets) avec une profondeur d'historique de 2 et un nombre d'échantillons de 3, la taille des données à lire serait de 12 octets (2x2x3).

Alert frame

Byte 1 - Header							
Bit7	Bit6	Bit5	Bit4	Bit3	Bit2	Bit1	Bit0
New generation = 1	Timestamp	Measurement frame = 0	Reserved = 0	Alert frame = 0x0d			

If the Timestamp is activated, 4 bytes with the Timestamp value will be preceded by the header (byte 1).

For each of the channels in alert a header is inserted and is constituted as follows:

Channel Header							
Bit7	Bit6	Bit5	Bit4	Bit3	Bit2	Bit1	Bit0
Alert type		Channel's number		Measurement type			

The type of alert field is used to identify whether it is a breach of the high threshold, the low threshold, or a return between the thresholds.

These values are defined as follows:

Value	Description
0x00	In between thresholds
0x01	Exceeding the high threshold
0x02	Exceeding the low threshold
0x03	Reserved

The measurement type field is identical here to the measurement frame (i.e. 0x07 in hexadecimal for the ACW-LVL).

The sample that caused the alert is then inserted afterwards.

Keep-alive frame

The life frame is sent at regular intervals according to the configuration applied (by default 4 days) and contains the battery levels of the product when empty (the product does nothing) and when charging (the product is transmitting a frame radio).

Byte 1 - Header							
Bit7	Bit6	Bit5	Bit4	Bit3	Bit2	Bit1	Bit0
New generation = 1	Timestamp = 0	Measurement frame = 0	Reserved = 0	Keep-alive frame = 0x01			

Following this header are 4 bytes, 2 for the empty battery level and 2 for the charging battery level.

The frame is therefore split as follows: 0xAABBBBCCCC

0xAA being the frame header (always equal to 0x81), 0BBBB the empty battery level (value in millivolts, MSB coding) and 0CCCC the charging battery level (value in millivolts, MSB coding)

EXAMPLE

0x81 0d24 0c68

0d24 : empty battery level = 3364 mV or 3.364 V

0c68 : battery charge level = 3176 mV or 3.176 V

Error frame

byte 1 - Header							
Bit7	Bit6	Bit5	Bit4	Bit3	Bit2	Bit1	Bit0
New generation = 1	Timestamp	Measurement frame = 0	Reserved = 0	Error frame = 0x0e			

If the Timestamp is activated, 4 bytes with the Timestamp value will be preceded by the header (byte 1).

For each error message, a header is inserted and is formed as follows:

Error frame header							
Bit7	Bit6	Bit5	Bit4	Bit3	Bit2	Bit1	Bit0
Message index				Length of the error frame			

The **message index** field is used to prioritize messages when several errors occur.

The **length of the error message** field indicates the size in bytes of the error message.

The following byte identifies the nature of the error that occurred:

Error code	Type of error	Description
0x81	ERR_UNKNOWN	
0x82	ERR_BUF_SMALLER	The data table is full, impossible to write any additional data
0x83	ERR_DEPTH_HISTORIC_OUT_OF_RANGE	The history depth is too large or too small for the frame
0x84	ERR_NB_SAMPLE_OUT_OF_RANGE	The number of sampling is too large or too small for the frame
0x85	ERR_NWAY_OUT_OF_RANGE	The number of the channel in the header of the frame is too large or too small
0x86	ERR_TYPEWAY_OUT_OF_RANGE	The type of measurement in the frame header is too large or too small
0x87	ERR_SAMPLING_PERIOD	Bad structure of sampling period
0x88	ERR_SUBTASK_END	End of a sub-task after leaving an infinite loop
0x89	ERR_NULL_POINTER	Pointer with value "NULL"
0x8A	ERR_BATTERY_LEVEL_DEAD	Critical battery level
0x8B	ERR_EEPROM	EEPROM is corrupted
0x8C	ERR_ROM	ROM is corrupted
0x8D	ERR_RAM	RAM is corrupted
0x8E	ERR_ARM_INIT_FAIL	Radio module initialization has failed
0x8F	ERR_ARM_BUSY	The module is already busy (possibly not initialized)
0x90	ERR_ARM_BRIDGE_ENABLE	The module is in bridge mode, cannot send data by radio
0x91	ERR_RADIO_QUEUE_FULL	Radio queue is full
0x92	ERR_CFG_BOX_INIT_FAIL	Error during black box initialization

0x93	ERR_KEEP_ALIVE_PERIOD	Wrong keep alive frame structure
0x94	ERR_ENTER_DEEP_SLEEP	The device entered deep sleep mode
0x95	ERR_BATTERY_LEVEL_LOW	Low battery
0x96	ERR_ARM_TRANSMISSION	A transmission has been initiated but an error has occurred
0x97	ERR_ARM_PAYLOAD_BIGGER	Message size is too large for the capacity of the network
0x98	ERR_RADIO_PAIRING_TIMEOUT	Impossibility to pair to a network within the fixed period
0x99	ERR_SENSORS_TIMEOUT	A timeout has been reached out on the sensor

Only codes 0x8A and 0x95 are followed by additional data corresponding to the battery level in millivolts. This value is coded in two bytes, the most significant byte first (MSB)

WARNING

For codes ranging from 0x81 to 0x92, the product will enter its FAULT mode and will no longer perform its measurement function. For codes ranging from 0x93 to 0x9D, these correspond only to alarms, so the product continues to operate normally.

Examples of frames

Measurement frame

Measurement frame without time stamp, no history and a sample number of 1.

Byte 1	Byte 2	Byte 3	Byte 4
0xA0 (new generation measurement frame, no history, 1 sample)	0x07 (channel 0, measurement type: distance)	0x01	0x22

In this frame the sensors returned the value 0x0122 (290 centimetres)

Measurement frame without time stamp, no history and a sample number of 2.

Byte 1	Byte 2	Byte 3	Byte 4	Byte 5	Byte 6	Byte 7	Byte 8
0xA1 (new generation measurement frame, no history, 2 samples)	0x003C Radio transfer period	0x07 (channel 0, measurement type: distance)	0x01	0x22	0x01	0x75	

The bytes 2 and 3 notify the radio transfer period, here 60 minutes (i.e. 1 sample measured each 30 minutes)

The two samples returned are 0x0122 (290 centimetres) and 0x0175 (373 centimetres).

Alert frame

For exceeding the threshold value defined:

Byte 1	Byte 2	Byte 3	Byte 4
0x8D (new generation alert frame)	0x47 (Exceeding high threshold channel 0, distance measurement)	0x01	0xAF

The sample that triggered the threshold on channel 0 is 0x01AF (431 centimetres).

Downlink

This functionality is available on ACW-LVL fulfilling the following conditions:

	Application software:	Radio firmware:
Sigfox version	V0.0.1	V5.9.3.1
LoRaWAN version	V0.0.1	V5.1.1

The operation of the Downlink is explained in the document ATIM_ACW-DLConfig_UG, relating to version V1.2.0 of the ATIM Downlink Protocol (To obtain this document, please fill the contact form at this address: <https://www.atim.com/en/technical-support/>).

The parameters specific to ACW-LVL are as follows:

a. Configuration of the frame parameters (sending period, number of samples, etc.)

Parameter code (Byte 1)	Frame size (Byte 2)	Index (Byte 3)	Parameter value (byte 4)	Parameter value (byte 5)	Parameter value (byte 6)
0xD4	0x04	0x00	0b00YY0ZZZ	0xYY	0xZZ

For byte 4, the two bits YY correspond to the history depth (max = 3) and the three bits ZZZ correspond to the number of samples per frame (max = 7).

Bytes 5 and 6 correspond to the period for sending a frame (= 0xYYZZ) ranging from 1 minute to 255 hours (15,300 minutes).

EXAMPLE

Byte 4 = 0x13

4 samples per frame + addition of the four samples sent to the previous frame.

Byte 5 = 0x3C and byte 6 = 0x54

Emission period = 0x0254 = 596 minutes

b. Configuration of the distance offset parameter

Parameter code (Byte 1)	Parameter value (Byte 2)
0x16	0xYY

The value of byte 2 is the offset in cm from -20 to + 20 cm in hexadecimal.

c. Threshold setup

Parameter code (Byte 1)	Frame size (Byte 2)	Index (byte 3)	Byte 4	Byte 5	Byte 6	Byte 7	Byte 8	Byte 9	Byte 10
0xD5	0x08	0x00	High threshold		Low threshold		hysteresis		Duration

For the threshold setup, the byte 0 is the header for an extended downlink frame + the number of the parameter (0xC0 | 0x15).

The byte 2 indicates the size of the following data.

Bytes 4 and 5 holds the high threshold value in centimeters (byte 4 = LSB, byte 5 = MSB)

Bytes 6 and 7 holds the low threshold value in centimeters (byte 6 = LSB, byte 7 = MSB)

Bytes 8 and 9 holds the hysteresis value in centimeters (byte 8 = LSB, byte 9 = MSB)

Byte 10 holds the duration value.

d. Configuring sensor detection thresholds

The sensor allows the configuration of detection thresholds to customize the sensor's detection capability according to the environment. In operation, each measurement made is compared to the corresponding threshold, if the signal received is sufficiently strong (above the defined threshold) the sensor considers that it is an object to be detected.

Six thresholds can be configured, each containing a distance value (the effective range for each threshold starts from this distance, up to the distance defined at the next threshold) and a signal amplitude.

The configuration frame is as follows:

Parameter code (byte 1)	Octet 2	Octet 3	Octet 4	Octet 5
0x98 (threshold 1)	Distance (in cm) from the threshold (LSB first)		Amplitude du signal (LSB first)	
0x99 (threshold 2)				
0x9A (threshold 3)				
0x9B (threshold 4)				
0x9C (threshold 5)				
0x9D (threshold 6)				

Bytes 2 and 3 correspond to the distance value (in cm) at which the threshold range starts, the upper limit of the threshold being the distance set at the next threshold. The data is encoded in "LSB first". For example, for 320 cm the value in hexadecimal will be 0x0140, byte 2 will have the value 0x40 while byte 3 will have the value 0x01. This value can range from 0 to 500.

Bytes 4 and 5 contain the minimum signal amplitude value for this distance range before the sensor interprets this value as an object to be detected. Here too the data is encoded in "LSB first". This value can be between 0 and 65534.

Technical support

For any further information or technical question, you can open a ticket on our [technical support dedicated webpage](#).

