

CCE-26.600 G



- standard pressure transmitter
- nominal pressure: from 0...1 bar up to 0...400 bar
- output signals: 2-wire: 4...20 mA; 3-wire: 0...10 V / 0...5V / 1...5V / 4...20 mA / 0...20 mA / ratiometric
- ceramic sensor
- accuracy 0.5 % span
- option: oil and grease free version



PREFERRED AREAS OF USE ARE



Plant and Machine Engineering



HVAC



Utility vehicles / mobile hydraulics

TECHNICAL DATA

Input pressure range																
Nominal pressure gauge	[bar]	-1...0 ¹	1	1.6	2.5	4	6	10	16	25	40	60	100	160	250	400
Nominal pressure abs.	[bar]	-	1	1.6	2.5	4	6	10	16	25	40	60	100	160	250	400
Overpressure	[bar]	3	3	5	5	12	12	20	50	50	120	120	200	400	400	650
Burst pressure ≥	[bar]	4	4	7	7,5	15	18	30	70	75	150	180	300	500	750	1000
Vacuum resistance		unlimited														

¹ for this pressure range accuracy is ≤ 1 % span IEC 60770

Output signal / Supply	
Standard	2-wire: 4 ... 20 mA / V _S = 8 ... 32 V _{DC}
Options	3-wire: 0 ... 10 V / V _S = 14 ... 30 V _{DC}
	3-wire ratiometric: 10...90 % of V _S / V _S = 2.7...5 V _{DC}

Performance	
Accuracy ²	≤ ± 0.5 % span for P _N -1...0 bar: ≤ 1 % span
Permissible load	2-wire: R _{max} = [(V _S - V _{Smin}) / 0.02 A] Ω 3-wire: R _{min} = 10 kΩ
Influence effects	supply: 0.05 % span / 10 V load: 0.05 % span / kΩ
Response time	2-wire: ≤ 10 msec 3-wire: ≤ 3 msec
Long term stability	≤ ± 0.3 % span / year at reference conditions
Measuring rate	1 kHz

² accuracy according to EN IEC 62828-2- limit point adjustment (non-linearity, hysteresis, repeatability)

Thermal effects (Offset and Span) / Permissible temperatures	
Thermal error	≤ ± 0.3 % span / 10 K in compensated range: -25 ... 85 °C
Permissible temperatures	medium: -25 ... 125 °C electronics / environment: -25 ... 85 °C storage: -40 ... 85 °C

Electrical protection	
Short-circuit protection	permanent 3-wire ratiometric: none
Reverse polarity protection	no damage, but also no function
Electromagnetic protection	emission and immunity according to EN 61326

Mechanical stability	
Vibration	10 g, 25 Hz ... 2 kHz according to DIN EN 60068-2-6
Shock	500 g / 1 msec according to DIN EN 60068-2-27

Materials	
Pressure port / housing	stainless steel 1.4301 (304)
Seals (media wetted)	FKM others on request
Diaphragm	ceramics Al ₂ O ₃ 96 %
Media wetted parts	pressure port, seals, diaphragm



Pressure transmitters

Miscellaneous	
Option oxygen application	for P _N ≤ 15 bar: O-ring in 70 EPDM 281 (with BAM-approval); permissible maximum values are 15 bar / 60° C and 10 bar / 90° C for P _N ≤ 25 bar: O-ring in FKM Vi 567 (with BAM-approval); permissible maximum values are 25 bar / 150° C
Weight	approx. 120 g
Current consumption	2-wire: max. 25 mA 3-wire ratiometric: typ. 1.5 mA 3-wire voltage: max. 7 mA (short circuit current: max. 20 mA)
Operational life	100 million load cycles
CE-conformity	EMC Directive: 2014/30/EU Pressure Equipment Directive: 2014/68/EU (module A) ³

³ This directive is only valid for devices with maximum permissible overpressure > 200 bar

ELECTRICAL CONNECTION

Wiring diagrams

2-wire-system (current)

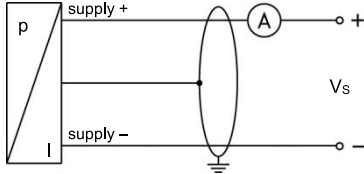

3-wire-system (voltage)

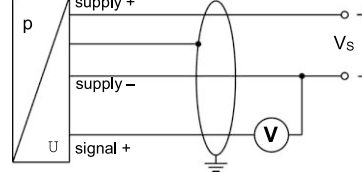

Pin configuration

Electrical connection	ISO 4400	Micro (contact distance 9.4 mm)	M12x1 (4-pin), metal	cable colours (IEC 60757)
Supply +	1	1	1	wh (white)
Supply -	2	2	2	bn (brown)
Signal + (for 3-wire)	3	3	3	gn (green)
Shield	ground pin	ground pin	4	gn/ye (green / yellow)

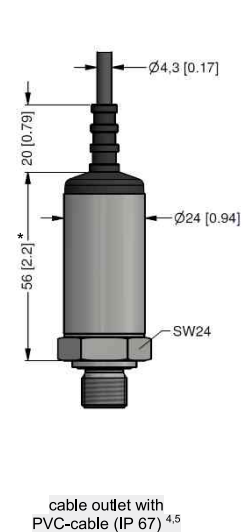
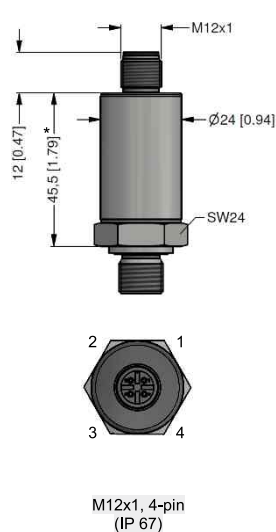
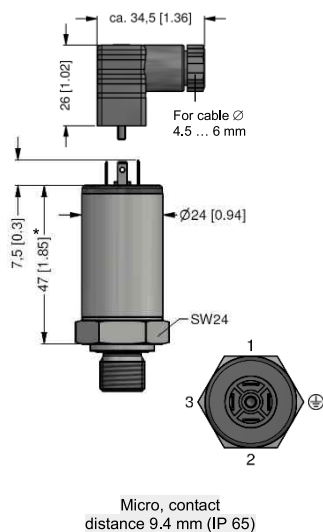
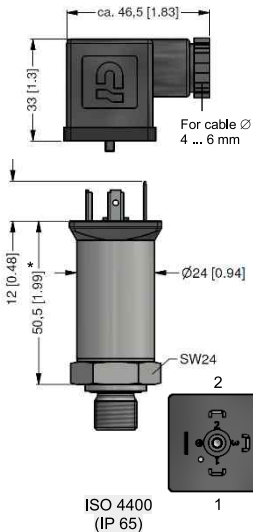

* pressure range P_N = 400 bar: total length increases by 12 mm.

⁴ standard: 2 m PVC cable without ventilation tube (permissible temperature: -5 ... 70°C)

⁵ different cable types and lengths available, permissible temperature depends on kind of cable

MECHANICAL CONNECTION

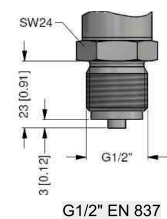
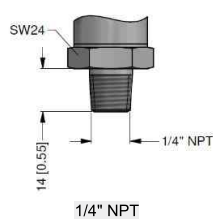
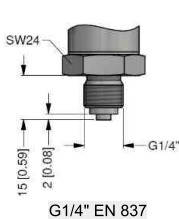
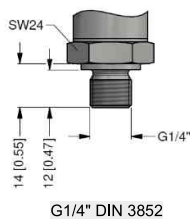

ORDER CODE

CCE-26.600G--------

Input [bar]									
0 ... 1	1	0	0	1					
0 ... 1,6	1	6	0	1					
0 ... 2,5	2	5	0	1					
0 ... 4	4	0	0	1					
0 ... 6	6	0	0	1					
0 ... 10	1	0	0	2					
0 ... 16	1	6	0	2					
0 ... 25	2	5	0	2					
0 ... 40	4	0	0	2					
0 ... 60	6	0	0	2					
0 ... 100	1	0	0	3					
0 ... 160	1	6	0	3					
0 ... 250	2	5	0	3					
0 ... 400	4	0	0	3					
-1 ... 0 (accuracy 1%)	X	1	0	2					
Customer	9	9	9	9					
Customer - underpressure (accuracy 1%)	X	X	X	X					
Pressure									
Gauge					R				
Absolute					A				
Output									
4 ... 20 mA / 2-wire					1				
0 ... 20 mA / 3-wire					2				
0 ... 10 V / 3-wire					3				
0 ... 5 V / 3-wire					4				
4 ... 20 mA / 3-wire					7				
1 ... 5 V / 3-wire					C				
10 ... 90 % Vs / 3-wire ratiometric (Vs = 2,7 ... 5 V DC)					R				
Customer					9				
Accuracy									
0,5 %					5				
1 % (underpressure ranges)					8				
0,5 % including Calibration Certificate					T				
1 % including Calibration Certificate					U				
Table of measured values for accuracy 0,5 %					N				
Customer					9				
Electrical connection									
Connector DIN 43650 (ISO 4400) (IP 65)					1	0	0		
Cable gland PG7 / cable length specify (IP 67)					4	0	0		
+ PVC cable / 1 m									
Connector DIN 43650 (ISO 4400) - potting compound inside (IP 67)					E	0	0		
Connector M12 x 1, 4-pin (IP 67)					M	0	0		
Connector M12 x 1, 4-pin (IP 67) - metal					M	1	0		
Cable outlet / cable length specify (IP 67) ¹					T	A	0		
+ PVC cable / 1 m									
Customer					9	9	9		



Pressure transmitters

CCE-26.600G- - - - - - -

Mechanical connection			
G 1/2" DIN 3852	1	0	0
G 1/2" EN 837	2	0	0
G 1/4" DIN 3852	3	0	0
G 1/4" EN 837	4	0	0
M 20 x 1,5 EN 837 (max. for 250 bar)	8	0	0
1/4" NPT	N	4	0
M 12 x 1,5 DIN 3852	C	0	0
G 1/2" DIN 3852 open	H	0	0
G 1/8" DIN 3852	Z	3	7
Customer	9	9	9
Seals			
Viton (FKM)			1
EPDM			3
Customer			9
Special version			
Standard			0 0 0
Oxygen application ($P_N \leq 25$ bar)			0 0 7
Oil and grease free			0 0 8
With throttle screw M4			0 7 0
Customer			9 9 9

1 - cable without through capillary (permissible temperature -5 ... +70°C)

Manufacturer reserves the right to change sensor specifications without further notice.

