



SWE-73-T

- ❑ low-cost meter in a small case
- ❑ input Pt100, Pt500, Pt1000
- ❑ automatic recognition of 2, 3 and 4-wires circuit connection
- ❑ RS-485 / Modbus RTU
- ❑ brightness adjustable in 8 steps
- ❑ signal peak value detection
- ❑ all parameters are freely programmable with remote controller or free configuration software S-Config

The low-cost **SWE-73-T** is a small, simple digital panel indicator, equipped with Pt 100/Pt 500/Pt 1000 type input, with automatic connection recognition (two, three or four wire sensor). The measurement range spans from -100°C to $+600^{\circ}\text{C}$, and input is fully linearised. Result is showed on 4-digit LED display. The 16-bit A/D converters used in them ensure very high stability and measurement precision. The RS-485 interface makes it easy to set up measurement networks in production process monitoring systems, and also to use the indicators as smart, programmable, digital converters of input signals for computer systems. The meter can be configured with IR remote controller or free S-Config software via the RS-485 communication port. Configuration of the device can also be programmed to the customer's order.

TECHNICAL DATA

| | |
|-----------------------------------|--|
| Power supply Power consumption | 110V AC $\pm 10\%$ separated, 230V AC $\pm 10\%$ separated or 24V DC (10V \div 30V DC) not separated from measurement input for 110V AC and 230V AC: max. 1,5 VA; for 24V DC: max. 1 W |
| Display | LED, red, 4 x 13 mm high, brightness adjustable in 8 steps |
| Input | temperature Pt100, Pt500, Pt1000, automatic recognition of 2, 3 and 4-conductor connection |
| Measuring range | $-100^{\circ}\text{C} \div 600^{\circ}\text{C}$ with resolution 0,1 $^{\circ}\text{C}$ |
| Accuracy | 0.1% @25 $^{\circ}\text{C} \pm$ one digit |
| Stability | 50 ppm/ $^{\circ}\text{C}$ |
| Communication interface | RS-485, 8N1 and 8N2, 1200 bit/s \div 115200 bit/s, Modbus RTU (not galvanically isolated) |
| Operating temp. | 0 $^{\circ}\text{C} \div +50^{\circ}\text{C}$ (standard), $-20^{\circ}\text{C} \div +50^{\circ}\text{C}$ (option) |
| Storage temp. | $-10^{\circ}\text{C} \div +70^{\circ}\text{C}$ (standard), $-20^{\circ}\text{C} \div +70^{\circ}\text{C}$ (depending on option) |
| Protection class | IP 65 (front side when an optional seal is installed); IP 40 (front side); IP 20 (case and connection clips) |
| Case | panel mounting; material: NORYL UL94V-0 |
| Dimensions | case (WxHxD): 72 x 36 x 77 mm (for 24V DC); 72 x 36 x 94 mm (for 110V AC and 230V AC) panel cut-out dimensions: 67 x 32,5 mm installation depth: min. 78 mm (for 24V DC); min. 95 mm (for 110V AC and 230V AC) board thickness: max. 5 mm |
| Weight | approx. 174 g |

DIMENSIONS

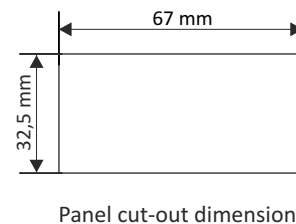
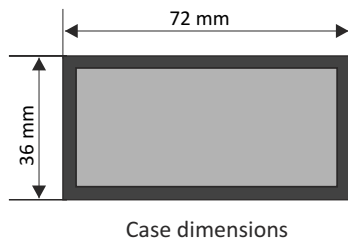
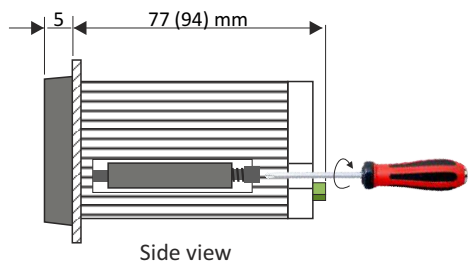

PIN ASSIGNMENTS

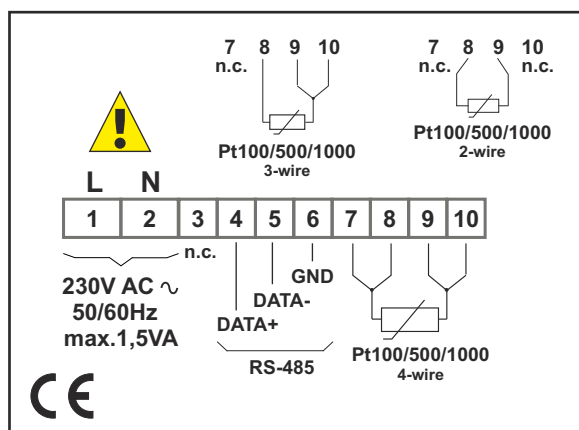

ORDERING

SWE-73-T-X-XX1-X

units:

0 : no unit on display
°C

options:

00 : no options
01 : IP 65 frame
08 : operating temp. -20°C ÷ +50°C
0P : IP 65 frame + operating temp. -20°C ÷ +50°C

power supply:

1 : 24V DC
2 : 230V AC
8 : 110V AC



MOUNTING PLATES

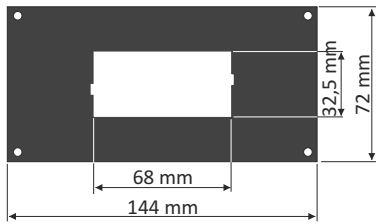

SMP-147/73
to mount 72 x 36 mm
size unit in place
of 144 x 72 mm cut-out

REMOTE CONTROLLER



SIR-15

InfraRed remote controllers may be used as external programming keyboard for all SIMEX devices equipped with IR receivers and remote programming functions. Pressing of any local IR controller key, causes transmission of its code to the device. Functions of particular keys depend on devices features.

Power supply voltage: 6V DC - 4 alkaline batteries type LR44
Operation range: from 0,5 to 5 m (depend on programmed device features)

SOFTWARE

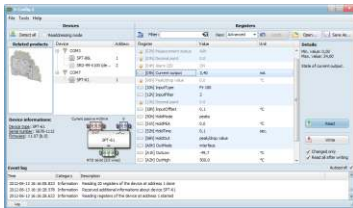

S-Config 2 is used for the simultaneous detection of devices in multiple Modbus RTU networks and allows user to change the configuration of most of them. For each detected device a list of its registers, which the user can modify, is displayed and also additional informations about device parameters (type, address in the network, etc.).

S-Config software can be downloaded from SIMEX website at www.simex.pl

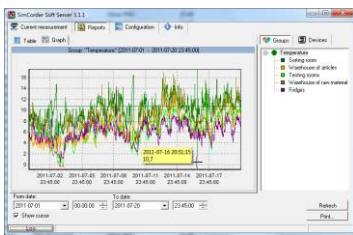

SimCorder Soft is a visualisation application created to facilitate work with advanced networks of the SIMEX devices, for acquisition, visualisation, reporting, archiving, exporting and printing of measurement data from all network devices. You can download measurements from the devices automatically or on demand. There is a possibility of immediate notification about emergency states via SMS or e-mail, which will often allow to quickly resolve an arising problem while avoiding long and expensive stoppages. You can view the measurement data, emergency states and configuration via the internet at every time.

CONVERTERS



The **SRS-U4** module is designed to connect a USB host to slave devices equipped with RS-485 interface. The PC with special software can be used as a host. The **SRS-U4** unit guarantees full galvanic isolation between USB and RS-485 circuits. The converter can work with any devices equipped with RS-485 interface and contains integrated circuit which supports USB 1.1 and USB 2.0 standards. The main purpose is connection of PC host computer with industrial data acquisition and visualisation systems based on RS-485 interface.

The **SRS-U4** can be also manufactured with DIN mounting adaptor.