

R5020 Lite

Hardware Manual



Version: 1.0.1

Date: Feb. 27, 2023

Regulatory and Type Approval Information

Table 1: Toxic or Hazardous Substances or Elements with Defined Concentration Limits

Name of the Part	Hazardous Substances									
	(Pb)	(Hg)	(Cd)	(Cr(VI))	(PBB)	(PBDE)	(DEHP)	(BBP)	(DBP)	(DIBP)
Metal parts	o	o	o	o	-	-	-	-	-	-
Circuit modules	o	o	o	o	o	o	o	o	o	o
Cables and cable assemblies	o	o	o	o	o	o	o	o	o	o
Plastic and polymeric parts	o	o	o	o	o	o	o	o	o	o

o:
Indicates that this toxic or hazardous substance contained in all of the homogeneous materials for this part is below the limit requirement in RoHS2.0.

X:
Indicates that this toxic or hazardous substance contained in at least one of the homogeneous materials for this part *might exceed* the limit requirement in RoHS2.0.

-:
Indicates that it does not contain the toxic or hazardous substance.

Radio Specifications for Europe

RF technologies	3G, 4G, 5G, Wi-Fi
Cellular Frequency*	5G: NR SA/NSA: n1/n2/n3/n5/n7/n8/n12/n13/n14/n18/n20/n25/n26/n28/n29/n30/n38/n40/n41/n48/n66/ n71/n75/n76/n77/n78/n79 4G: LTE FDD: B1/B2/B3/B4/B5/B7/B8/B12/B13/B14/B17/B18/B19/B20/B25/B26/B28/B29/B30/B32/B66/B71 LTE TDD: B34/B38/B39/B40/B41/B42/B43/B48 LAA: B46 (only supports 2 x 2 MIMO) 3G: WCDMA: B1/B2/B4/B5/B8/B19
Wi-Fi Frequency	2.4 GHz: 2.412 - 2.472 GHz 5 GHz: 5.150 - 5.825 GHz
Max RF power	23 dBm ± 2dB@NR, 23 dBm ± 2dB@LTE, 23 dBm ± 2dB@WCDMA, 18 dBm ± 2dB@Wi-Fi

* *May vary on difference models.*

Note: Operation of 5150 ~ 5250 MHz frequency range is restricted to indoor use only.

Caution: The user is cautioned that changes or modifications not expressly approved by the party responsible for compliance could void the user's authority to operate the equipment.

This device contains licence-exempt transmitter(s)/receiver(s) that comply with Innovation, Science and Economic Development Canada's licence-exempt RSS(s) and Part 15 of the FCC Rules. Operation is subject to the following two conditions:

- (1) This device may not cause interference.
- (2) This device must accept any interference, including interference that may cause undesired operation of the device.

L'émetteur/récepteur exempt de licence contenu dans le présent appareil est conforme aux CNR d'Innovation, Sciences et Développement économique Canada applicables aux appareils radio exempts de licence. L'exploitation est autorisée aux deux conditions suivantes :

- (1) L'appareil ne doit pas produire de brouillage;
- (2) L'appareil doit accepter tout brouillage radioélectrique subi, même si le brouillage est susceptible d'en compromettre le fonctionnement.

Note: This equipment has been tested and found to comply with the limits for a Class B digital device, pursuant to Part 15 of the FCC Rules. These limits are designed to provide reasonable protection against harmful interference in a residential installation. This equipment generates, uses and can radiate radio frequency energy and, if not installed and used in accordance with the instructions, may cause harmful interference to radio communications. However, there is no guarantee that interference will not occur in a particular installation.

If this equipment does cause harmful interference to radio or television reception, which can be determined by turning the equipment off and on, the user is encouraged to try to correct the interference by one or more of the following measures:

- Reorient or relocate the receiving antenna.
- Increase the separation between the equipment and receiver.
- Connect the equipment into an outlet on a circuit different from that to which the receiver is connected.
- Consult the dealer or an experienced radio/TV technician for help.

FCC& IC Radiation Exposure Statement

This equipment complies with FCC and Canada radiation exposure limits set forth for an uncontrolled environment. This equipment should be installed and operated with a minimum distance of 20cm between the radiator and your body.

This transmitter must not be co-located or operating in conjunction with any other antenna or transmitter.

Déclaration d'IC sur l'exposition aux radiations

Cet équipement est conforme aux limites d'exposition aux radiations définies par le Canada pour des environnements non contrôlés. Cet équipement doit être installé et utilisé à une distance minimum de 20 cm entre l'antenne et votre corps.

Cet émetteur ne doit pas être installé au même endroit ni utilisé avec une autre antenne ou un autre émetteur.

Simplified EU Declaration of Conformity

We, Guangzhou Robustel Co., Ltd. are located at 501, Building #2, 63 Yongan Road, Huangpu District, Guangzhou, China, declare that this radio equipment complies with all applicable EU directives. The full text of the EU DoC is available at the following internet address:

www.robustel.com/certifications/

Safety Information

General

- The router generates radio frequency (RF) power. When using the router, care must be taken on safety issues related to RF interference as well as regulations of RF equipment.
- Do not use your router in aircraft, hospitals, petrol stations or in places where using cellular products is prohibited.
- Be sure that the router will not be interfering with nearby equipment. For example: pacemakers or medical equipment. The antenna of the router should be away from computers, office equipment, home appliance, etc.
- An external antenna must be connected to the router for proper operation. Only uses approved antenna with the router. Please contact authorized distributor on finding an approved antenna.

RF Exposure

- This device meets the official requirements for exposure to radio waves. This device is designed and manufactured not to exceed the emission limits for exposure to radio frequency (RF) energy set by authorized agencies.
- The device must be used with a minimum separation of 20 cm from a person's body to ensure compliance with RF exposure guidelines. Failure to observe these instructions could result in your RF exposure exceeding the applicable limits.

Note: Some airlines may permit the use of cellular phones while the aircraft is on the ground and the door is open. Router may be used at this time.



The symbol indicates that the product should not be mixed with general household waste but must be sent to separate collection facilities for recovery and recycling.



The symbol indicates that the product meets the requirements of the applicable EU directives.



The symbol indicates that the product meets the requirements of the relevant UK legislation.

Related download link

Find more product documents or tools at:

www.robustel.com/en/documentations/

Technical Support

Tel: +86-20-82321505

Email: support@robustel.comWeb: www.robustel.com**Document History**

Updates between document versions are cumulative. Therefore, the latest document version contains all updates made to previous versions.







Date	Firmware Version	Document Version	Change Description
Nov. 23, 2022	5.0.0	1.0.0	Initial release.
Feb 27, 2023	5.0.0	1.0.1	Optimized image display of mounting kit.

Overview

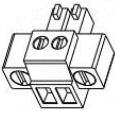
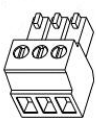
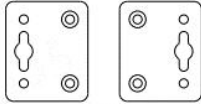
The R5020 Lite is Robustel’s new 5G capable router supporting global 5G, 4G and 3G bands. The R5020 Lite leverages our tried and tested high performance CPU platform and it is compatible with 3GPP Release 16.

Package Checklist

Before commencing installation ensure your package has the following components:

<p>Device</p> 	<p>2-PIN Terminal Block</p> 	<p>3-PIN Terminal Block</p> 	<p>Mounting Kit</p> 	<p>RCMS Card</p> 
<p>Quick Start Guide Card</p> 	<p>Power Supply (Optional)</p> 	<p>Cellular Antenna (Optional)</p> 	<p>Wi-Fi Antenna (Optional)</p> 	

Note: The accessories could be different on specific order.

Panel Layout (May Vary on Different Models)

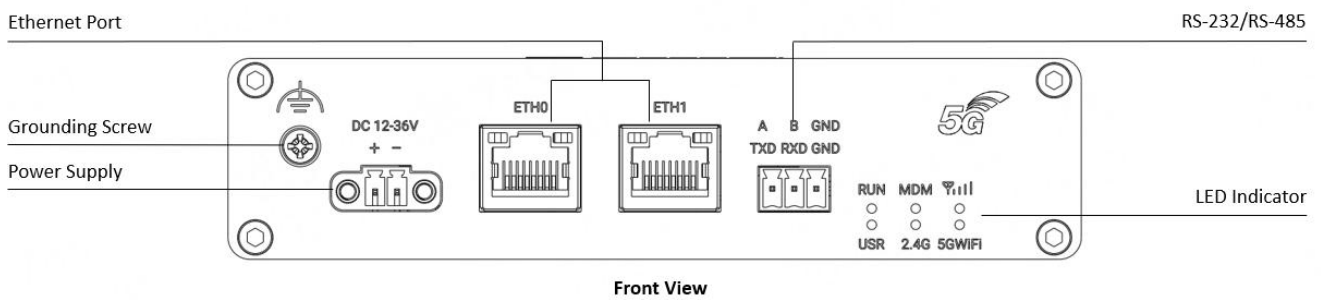

Front View

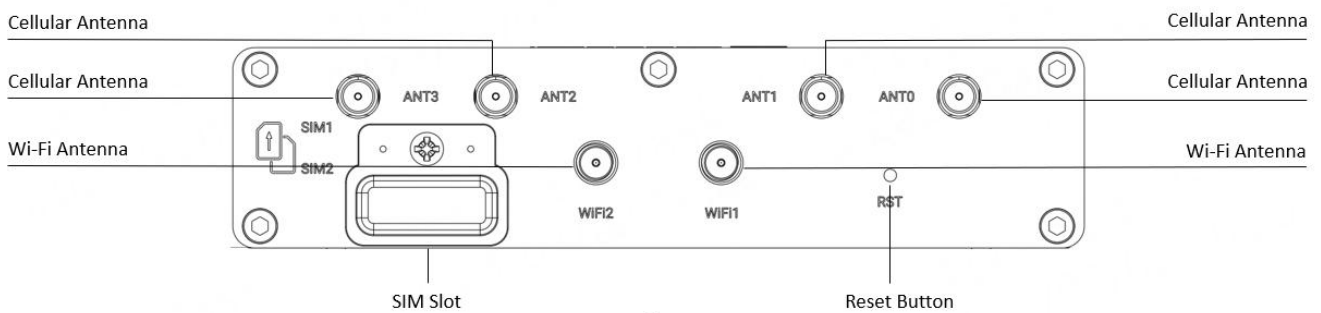

Back View

Interface Descriptions

1. LED Indicator

Name		Color	Status	Description
RUN		Green	Fast Blinking (250ms)	Router is preparing (system initialization)
			On, blinking (500ms)	Router starts operating
			Off	Router is powered off
MDM		Green	On, solid	Link connection is working
			On, blinking	Data is sent and received
			Off	Link connection is not working
USR	USR-OpenVPN	Green	On, solid	OpenVPN connection is established
			Off	OpenVPN connection is not established
	USR-IPsec	Green	On, solid	IPsec connection is established
			Off	IPsec connection is not established
	USR-SIM	Green	On, solid	Using primary SIM card 1
			On, blinking	Using backup SIM card 2
Off			Using WAN link (no SIM card inserted)	
RSSI		Green	On, solid	5G network: Reference Signal Received Power greater than -86 dBm (Strong signal) Non-5G network: Received Signal Strength Indication greater than -73 dBm (Strong signal)
			On, blinking (1s)	5G network: Reference Signal Received Power -105 to -86 dBm (Moderate signal) Non-5G network: Received Signal Strength Indication -91 to -73 dBm (Moderate signal)
			Fast blinking	5G network: Reference Signal Received Power -140 to -106 dBm (Weak signal) Non-5G network: Received Signal Strength Indication -111 to -93dBm (Weak signal)
		--	Off	No signal
2.4G		Green	On, solid	2.4 GHz Wi-Fi is enabled and working properly
			On, blinking	2.4 GHz Wi-Fi is working normally and there is data sending and receiving
			Off	2.4 GHz Wi-Fi is disabled or not working properly
5G Wi-Fi		Green	On, solid	5 GHz Wi-Fi is enabled and working properly
			On, blinking	5 GHz Wi-Fi is working normally and there is data sending and receiving
			Off	5 GHz Wi-Fi is disabled or not working properly

Note: You can choose the display type of USR LED. For more details, please refer to

RT123_SM_RobustOS Software Manual, Services > Advanced > System > System Settings > User LED Type.

2. PIN Description

PIN	Description	Note
1	V+	Power Supply Positive
2	V-	Power Supply Negative
3	TXD/A	RS232 Data Transmission/RS485_A, may vary on different model.
4	RXD/B	RS232 Data Receive/RS485_B, may vary on different model.
5	GND	Signal Ground

Note:
1) The input voltage is 12 to 36V DC.

3. Reset Button

Feature	Operation
Reboot	Press and hold the RST button for 2~5 seconds under the operating status.
Restore to default configuration	Press and hold the RST button for 5~10 seconds, the RUN LED starts blinking quickly, the router will restore to default configuration.
Restore to factory default settings	Once the operation of restoring default configuration is performed twice within one minute, the router will restore to factory default settings.

Note: The more details please refer to *RT123_SM_RobustOS Software Manual, 2.3 Factory Reset*.

4. Ethernet Ports. There are two Ethernet ports on R5020 Lite, including ETH0, ETH1. The ETH0 on the router can be configured as a WAN port, while ETH1 can only be configured as a LAN port. By default, ETH0, ETH1 are lan0, and their IP are 192.168.0.1/255.255.255.0.

Ethernet LED Indicator	Status	Description
Link indicator (Yellow)	On, solid	Connection is established
	On, blinking	Data is being transferred
	Off	Connection is not established

Hardware Installation

1. **SIM Card Installation.** Remove the SIM card cover to insert the SIM cards into the device, then screw up the cover.

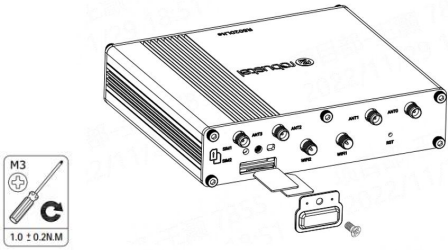

2. **Antenna Installation.** Rotate the antenna into the antenna connector accordingly.

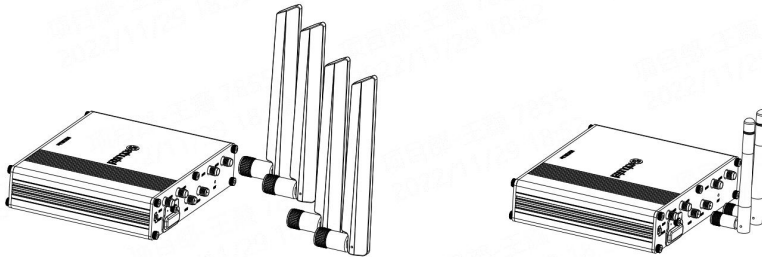

3. **Terminal Block Installation.** Insert the 3-PIN terminal blocks into the interfaces connector, then can connect the devices or sensors to the gateway via corresponding interfaces.

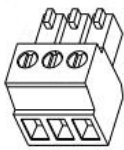

4. **Mounting Kit Installation.**

- DIN Rail Mounting

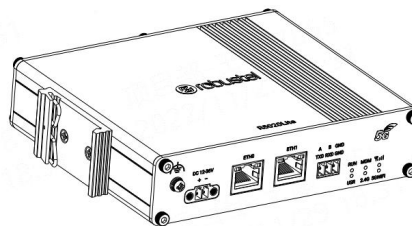

- Wall Mounting

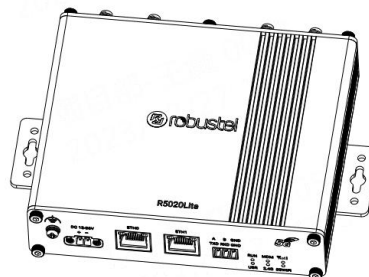

5. Grounding the Device. Grounding will help to prevent the noise effect due to electromagnetic interference (EMI). Connect the device to the site ground wire by the grounding screw before powering on.

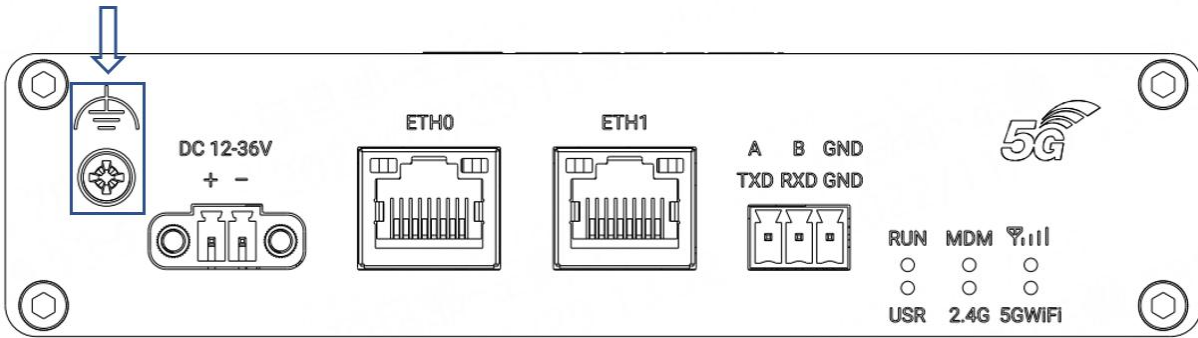

6. Connect the router to the computer. Connect the Ethernet cable to any port labeled ETH0 or ETH1 of the router, and connect the other end of the cable to your computer.

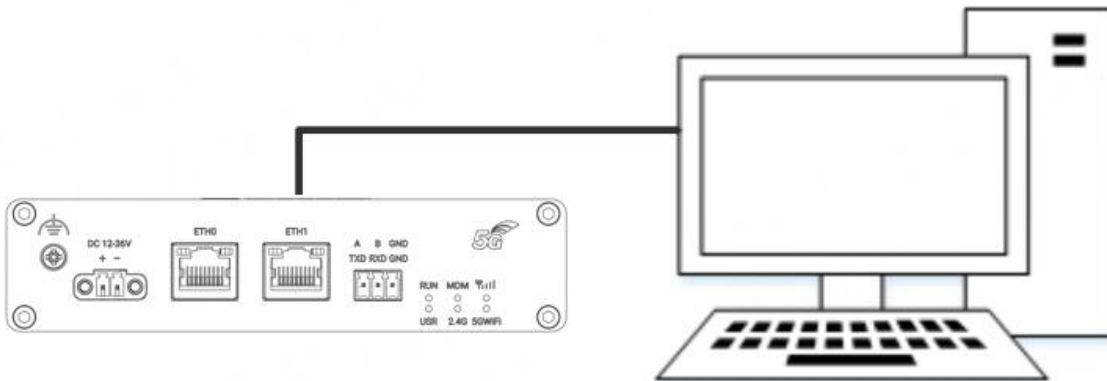

Login to the Device

1. Connect the router’s Ethernet port to a PC with a standard Ethernet cable.
2. Before logging in, manually configure the PC with a static IP address on the same subnet as the gateway address, click and configure "Use the following IP address".

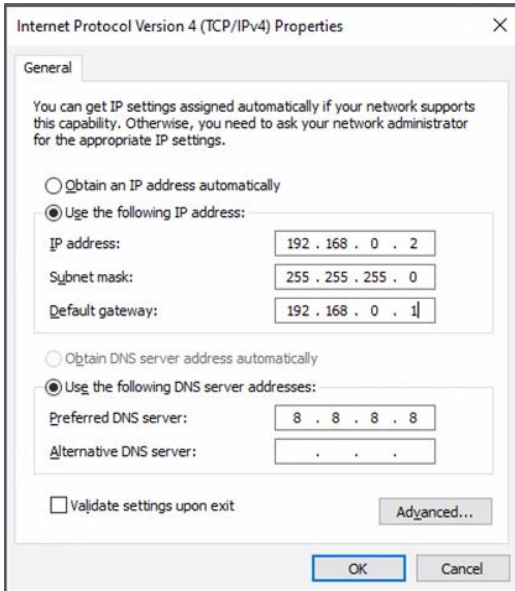

3. To enter the gateway's web interface, type <http://192.168.0.1> into the URL field of your Internet browser.
4. Use login information shown in the product label when prompted for authentication.



5. After logging in, the home page of the web interface is displayed, then you can view system information and perform configuration on the device.

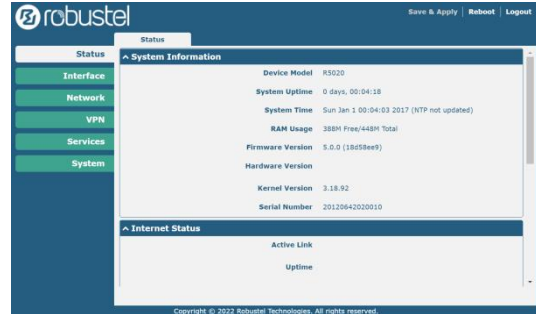

6. The automatic APN selection is ON by default, if need to specify your own APN, please go to the menu **Interface->Link Manager->Link Setting->WWAN Settings** to finish the specific setting.

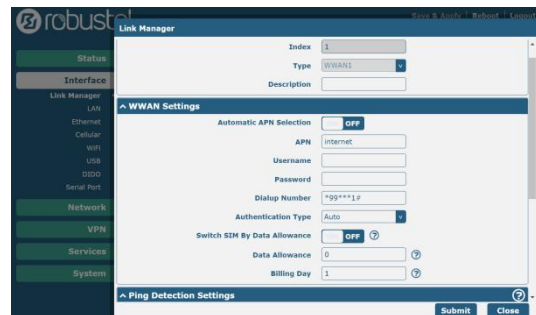

7. The more configuration details please refer to **RT123_SM_RobustOS Software Manual**.
(END)