



Instruction manual

M1140

M1200

M1220

M1300

M1320

M1321

M1322

M1323

M1440

Multilogger

© Copyright: COMET SYSTEM, s.r.o.

It is prohibited to copy and make any changes in this manual, without explicit agreement of company COMET SYSTEM, s.r.o. All rights reserved.

COMET SYSTEM, s.r.o. makes constant development and improvement of their products. Manufacturer reserves the right to make technical changes to the device without previous notice. Misprints reserved.

Contact the manufacturer of this device:

COMET SYSTEM, s.r.o.
Bezrucova 2901
756 61 Roznov pod Radhostem
Czech Republic
www.cometsystem.com

Content

INTRODUCTION.....	4
GENERAL SAFETY PRECAUTIONS	6
GETTING STARTED.....	7
Multilogger in portable application	7
Multilogger in stationary application	8
INSTALLATION INSTRUCTION.....	9
Recommendations for mounting	12
INPUTS OF MULTILLOGGER	15
Input connectors	16
ALARM OUTPUT	20
POWER SUPPLY OF MULTILLOGGER	22
KEYBOARD OPERATION.....	25
Control and indication parts	25
Basic display operation	26
Main menu	28
CONNECTING WITH THE COMPUTER	32
SOFTWARE COMET VISION	33
DEVICE SETUP USING SOFTWARE	35
Device configuration basics	35
Device configuration items	35
APPLICATIONS NOTES	45
OPERATION AND MAINTENANCE RECOMMENDATIONS.....	51
TECHNICAL PARAMETERS.....	54
Power supply	54
ALARM OUT output	56
Communication interfaces.....	57
Measuring, data memory and real time clock	58
Electromagnetic compatibility.....	58
Operation and storage conditions	59
Mechanical characteristics	59
Technical parameters of the inputs	60
APPENDIXES	71
Appendix 1: Selected error messages.....	71
Appendix 2: Output and power supply circuits.....	73
Appendix 3: Input circuits	74
Appendix 4: Connecting of Pt1000 RTD probe.....	75

Introduction

The Multilogger has been designed for measuring and recording physical and electric quantities with an adjustable logging interval from 1 second to 24 hours. The device is equipped with 4 inputs (connectors) for external probes or signals. Moreover, some versions also include an internal atmospheric pressure and/or CO₂ concentration sensor. The production line consists of several models with various combinations of the input ranges of the measured quantities. The Multilogger can be used either as stationary or portable device.

The device allows for:

- Measuring and processing input quantities; the maximum number of the measured and calculated quantities is 16. Some models can also acquire data from binary inputs (up to 2 inputs). Models for measuring barometric pressure allow sea level recalculation.
- Finding and storing minimal and maximal values for each measured quantity (since their last manual reset).
- Acquiring autonomous time record of measured values, independent of the mains supply. Recorded values can be stored as separate samples in the recording time or as average/ minimal/maximal values during the logging interval. Recording may be continuous, or only during an alarm optionally.
- Creating alarm states and perform actions (audio and optical signalization, alarm output signal, report messages via telephone dialer and/or various Ethernet interface protocols, etc.).
- On-line monitoring of the measured values and states. Accessing these values via the web.
- Collecting and processing data in the central database.
- Powering by batteries (NiMH accumulators or alkaline batteries).
- Powering by external power supply, which can be also used for charging NiMH accumulators. External power supply is required for full operation of the Ethernet interface. Some limited functions of this interface may be available during battery operation.

Multilogger drawing:

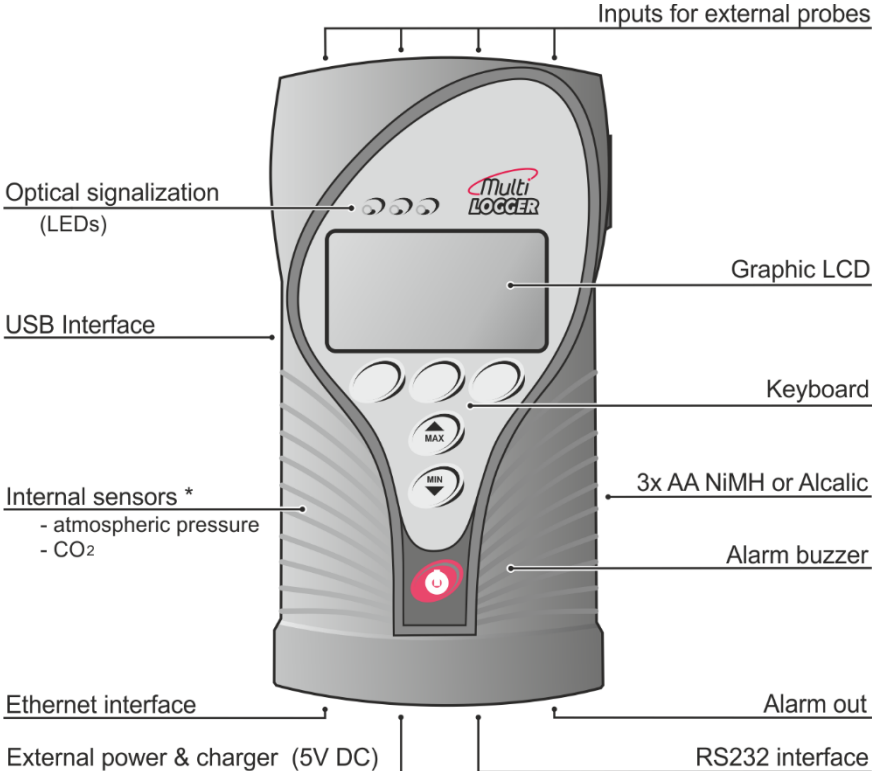

* only certain models

General safety precautions



The following list of precautions serves to reduce risk of injury or damage of described instrument. To prevent injuries use instrument accordingly with rules in this manual.

- **Installation and service need to be performed by qualified persons only.**
- **Use** a suitable power supply. Use power supplies only with a voltage recommended by the manufacturer (+5V DC) and approved in accordance with proper standards. Pay attention, the source has undamaged cables or cover.
- **The device** and power supply must not be used in a humid and hazardous environment (such as bathrooms), at locations exposed to direct sunlight and to other heat sources, thus preventing damages and deformation of the cover.
- **Do not use the instrument without its covers.** Do not remove the covers from the device.
- **Do not use** the instrument if it does not work correctly. If you think, that the device is not working correctly, let check it by qualified service person.
- **Never** charge batteries that are not rechargeable.
- Do not use **the device in explosive environment.**

Getting started

Multilogger in portable application

- **Connect the appropriate probes and signals to the device** - for the DigiS/M, DigiL/M and Pt1000/M probes, follow the optical key for correct orientation of the connector. Probes of the DigiL/M-xx line with a cable can be placed in the holder on the side of device (optional accessory). For more information, see Chapter *"INPUTS OF MULTILOGGER"*.
- **Switch on the Multilogger** - push the switch button on the device. The display lights and the instrument starts working. If you will communicate with PC via the Ethernet interface, the power adapter +5V DC is necessary (supplied accessories). For more information, see Chapter *"POWER SUPPLY OF MULTILOGGER"*.
- **Install Comet Vision software to your computer** - it is available at www.cometsystem.com. If you purchased a license for full version, register it.
- **Connect Multilogger with your PC** - you can use the USB, Ethernet or RS232 port (special cable necessary). The external power supply is needed for Ethernet interface communication. For more information, see Chapter *"CONNECTING WITH THE COMPUTER"*.
- **Device settings** - use SW to set up the device in accordance with the connected probes and your requirements. If you are not going to use the device soon, turn it off and place it in its transportation case. For more information, see Chapter *"DEVICE SETUP USING SOFTWARE"*.
- **Measurements** - remove the Multilogger from the transportation case, connect probes and external power adapter (if needed) and turn the device on. Some device settings can be changed from its keyboard. When measurement ends, move the device to your computer room and download the recorded data to PC. For more information, see Chapter *"KEYBOARD OPERATION"*.
- **Charging batteries** - if the Multilogger includes rechargeable batteries, you can recharge them when needed. For more information, see also Chapter *"POWER SUPPLY OF MULTILOGGER"*.
- **Maintenance and periodic inspections** - In order to secure reliable operation of the device, it is recommended to make regular inspections. For more information, see part *"OPERATION AND MAINTENANCE RECOMMENDATIONS"*.

Multilogger in stationary application

- **Select a suitable location for placing of the Multilogger** - pay attention to parameters of ambient environment, minimize the number of cables, avoid sources of interferences. For more information, see Chapter *“INSTALLATION INSTRUCTIONS”*.
- **Mounting of sensors and routing of cables** - pay attention to rules of theirs installation, use recommended working positions, keep enough distance from high power devices and cables.
- **Connect the appropriate probes and signals to the device** - for the DigiS/M, DigiL/M and Pt1000/M probes, follow the optical key for correct orientation of the connector. Probes of the DigiL/M-xx line with a cable can be placed in the holder on the side of device (optional accessory). For more information, see Chapter *“INPUTS OF MULTILOGGER”*.
- **Check proper connection** - before first switching on. If Multilogger controls other action regulation elements, it is recommended to put them out of operation before configuration of Multilogger.
- **Switch on the Multilogger** - push the switch button on the device. The display lights and the instrument starts working. If you will communicate with PC via the Ethernet interface, the power adapter +5V DC is necessary (supplied accessories). For more information, see Chapter *“POWER SUPPLY OF MULTILOGGER”*.
- **Install the *COMET Vision* software to your computer** - it is available at www.cometsystem.com. If you purchased a license for the extended SW, register it.
- **Connect Multilogger with your PC** - you can use the USB, Ethernet or RS232 port (special cable necessary). For Ethernet interface communication the external power supply is needed. For more information, see Chapter *“CONNECTING WITH THE COMPUTER”*.
- **Device settings** - use *COMET Vision* software to set up the device in accordance with the connected probes and your requirements. If needed, check the alarms functionality. For more information, see Chapter *“DEVICE SETUP USING SOFTWARE”*.
- **Maintenance and periodic inspections** - In order to secure reliable operation of the device, it is recommended to make regular checks. For more information, see part *“OPERATION AND MAINTENANCE RECOMMENDATIONS”*.

Installation instruction

Location of Multilogger must match the operating conditions and not allowed manipulations.

Working position of the device:

- Multilogger placed on a horizontal, nonflammable surface (*horizontal working position is not suitable for devices with thermocouple inputs and for devices with cable-less probes*).
- Multilogger fixed on the wall from nonflammable materials or in a low-current switchboard using the holder - the working position is with input connectors upwards.

Device dimensions:

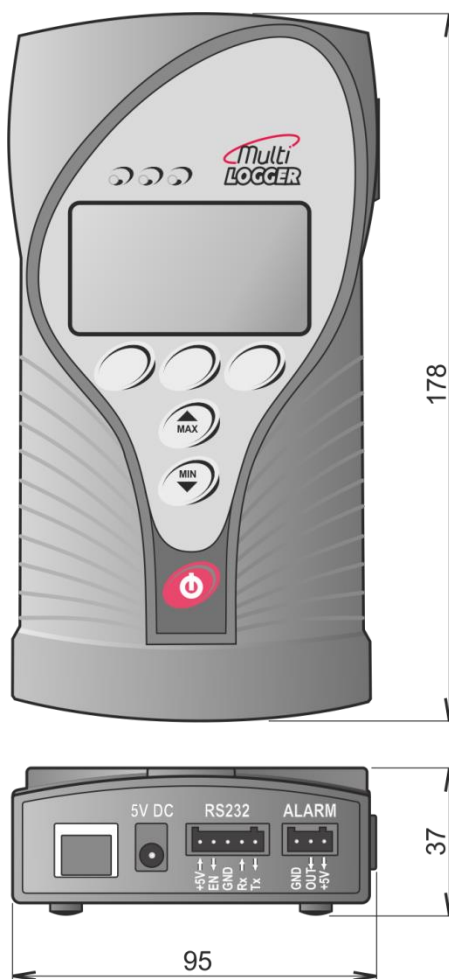

The way of mounting the holder to Multilogger and mounting holes dimensions:

MLP001

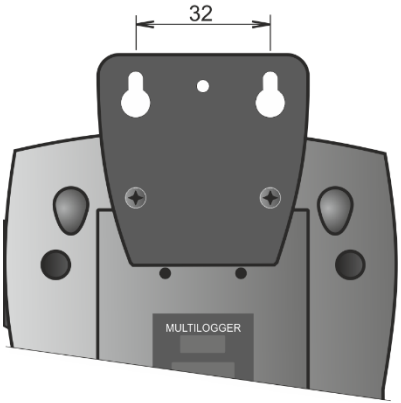

MLP002

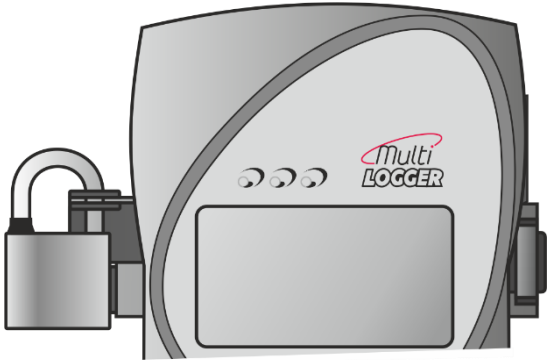
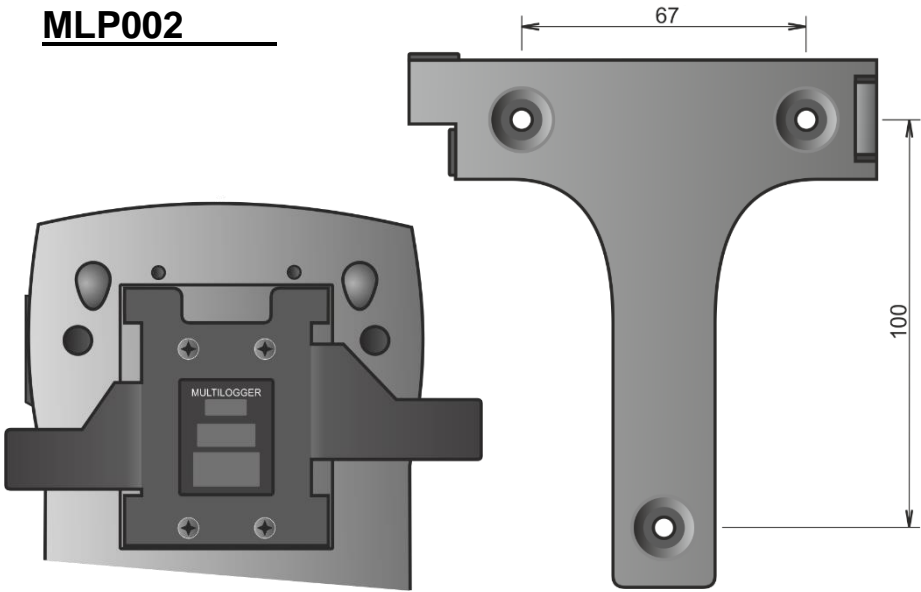

MLP004

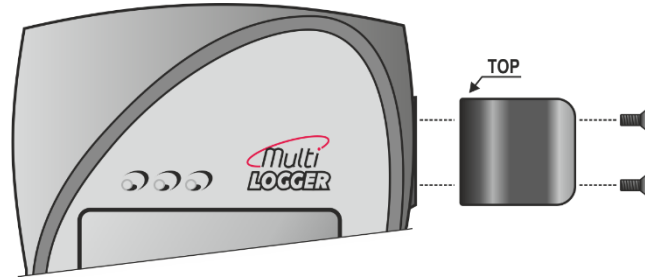

Recommendations for mounting

- **Do not mount Multilogger near sources of interference** (Multilogger must not be mounted directly to power switchboard nor to its nearness. Also do not mount data logger near power contactors, motors, frequency converters and other sources of strong interference).

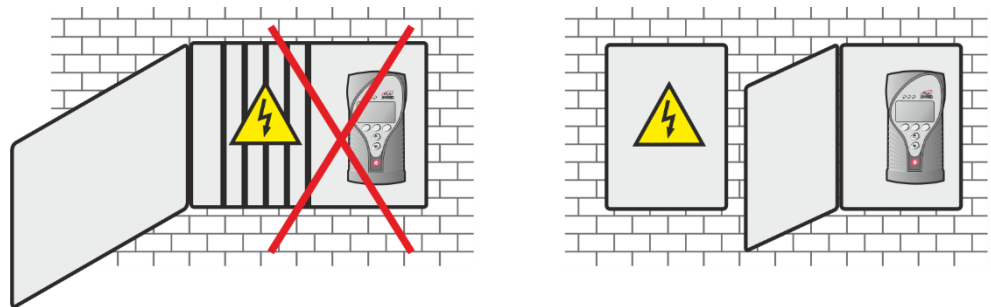

- **In cable routing** follow rules of standards for installation of low current distribution (EN 50174-2), especially it is necessary to pay attention to avoid electromagnetic interference intrusion to the leads, transmitters, transducers and sensors. Do not locate cabling near sources of interference.
- **Do not use leads in parallel with power distribution network leads**

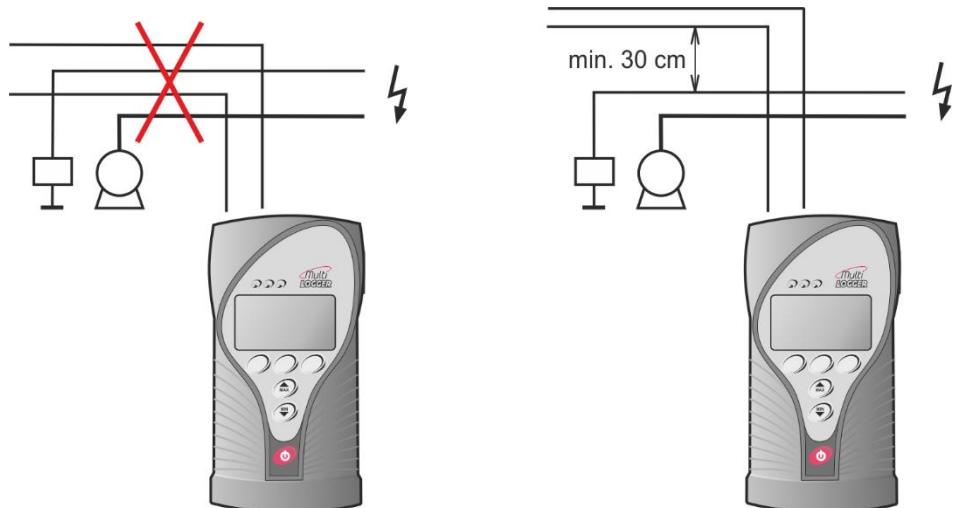

-
- **Do not use cables longer than 30 m generally;** for RTD sensors is recommended max. 15 m; cables must be installed only in interior areas.

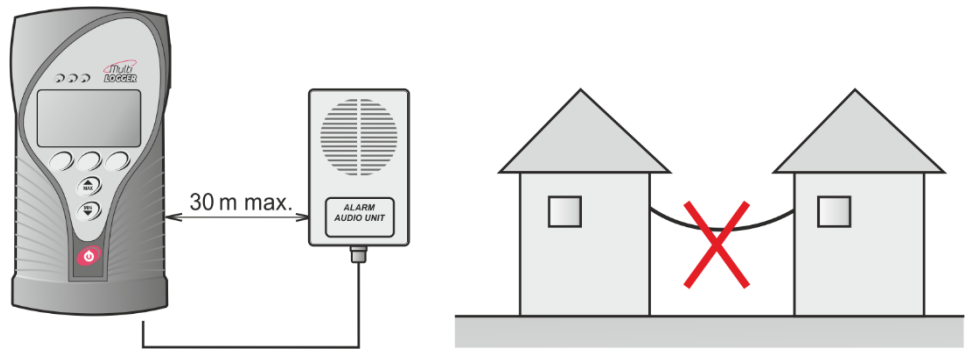

- **Do not interconnect the inputs with other measuring systems.**

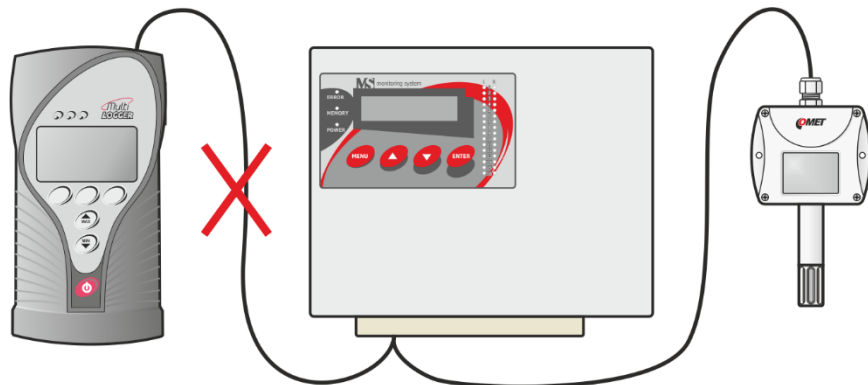

- **Use shielded cables for the voltage and current inputs** - connect the shielding to the Multilogger but not to the end devices if these do not have a special terminal for it. In this case, shielding must not be connected to external metal parts of this device or to any other device. Never use shielding as a signal wire.

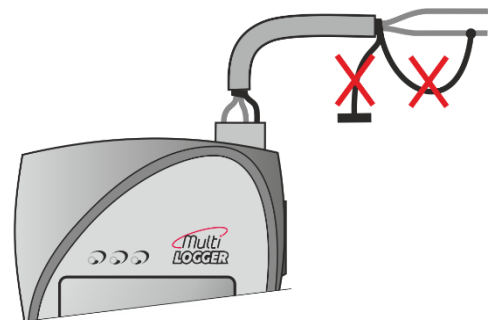

-
- **Do not use common leads for several inputs.**
 - **It is recommended to earth larger systems with Multilogger at one point** - the GND terminal of the alarm output can be used for this purpose. This grounding will work correctly if the system would not be grounded currently at another point too. One-point grounded systems are more resistant against electromagnetic disturbance.

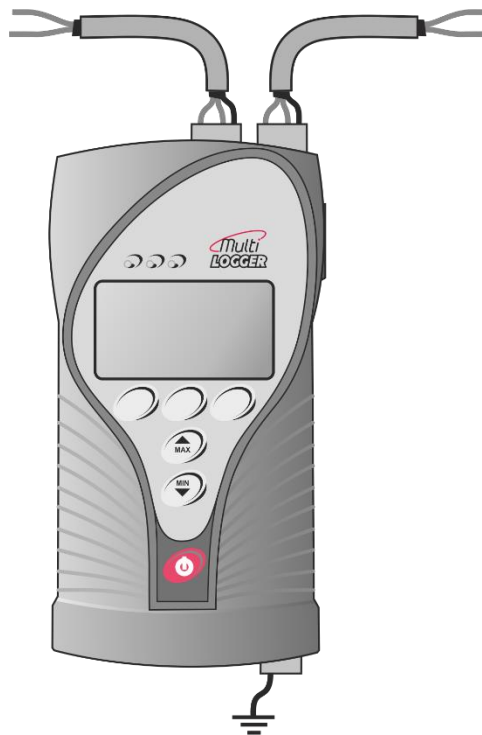

Inputs of Multilogger

Manufactured models differ from each other by their input ranges and by input connectors. Prior to connecting voltage and current input signals, you should check their parameters in the following part: “*TECHNICAL PARAMETERS OF THE MULTILOGGER INPUTS*”.

Universal input with MiniDIN connector



- temperature and humidity probe of Digi/M line
- temperature probe of Pt1000/M line
- temperature probe Pt1000 (custom RTD)

Universal input with miniature thermocouple connector

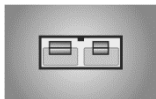

- thermocouples of the K, J, S, B, T and N types
- DC Voltage - 18 mV to +18 mV
- DC Voltage - 60 mV to +140 mV

Universal input with terminals

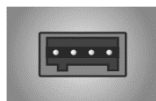

- DC current 0 to 20 mA
- DC voltage 0 to 10 V
- binary signals

M1140

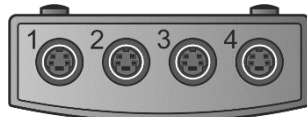

M1200

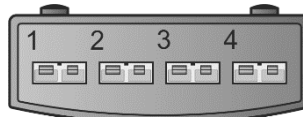

M1220

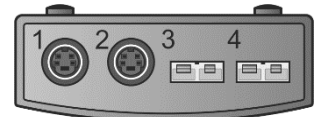

M1300

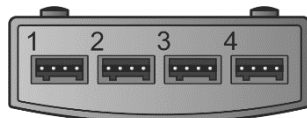

M1320

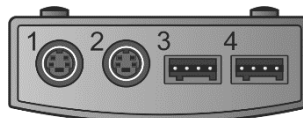

M1321

p

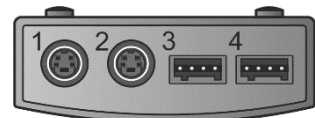

M1322

CO₂

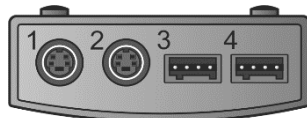

M1323

p CO₂

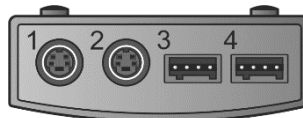

M1440

IN1-CO₂

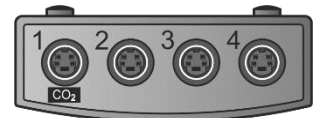

p

Barometric pressure internal sensor

CO₂

CO₂ concentration internal sensor

IN1-CO₂

CO₂ external probe only

Input connectors



The Multilogger does not have galvanically isolated inputs. For this reason, only devices that are not connected to any other circuit may be connected to the inputs of Multilogger. Simplified circuit diagram of inputs is shown in *Appendix 3*.

MiniDIN connector

It is used for connecting the DigiS/M..., DigiL/M..., Pt1000/M probes and for external CO₂ probe. Plug properly oriented probe connector to the input of Multilogger. You can follow the optical key for correct position. Make sure that the wires, including their shielding, are not connected to any other conductive parts! Universal MiniDin connectors are designed for DigiS/M..., DigiL/M... or Pt1000/M probes. Conventional (custom) probes with a Pt1000 sensor can also be connected, however with certain limitations (see *Appendix 4*). The input connector marked "CO₂" is not universal and it is designed for external CO₂ probe only.

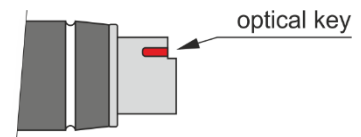

Universal thermocouple connector

Plug properly oriented connector to the input of Multilogger. The connector is mechanically coded using a wider pin. Use the white uncompensated connector for measuring voltage. Make sure that the wires are not connected to any other conductive parts! Electrical coupling among thermocouples can cause large measurement errors or instable values! To obtain correct measurement values, the Multilogger has to be temperature-stabilized!

Marking of subminiature thermocouple connectors and wires manufactured by OMEGA (in accordance with US standard):

Thermocouple type	Connector color	+ wire color	- wire color
K (NiCr-Ni)	Yellow	Yellow	Red
J (Fe-Co)	Black	White	Red
S (Pt10%Rh-Pt)	Green	Black	Red
B (Pt30%Rh-Pt)	White	Black	Red
T (Cu-CuNi)	Blue	Blue	Red
N (NiCrSi-NiSiMg)	Orange	Orange	Red

Two voltage ranges are available on each universal thermocouple connector for measuring small voltages:

- range -60 mV to +140 mV
- range -18 mV to +18 mV

Use the white uncompensated connector connected according to the picture.

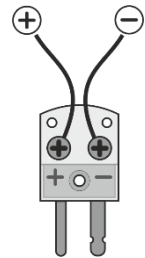

Terminals

Inputs (0 to 20) mA, (0 to 10) V, binary inputs and the counter are equipped with a two-part, self-locking WAGO terminal block. Insert flat-bladed screwdriver to rectangle terminal hole and push screwdriver towards away from you - contact is released. Insert wire to released terminal (circular hole behind the rectangular one) and close the terminal by removing the screwdriver.

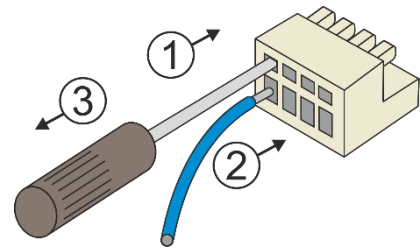

The terminal block can be removed from the device without the need to disconnect individual wires!

Connection of the binary and counter input:

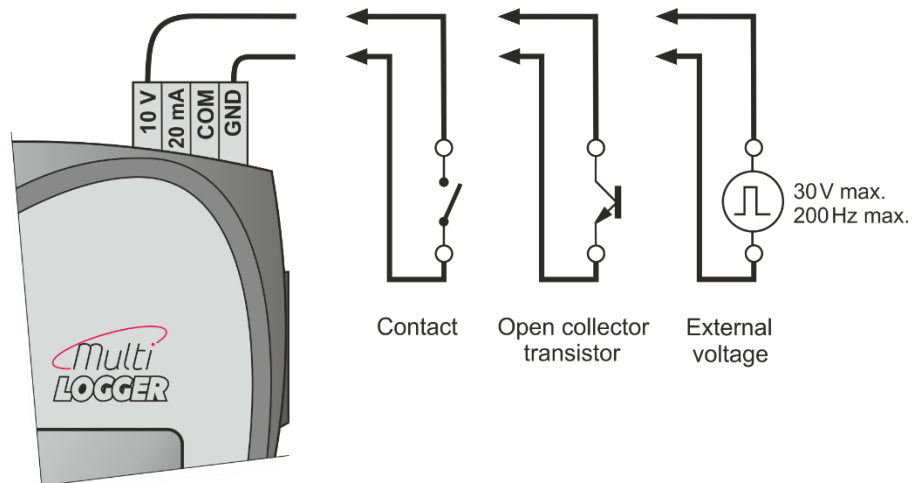

Connection of the transmitter with voltage output:

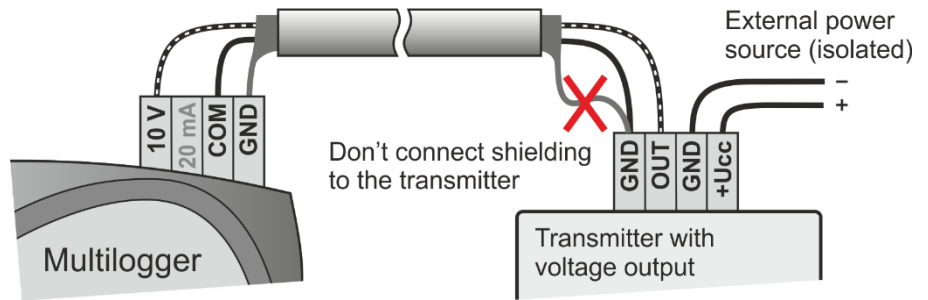

Connection of the transmitter with the current output (active):

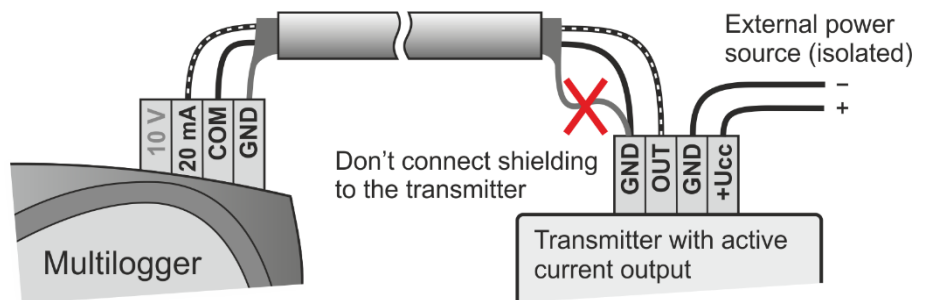

Connection of the transmitter with the current output (passive):

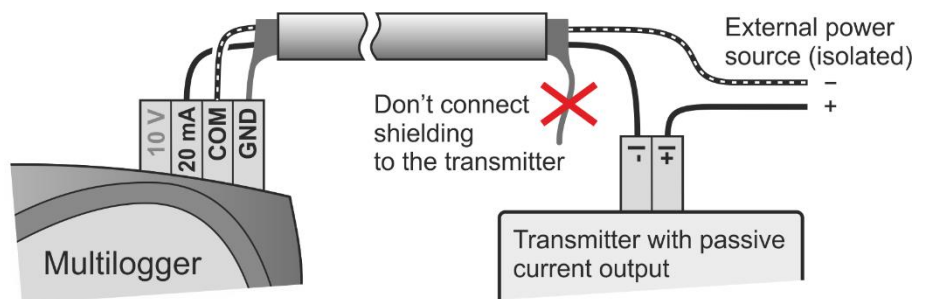

Connection of the transmitter with the two current outputs (passive):

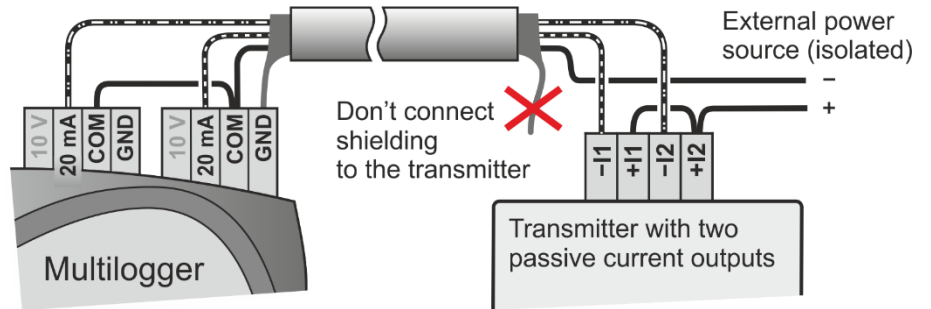

Alarm output

This output is accessible on terminals on the bottom side of the Multilogger. Here are available these signals: OUT - open collector transistor, +5V power supply from external power source and GND terminal (see also the diagram in *Appendix 2*).

As the default, this output transistor is switched during selected alarms. It is possible to set inverse behavior in the device's configuration (in this case loss of external power supply acts as an alarm state). Activity of this output can be canceled from the Multilogger keypad or remotely from a PC or web. Remember to set a suitable alarms delay to prevent false activity of this output.

It is possible to connect to this output:

- **External audio alarm** (*optional accessory MP026*) - connect the +5 V terminal with the central lead of the CINCH connector of the audio alarm unit and the OUT terminal with the outer lead of CINCH connector (see the picture).

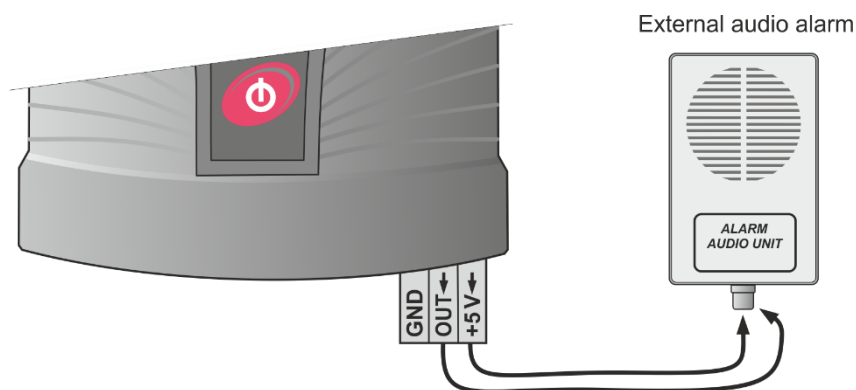

ATTENTION - the External audio alarm unit will not work if the Multilogger does not have an external power supply.

- **Telephone dialer** (*optional accessory MP002*) - in case of alarm telephone dialer dials specified telephone number and announces voice message. Connect the dialer according to its operation manual.
- **External alarm with its own power supply** - make the connection according to the following picture. Be careful do not exceed the maximum allowed output current from OUT terminal (see the part Technical Parameters). Use an external relay for higher currents.

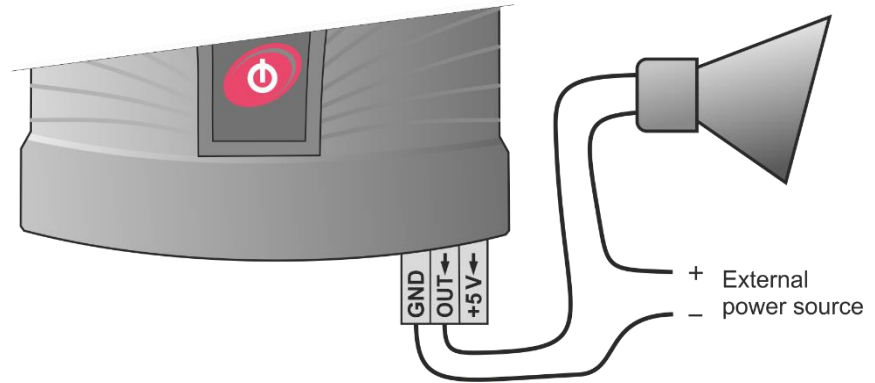

Power supply of Multilogger

The Multilogger is powered from three AA batteries and optionally also from an external +5 V DC power supply, which can be also used for charging the batteries. A simplified schematics of the internal supply circuits is showed in Appendix 2.

External power supply

- External power supply can be connected to the Multilogger in several ways:
 - a) to the power supply connector on the bottom of Multilogger (for example, AC adapter included in basic accessories)
 - b) to the terminal block of the RS232 interface (+5 V and GND terminals)
 - c) via USB cable connected to PC (it will work only if the USB port of the PC has current sufficiency to power the Multilogger)
- No energy from the batteries is discharged if external source is present.
- The Ethernet interface works only if an external power source is connected. Some limited functions of this interface may also be available during battery operation.



ATTENTION - never connect voltage greater than 5.5 V to the external power supply input - it could damage the device.

Batteries

- The new Multilogger is equipped with high-quality NiMH rechargeable batteries; the device is preset to intelligent algorithm to their continuous charging if external power is present.



ATTENTION - if you insert the non-rechargeable batteries to the Multilogger, change the battery model to *Alkaline* in the device configuration. Never charge batteries that are not rechargeable!

- Charging batteries:
 - a) batteries can be charged if an external power source is connected

-
- b) the charging process will start if the NiMH charging accumulators are selected in the device configuration
 - c) when the Multilogger is turned off, the batteries cannot be charged
 - d) the Multilogger allows for two battery charging modes - high current **fast charging** mode and low current **slow charging** mode
- Slow low current charging mode is mainly used for stationary installations. Batteries work as a backup source in case of external power failure. Charging is automatically activated after restoring of external power supply. During slow charging device operates normally. Recharging of completely discharged battery takes several days, however, in normal operation, do not expect a completely discharged battery. The charging process is indicated on the device display using the corresponding symbol .
 - Fast high current charging mode is mainly used for portable applications. Discharged batteries can be recharged within a few hours. The charging procedure has to be activated by the service personnel:
 - a) If the Multilogger is on, switch it off. Connect an external power supply to the device.
 - b) Press down and hold (approximately 3 seconds) the red On/Off key on the Multilogger until you see "NiMH charger" on the device display. The charging process is started.
 - c) During fast charging Multilogger does not work in the normal operating mode, does not take measurements and does not communicate with the PC.
 - d) Once the charging process is completed, the Multilogger displays the "Batteries charged" message and you can turn it off.
 - e) The charging can be proceed within a temperature range of 0 °C to +40 °C only. If the temperature is out of this range, the charging process is automatically stopped.

- Battery replacement:

If you want to keep the correct time setting in your device, do not let the battery discharge completely.

When replacing the battery, do it quickly. The timer circuit runs without battery for max. 5 minutes if the device is switched off.

- a) Switch the Multilogger off.
- b) Remove the battery cover, take out the old batteries and insert new batteries (take care for correct polarity). Battery polarity is shown on its holder.
- c) Switch the Multilogger on and make sure the set time is correct (device menu *View settings - General settings*).
- d) If you change the battery chemistry (rechargeable \Leftrightarrow non- rechargeable), **you have to** make this change in the device configuration also.

Note: The Multilogger can operate with removed batteries powered externally. This is not a standard use of the device but it is possible. In this case, the full battery is displayed. Interruption of power supply causes loss of time setting.

Keyboard operation

Control and indication parts

The front panel of the Multilogger includes 6 keys, 3 indication LED diodes and a graphic display.

- The red key with the switch symbol is used for Multilogger turning on/off. The MIN/MAX keys (with the arrows) are used for quick show of the minimal and maximal measured values and also for moving through menu items. Function of keyboard upper row buttons is defined by actual description of each button on the lower LCD line display.
- The indication LED diodes inform us about the current state of alarms and allows the operation personnel to observe this important information even under low light and from a greater distance.

green LED	no active alarms, "everything is OK"
orange LED	one alarm is active
red LED	several alarms are active or a system alarm (device malfunction)

- The green LED ("everything is OK") can be deactivated in device configuration to save energy. The indication LEDs can be enabled permanently or can be set to a blinking mode in battery mode to save energy also. If the measured quantity has both alarms set into the same direction, the LED diodes will indicate the current level of value: green - everything is OK, orange - exceeding the lower limit, red - exceeding the upper limit.

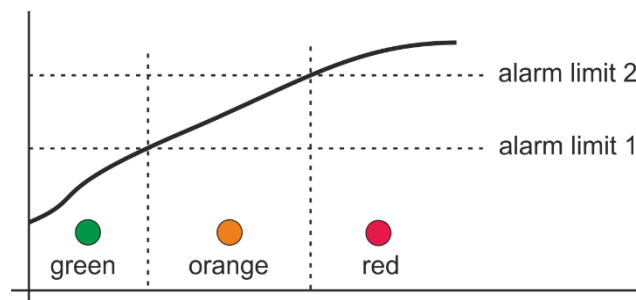

- The LEDs show an overview about all active alarms in the Multilogger. In the device configuration, we can assign individual alarms to the LED diodes for customizing the indication to our needs.

Basic display operation

Current measured values (or min/max) and their units are shown on the device display. To make it easier, the short description of measured quantity, the corresponding input number or a user description of the input, can be optionally displayed. Using the VIEW multifunction key, you can switch among these views on the display. You can choose from 3 different display options: input number + short description of measured quantity, input number without the short description of measured quantity and channel number + short description of measured quantity. If the Multilogger setup allows it, audio signaling of the currently active alarms can be temporarily muted using the MUTE multifunction key.

Numerical values of the measured quantities can be optionally displayed in three different font sizes according to user needs. When the smallest font size is selected, up to 6 quantities can be displayed together. When the largest font size is selected, the maximum number of the quantities that can be displayed together is 2. The maximum range of numerical values on the display is 7 characters (including the decimal point and sign "minus"). Exceeding this range is indicated as several dashes (-----), recording, however, is still running correctly.





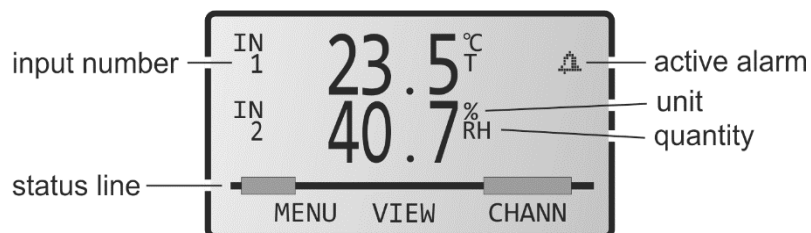









When the Multilogger is set for measuring more quantities or calculated channels, their viewing can be cyclically switched using the multifunction CHANN key. The order of the displayed quantities can be modified as needed.

The bell icon on the line of the measured value indicates an active alarm for this quantity.



The status line of the display shows icons that indicate the current status or device mode:

- FULL** full memory of non-cyclic record
- LOG** active recording

	active recording of analog values (in the “during alarm only” or “controlled by an external input” recording modes)
	inactive recording of analog values (in the “during alarm only” or “controlled by an external input” recording modes)
	external power supply present (if the status line is occupied by icons of a higher priority, it is not displayed)
	minimal measured values are displays
	maximum measured values are displays
	approximately one half of the battery capacity remaining
	battery is discharged, it needs to be replaced (alkaline batteries) or recharged (NiMH accumulators)
	battery charging in progress
	the data memory limit exceeded
	low voltage of the real time clock circuit detected, the time could be incorrect!
	alarm at least on one channel (the particular channel is marked with a bell by the given value)
	system alarm (alarm sources can be found in the System information menu)
	downloading of recorded data in progress (it is not displayed for MIN/MAX view mode)
	the Multilogger is being configured from a PC or via the web (it is not displayed for MIN/MAX view mode)

Main menu

Some device settings can be viewed or modified directly on the device using the keyboard.

- Main menu items:
1. System Information
 2. Viewing settings
 3. Change the Display
 4. Device Settings
 5. Clear Min/Max
 6. Clear Latched alarm
 7. Device information

1. System information

This menu item shows information that does not a part of device configuration and that describes the current status of the Multilogger:

- System alarm sources specify, what problem has caused the alarm, indicated by icon **! ALARM** on the display.
 - a) The **dash** next to the item description means that this item is not enabled for evaluation in the device configuration.
 - b) The **tick** next to the item description means that this item is enabled in the device configuration and that it is OK.
 - c) The **exclamation mark** next to the item description means that this item is enabled in the device configuration, however, it is not associated to the LED, audio or alarm signal indication and it is in error state.
 - d) The **bell** next to the item description means that this item is enabled in the device configuration, and it is associated to the LED, audio or alarm signal indication and it is in error state.
- System information items:
 - a) Remaining battery capacity (0-100%).
 - b) Data memory occupation in %.

-
- c) Real time clock circuit state: **tick** - OK, **exclamation mark** - low voltage of the real time clock circuit detected, the time could be incorrect!
 - d) Activities of the Alarm out signal: **tick** - active, **field without a tick** - inactive.
 - e) MUTE activated: **tick** - was activated (alarm is still active), **field without a tick** - was not activated (or the alarm is inactive).
 - f) Activities of EN signal: **tick** - active, **field without a tick** - inactive.
 - g) battery voltage: range from 3.4 V (completely discharged battery) to 4.5 V (new or just charged battery)
 - h) device internal temperature (affects the battery charging)
 - i) cold junction temperature of the thermocouples (only for models with a thermocouple connector)
 - j) Multilogger firmware version.

2. Viewing settings ---

Allows to view the following settings:

- **record settings** (recording interval, cyclic record, record on alarm, record of the average and min/max values per logging interval)
- **general settings** (LCD backlight intensity, battery type, menu language, date and time in the device)
- **alarm limits** (limit values, hysteresis and delay for each existing channel and alarm. You can change channels using the arrow keys).
- **alarms indication** - information about settings of alarm signalization (optical, audio, Alarm Out) and if it is enabled to temporarily deactivate the alarm signalization (MUTE function)
- **memory occupation** - information about alarm limit of data memory occupation and signalization of this alarm (optical, audio, Alarm out signal)
- **Ethernet interface** - information about LAN parameters (device IP address, gateway IP address, network mask, IP address of the DNS server)

3. Display settings ---

Allows to set the parameters of the displaying:

- Font size (large, medium, small)
- Displaying input description of the measured quantity (yes, no)
- Order of the displayed channels (based on the input number, based on the channel number, selection)

4. Device Settings ---

Access to this submenu can be protected by a PIN1 code. Recording is stopped after entering into editing mode. If no key has been pressed for 5 minutes in the editing mode, the device restarts with the last settings. The following parameters can be edited:

- **recording parameters** (recording interval, start/stop recording)
- **general settings** (LCD backlight activity&intensity, battery type, menu language)
- **alarm limits** (limit values and alarms directions can be set for each existing channel and alarm. You can switch from one channel to another using the arrow keys).
- **alarm indication** - enable or disable of alarm signalization (optical, audio, Alarm out signal). Setup of MUTE function - temporary deactivation of audio and/or Alarm out signalization.
- **memory occupation** - limit and signalization (optical, audio, Alarm out signal)
- **Ethernet interface** - network parameters (device IP address, gateway IP address, network mask, IP address of the DNS server)

5. Erase Min/Max ---

Erase of the Min/Max memory of either all measured quantities (“All channels” option) or selected measured quantities (“Individual channels” option) by the user. This function can be protected using PIN2.

The Min/Max values will be erased automatically if the device happens to be without any power supply, for example, when replacing its batteries.

6. Deactivation of Latched alarm _____

If the “Latched alarms” function is enabled in the device configuration, the active alarms are not reset when the measured values return back to the allowed limits. Instead, they remain active until they are deactivated by the user. They thus warn us that “something was happening” during the monitored period, i.e. that the alarm limits were exceeded. This function can be protected using PIN2.

7. Device information _____

The 32-character user description of the Multilogger, device model and its serial number are displayed here. The next screen displays a summary of the configuration of individual inputs.

Connecting with the computer

You can connect the Multilogger to the computer through the following communication interfaces:

- **USB** - fast connection for short distances (up to 5 m, communication speed of 460,800 Bd). Connect the device to the computer using the supplied cable, launch the SW and add Multilogger to the list of your COMET devices.
- **RS232** - slow connection for distances of up to 15 m, designated mainly for communication via GPRS modems (communication speed of 115,200 Bd / 230,400 Bd).
- **Ethernet** - fast connection for long distances. An external power supply source has to be connected to the Multilogger (for example, a power supply adapter). The device IP address is preset to 192.168.1.78, the default sub-net mask is used as well as port 10001 (we recommend not changing the port number if it is not necessary).

Configuration:

- a) Verify if you can use the preset IP address with your network administrator. If not, obtain a new IP address, network mask, gateway address and address of the DNS server from him/her.
- b) Set these parameters on the Multilogger (Menu - *Device settings* - *Ethernet interface*). Alternatively, you can connect the Multilogger via USB interface and do the above stated configuration using the *COMET Vision* software.
- c) Connect the Multilogger into your LAN (Ethernet cable is not included as device accessory).
- d) Launch the *COMET Vision* software and add the Multilogger to the list of your COMET devices.

The Multilogger automatically identifies which communication interface is connected and will use it for communication. When multiple interfaces are connected, USB has the highest priority and Ethernet the lowest. For example, if Multilogger has to work over Ethernet, no USB or RS232 interface can be connected to the device.



ATTENTION - we recommend using the supplied power adapter for battery charging. When you use a USB charger, the Multilogger may not communicate when the charger is connected!

Software COMET Vision

Hardware and system requirements _____

- the Windows 7 and later or the Windows Server 2008 R2 and later operating system
- 1.4 GHz processor
- RAM 1 GB

Program description _____

The *COMET Vision* software can be used for device configuration and for obtaining recorded data and currently measured values. The device can be connected via USB, Ethernet or a serial port.

The program is available for free (at www.cometsystem.com) or as a paid version. The free version allows work with one device at the same time and contains the basic functions only. The paid version lets you connect any number of devices that can work simultaneously (for example, downloading data from several devices at the same time, having multiple displays launched, etc.) and will also give you access to advance functions (for example, charts, statistical overview of the recorded data, custom display, export to the database, etc.).

Adding the Multilogger to the list of COMET devices _____

The device can be added by clicking on the “add device” button (you can find it under the “Welcome” menu, which is displayed upon the first launch of the program, or also under the “Home page of the device” menu, under the “Devices” option). A menu with a selection of connection types is displayed (USB, Ethernet, Serial); for USB and Ethernet, you can select device from the list of offered devices; for serial line, you have to select a communication port, to which the device is connected. Finally, confirm your selection using the “Finish” button and the device will be added.

Automatic detection can be used for devices connected via USB. Once the device is connected to your computer, the device is automatically added to the list of COMET devices (within about 5 seconds - time necessary for the device initialization).

When connecting device via USB the baudrate is 460,800 Bd, while RS232 the baudrate is 115,200 Bd.

How to work with the program _____

The main menu of the program is on the right side with items: “Home”, “Devices”, “Files” and “Online Displays”. These components control appearing bookmarks. Each item has its bookmarks, one of them named “Home” is similar for all items. The other options are specific for each item.

Device setup using software

Upon being the Multilogger switched on using the red button, the device begins to take measurements and to record and evaluate alarms according its user configuration. Complete configuration of the device can be done using the *COMET Vision* software. Some parameters can be changed from the device keyboard or from its web pages. When editing the Multilogger configuration, the device normally works, however, access to some of its functions is limited (downloading records, editing of the device configuration by other users).

Device configuration basics

- Connect the Multilogger with your computer and launch the *COMET Vision* software.
- If the software not communicated with this device yet, add Multilogger to the list of your COMET devices. For more information see part "CONNECTING THE MULTILLOGER WITH THE COMPUTER".
- If the Multilogger is correctly connected, the *Device Home* panel displays its current status.
- Click on the *Configuration* button. The device configuration is loaded and you can view or edit it.
- When you make a configuration change of any items, the SW goes to the editing mode and limits the device access for other users now.
- Upon a long user inactivity period, the editing configuration mode is automatically terminated.
- Finally, save the new configuration to the Multilogger (*Apply changes*).

Device configuration items

General - Information _____

Here are displayed the basic information about the connected Multilogger. It includes its name (*Device name*), which is used for identifying your device and its measured values. The instrument can be named according to of its application or you can use the default name. The maximal length of the *Device name* is 32 characters - use letters, numbers, underscore characters, etc. Moreover, this panel states the serial number, model name and firmware version.

General - Preferences

Here you can select language localization *Language on the device terminal*, *Default temperature unit* °C/°F and, for some models, *Atmospheric pressure unit*. If your model does not measure atmospheric pressure but it is necessary to know it (for calculated humidity values and CO₂ concentration), you need to specify *Ambient average pressure*.

For barometers, you can enter a correction constant for sea level recalculation as the actual sea level pressure or altitude. Actual sea level pressure can be obtained from, for example, nearby observatory or nearby weather station.

General - Date and Time

Here you can set the date and time in Multilogger (*Date and Time*). In the device is running the local time. Use *TimeZone*, if you can determine its relation to UTC. This information will be available for all timestamps from the device (record, online monitoring). The Multilogger does not allow for automatic changes between the summer and winter times.



ATTENTION - after change the date and time, the recorded data in the Multilogger will have to be deleted!

General - Advanced - Energy

The Multilogger running in the standard mode will measure all inputs once per second (with the exception of measuring CO₂ concentration, which will be measured every 2 minutes). The advantage is a fast response of the device, the disadvantage is its higher current consumption if the device is powered from batteries only. If you operate the Multilogger from batteries for a long time and you do not need a fast response time, you can use the energy saving mode (*Energy saving mode*), under which the device consumption from the batteries will significantly decrease, however, the measurement interval will be extended to 10 seconds (10 minutes for CO₂ concentration). Consumption details can be found in the *Technical Information*.

General - Advanced - Device start _____

Here you can disable the “Off key” of the device.

General - Advanced - LCD Display _____

These settings are used for optimizing the backlight of the display in relation to your application. As a default, the Multilogger is set in a way that the backlight (*LCD backlight activity*) is activated only for several seconds upon the last key pressing. If, however, you need to ensure a good visibility of the display in the mains powered fixed installation, turn on the backlight activity only when the external power supply is on and choose a suitable intensity (*LCD backlight intensity*). If the backlight is permanently turned on while Multilogger is powered from the batteries, they discharge relatively fast, therefore do not use this setting. Turn the backlight off for applications, for which is required the longest battery life.

General - Advanced - Peripherals _____

There you can set the activity interval and baudrate of the external GPRS modem, which is connected to the RS232 interface of the Multilogger. In addition, there can be set power management of the Ethernet interface.

If you set the interval of the turn-on procedure of the GPRS modem, the Ethernet interface of the Multilogger will be deactivated.

Ethernet in battery mode

The Ethernet interface does not work without external power supply. However, this interface can send a warning e-mails and records to the database using *DataLink* protocol in the battery mode if you turn on this feature. These messages will be sent immediately after power failure or on new alarm. Additionally, they can be sent repeatedly at the specified interval.

Warning – Ethernet interface in battery mode significantly reduces usable battery capacity. If your LAN is not backed up do not use this options.

Record

This options are used for controlling the record functions of the Multilogger. Recording can be turned on and off as needed (*Recording On/Off*). However, if the record is turned off and then you turn it on again, this takes up 0.1% of the free memory capacity. Use the *Cyclic record* if you require the device to continue the recording even when the data memory is completely full. In this case, the oldest data are replaced by new ones. If you do not use this option, the recording will stop once the memory is full. Another important parameter is the *Recording interval*. It can be set from 1 second to 24 hours (see the *Technical Information*). The recording is performed in integral multiples of a set interval. For example, if you turn the device on at 5:05 a.m. and if you have set the logging interval at 1 hour, the first data will be recorded at 6:00 a.m., next ones at 7:00 a.m., etc.

Recording can be continuous or, alternatively, records can be taken only if any measured quantity is in the alarm state (the system alarms does not trigger recording). Moreover, Multilogger with binary input No. 3 also offer the option to control the recording by the status of this binary input. These settings can be performed in the section *Recording mode*.

By default, the device records the actual values at the time of the recording interval. However, if continuous recording is on (see above), you can select recording of average, minimal and maximal values during recording interval. These settings can be performed in the section *Recorded values*.

The last thing to do when configuring the recording is to select the measured quantities that you want to record (see the *Inputs* panel described below).



ATTENTION - upon changing cyclic ↔ non-cyclic recording, you will need to erase all the recorded data saved in the device!

Alarm events - Signalization

The Multilogger allows to evaluate alarm states, which can come from the measured quantities or which can signalize some device problem (exceeding of the data memory occupation limit, system alarms). For each alarm it is possible to assign the method of their signaling to the user.

Alarms can be signaled using the LED diodes directly on the Multilogger (*Optical signalization - LED*). Since the Multilogger can work in the battery mode, additional options are available for minimizing the current consumption. For a state without an alarm can be selected green LED indication. When the device is powered from batteries, you can select more energy economical mode, under which the LED diodes only shortly blink in the case of an alarm.

In addition, the alarm can be signaled acoustically with characteristic sound that is repeated at regular interval. Service personnel can easily confirm the audio signal and thus make it silent until a new alarm occurs. These settings can be performed in the section *Mute of signalization*.

Alarm signaling can be also performed using the ALARM OUT output. Upon an alarm, the Multilogger can switch on the open collector transistor of this output in accordance with the description in Chapter "ALARM OUTPUT". This transistor can be optionally switched on or switched off when there is an alarm. The *Mute* function can be also used for this output.

Alarm events - Preferences

In the standard mode, the alarm exists if the measured value is out of limits, and the alarm becomes inactive if the measured value returns to its limits. In some cases it is suitable that the user, who comes to the device after a longer period of time, can easily make sure that no alarm has occurred while he/she was gone. If you activate the *Latched alarms* option, all alarms that occur in the Multilogger will remain active until the service personnel is not confirmed them.

Here you can also allow remote erasing of the alarm memory and remote deactivation of alarm signalization from the software *COMET Vision* or from the web (*Remote Mute & Erase of Latched alarms*); moreover, you can permit or forbid alarm deactivation from the device keyboard (*Local Mute enabled*). To protect access to these functions, you can use the PIN2 code (Security panel).

Furthermore, you can allow alarm evaluation here only on certain days of the week and within defined range of hours per day. It is not suitable to combine this setup with the above described *Latched alarms* option.

Alarm events - Mute of signalization _____

The *Mute* function is used for deactivating alarm signalization by the user. It can be optionally applied to audio signalization, the ALARM OUT output or both. It can be performed from the keyboard, from the web or from the software *COMET Vision*. To protect access to these functions, you can use the PIN2 code, which the operation personnel must enter. This function deactivates enabled alarm signalizations until a new alarm occurs. The deactivation can be permanent (until a new alarm occurs) or temporary (if the alarms remain active even after selected time out, the signalization is restored).

Alarm events - Memory occupation _____

If you need to indicate exceeding of your specified limit of the data memory occupation, use the setup in this section. The signalization can be selected as optical (red LED diode), audio, or by the means of the ALARM OUT output activation or sending email to selected recipients.

Alarm events - System failure _____

The options in this section allow for setting up the *System alarms* which respond to the Multilogger or probes malfunction. The signalization can be selected as optical (red LED diode), audio, or by the means of the ALARM OUT output activation or sending email to selected recipients.

The Multilogger can respond to the following states:

- a) *Measurement error on any channel ...* for example, a disconnected or damaged probe
- b) *Device configuration error ...* an unexpected device configuration error
- c) *Selftest error ...* empty battery
- d) *External power lost ...* failure of the external power supply source

Security

The Multilogger allows an easy security option by the means of PIN codes:

- PIN1: protection against unauthorized changes of the device configuration (from a PC or device keyboard), erasing of data memory and counter erasing
- PIN2: protection against unauthorized alarm deactivation (*Mute*), confirmation of alarm memory (*Latched alarms*) and erasing of the Min/Max values

Ethernet - General

Here, you can make the basic connection setup of the Ethernet interface. To obtain some information, you will need to contact your computer network administrator. First of all, you have to find out if you are going to use a fixed IP address or if it will be assigned by the DHCP server in your network. Based on the answer, select the appropriate option (*Obtain an IP address automatically - DHCP*). If you do not use DHCP, enter a unique IP address of the Multilogger, assigned to it by your network administrator (*IP address*). By default, the device address is set at 192.168.1.78. Keep the port number (*Port*) at 10001, unless you have a reason to change it. If communication is performed between different network segments, you need to enter the gateway address (*Default gateway*). If you use domain names instead of IP addresses in some of the following setups, you have to enter the IP address of your DNS server (*DNS Server IP*). Under standard networks use the default *Subnet mask*, which is set automatically pursuant to class A, B or C. If you use a network with a non-standard range, the mask have to be entered manually. You usually do not have to change the size of the block transmitted through the network (*MTU size*), thus keeping it at 1,400 bytes.

External power supply is required for full operation of the Ethernet interface. Some limited functions of this interface may be available for battery operation. See part *Device setup using software, General - Advanced – Peripherals, Ethernet in battery mode* options.

Ethernet - Email - General

Here you can do the basic email setup. If you want to use the sending of warning emails on alarms, switch this function on (*Email sending ON*). Next, set the IP address or SMTP server or its domain name (*SMTP Server*), port (*SMTP Server port*) and, if the server requires authentication, enter your login name and password (*Authentication*). Continue by entering addresses of up to three recipients of the warning emails (*Email recipient #1 - #3*) and, finally, enter the address of the email sender (*Sender*). This is usually the same as the user name in the SMTP authentication.

Ethernet - Email - Preferences

Here you can set further email parameters. If you want the Multilogger to send the regular emails during the active alarm, enter of their interval (*Repeat alarm sending interval*). If you enter 0, the email is sent only upon the start activity of alarm and upon end its activity. Moreover, you can set sending of a regular informative email, which informs the user that the Multilogger is working properly (*Keep alive email sending*).

You can use shortened emails (*Short email*) especially for forwarding them as SMS messages to mobile phones. You can also insert your own comments to the emails: if the alarm appears (*Alarm note*), if the alarm expires (*Clear alarm note*), in the case of system alarm (*System alarm note*) and in the case of exceeding the memory occupation limit (*Memory overflow note*).

Ethernet - Datalink

The Datalink protocol is used for connecting the Multilogger with the COMET database system. Connection to the server is opened by the Multilogger in regular intervals. Further control of the communication is then performed by the server. If you want to use this function, you have to allow it (*Datalink On*). Next, enter the IP address or Datalink server or its domain name (*Datalink address*), communication port number (*Datalink port*, default is 10002), connection opening interval (*Datalink interval*) and the database key (*Datalink key*). If you require to send the irregular alarm messages using this protocol, you need to allow asynchronous transmissions (*Asynchronous communication*). Moreover, you can also set here the data downloading interval and possibility of erasing recorded data in device.

Ethernet - Web

The Multilogger has its own web pages, where you can monitor currently measured values and alarm states, and where you can change some configurations. First of all, you have to allow the website option (*Web pages On*). If necessary, you can change the port number (*Web server port*), which is set at 80 by default. If you want to make configuration changes through the website, you have to allow this function (*Use web for device configuration*).

Ethernet - SNMP

The Multilogger allows for uploading the online measured values and alarm states using the SNMP protocol. This protocol is always active. Enter the password for reading (*SNMP Read Community password*). The MIB tables can be downloaded from the web of the manufacturer.

Inputs

Here you can specify the quantities that you will measure on every one inputs, their recording and alarm states. You can see a simple list of all inputs and measured quantities on the screen.

First of all, specify the probe or signal types connected to each input (*Settings* button). Here you also choose the measured quantities that you will acquire from this probe or input. You can acquire multiple quantities at the same time from some probes (*for example, temperature, relative humidity, dew point, etc.*). However, you can also decide not to use a specific input, in this case click on *Clear* button or remove all set measured quantities. You can name the input by your own name (*Input name*), which you will then see by all measured values. Once you are done with this configuration, you can return back to the list of inputs and measured quantities.

Now, when you have correctly set your inputs and selected measured quantities, you can configure them in more details using the *Edit* button. For each measured quantity, you can choose if it should be recorded (*Recording*) and if you wish to use the default setting (*Basic settings - default*) of the physical unit (6 characters), short description of the measured quantity (4 characters) and number of decimals. However, you can also opt for your own setup (*Basic settings - custom*) and enter the stated items manually. If you need the convert

the measured values to different values using a two-point linear transformation, turn on the User calibration function (*User calibration*). For example, you can use it for converting current values measured using the current loop to a different physical quantity or for applying recalculation to the measured values.

Example of user calibration settings for a sensor with a current output (4 to 20) mA connected to the current input of the Multilogger, with a range of the sensor between -30 and +80 °C:

Upper point B: Input value: 20 will be shown as 80

Lower point A: Input value: 4 will be shown as -30

In the next step, set alarms for individual measured quantities. You can set up to 2 alarms for each measured quantity (*Alarm 1* and *Alarm 2* buttons). Each alarm has to be enabled first (*On/Off*).

Next, select if the alarm occurs upon exceeding or dropping under the given limit value (*value is greater than / value is lower than*) and enter this limit. For binary inputs only define the state of the input. Next, you need to specify the alarm delay (*for the duration of*), which is used for eliminating short-term exceeding of the limit value. Hysteresis has a similar function (*Alarm hysteresis*) - it is used to prevent alarm oscillation when the measured value fluctuates nearby the alarm limit. We recommend not to set it at zero. We have hereby completed the setup for alarm occurrence. Now we just need to specify if the alarm will be indicated optically on the Multilogger (*Optical signalization - LED*), acoustically (*Activate internal audio signalization*), by the ALARM OUT output (*Activate ALARM OUT output*) or by submitting a warning email (*Send email message ...*).

In some application, we want to calculate other values from the measured ones, and we want to be able to record them and to create alarm states. The Multilogger allows this by the means of several simple mathematical operations (difference, linear equation, multiplication and division). This way, you can, for example, easily calculate the difference between the surface temperature and the dew point of the air. Calculated values can be defined on the section with a list of inputs and measured quantities by clicking on the given line button *Calculated - Add*. Their further settings are specified similarly to the measured quantities (with the exception of the *User calibration*, which cannot be used for the calculated quantities).

Applications notes

Recommended settings for the portable application _____

In this application, the Multilogger is powered from batteries and a fast response time and an easy battery recharge after the measurement are required. Recorded data are downloaded after measurement.

We recommend to use the Multilogger with NiMH accumulators; specify the following device configuration:

- NiMH accumulators (if they are installed).
- Do not turn on the *Energy saving mode*. The Multilogger will perform measurement with a fast sampling (1 second for all quantities with the exception of CO₂ concentrations, which will be measured every 2 minutes).
- Switch off the display backlight or allow it only upon pressing a key. Active backlight drastically reduces the battery life. However, even when it is permanently on, the Multilogger with fully charged batteries will operate about one week with the lowest backlight intensity (25%).
- Switch off the optical alarm signalization using the LED diodes or, if necessary, allow only the orange and red LED diodes working in a flashing mode while the Multilogger is powered from batteries.
- If you are not going to use the audio alarm signalization, turn it off.

For measurement of room temperature and humidity using the Multilogger powered by batteries, short probes without cable are recommended (DigiL/M, DigiS/M and 200-80/M models). When these probes are used, the device is the compact unit.

Empty batteries can be easily recharged once the measurement is completed using the fast charge option.

Recommended settings for the stationary application permanently connected to the Ethernet _____

In this application, the Multilogger is powered from an external power supply most of the time. It is required that the measurements and recordings continue even during any power supply failure. Once the power supply is restored, the data acquired during the given power failure must be available and the batteries have to be automatically recharged.

We recommend to use the Multilogger with NiMH accumulators; specify the following device configuration:

- NiMH accumulators (if they are installed).
- Do not turn on the *Energy saving mode*. The Multilogger will perform measurement with a fast sampling (1 second for all quantities with the exception of CO₂ concentrations, which will be measured every 2 minutes).
- Switch on the display backlight as needed. If it is necessary to make the measured values on the Multilogger well visible all the time, turn the backlight on only when the device is powered from an external power supply.
- Use the optical alarm signalization using the LED diodes as needed.
- Set the audio alarm signalization as needed.
- If you want to operate the Multilogger “remotely”, disable “Off key” on its keyboard (*COMET Vision* software, option *General - Advanced - Device start*). You will thus prevent unauthorized or unwanted device turn-off by unqualified personnel. In these cases, it is also advisable to limit access to the device configuration from the keyboard using PIN codes.
- If your LAN is backed up and works correctly during mains failure, it is possible to send warning e-mails and records to COMET database (DataLink). See part *Device setup using software, General - Advanced – Peripherals, Ethernet in battery mode* options.
- **Attention** - if you use an external audio unit powered from the Multilogger, it will not work during external power supply failure!

For measuring of room temperature and humidity using the Multilogger powered from an external power supply and with an active Ethernet interface or charger, probes with cables are more suitable. Short probes without cables (DigiS/M, DigiL/M or 200-80/M) can be used but the measurement accuracy will worsen due to the waste heat created by the Multilogger. The other sources of the waste heat are there - battery charger or the display with backlight that is permanently turned on (especially in the case of higher backlight intensities). The measurement error can reach approximately +1 °C for the device installed on an inside wall without forced ventilation.

After an external power failure, when the device was running from the batteries for a while, the batteries are automatically recharged by low current as soon as the external power is restored.

Recommended settings for a long time battery powered application

In this application, the Multilogger is powered only from batteries and a fast response to changing measured quantities is not required, however, it is required that the device runs from the batteries as long as possible. Recorded data are downloaded after measurement.

We recommend to use the Multilogger with NiMH accumulators; specify the following device configuration:

- NiMH accumulators (if they are installed).
- Switch on the *Energy saving mode*. The Multilogger will perform measurements with a slow sampling (10 second for all quantities with the exception of CO₂ concentrations, which will be performed every 10 minutes).
- Switch off the display backlight or allow it only upon pressing a key. Permanently activated backlight drastically reduces battery life.
- Switch off the optical alarm signalization using the LED diodes or, if necessary, allow only the orange and red LED diodes working in a flashing mode while the Multilogger is powered from batteries.
- If you are not going to use the audio alarm signalization, switch it off.

For measuring of room temperature and humidity using the Multilogger powered by batteries, short probes without cable are recommended (DigiL/M, DigiS/M and 200-80/M models). When these probes are used, the device is the compact unit.

Empty batteries can be easily recharged once the measurement is completed using the fast charge option.

How to set the Multilogger for measuring of calculated humidity values or CO₂ concentrations

You can measure other humidity quantities on the input, with humidity-temperature probe of the Digi line and work with them. You can measure one as well as multiple humidity quantities together. For some calculated humidity values and for CO₂ concentrations, you need to know the value of the current atmospheric pressure.

If the Multilogger is not equipped with an internal pressure sensor, you have to enter this value using the SW in the device configuration, item *General - Preferences*. You can enter either the current pressure value at the given location (without conversion to the sea level) or the current altitude.

How to set the Multilogger for measuring the difference of two temperatures _____

To do that, use the calculated measured quantity (*Calculated*). First of all, select input quantities that will be used in the calculation formula. Next, set the other items analogically to the other measured quantities. In addition to the calculating of difference, other simple mathematical operations are possible.

System alarms and how to work with them _____

System alarms are used for diagnostic functions of the device and probes connected to it. A system alarm signals a malfunction or damage of the Multilogger or its probe. Unlike the alarms from measured quantities which signal the problem of the technology that the Multilogger monitors. A system alarm can be reported to a different person than alarms from the measured quantities.

What is the inversion setup of the ALARM OUT output ____

By default, the ALARM OUT output is set in a way that its output transistor is switched on during alarm state. For better security, this output can operate inversely, i.e. the transistor is switched on when there is no alarm and switched off during alarm state. In this case, disconnecting a cable, turning the device off, etc. represent an alarm.

Backup and restore of device configuration _____

If you have set the whole system and you need to back up its setting with the possibility to upload it to the same or even different Multilogger, download recorded data from device. The saved file contains complete configuration of the Multilogger, which you can upload back to the device.

How to set a variable alarm limit

In some applications, you need the alarm limit to depend on another measured value.

Example: *we require that the alarm must be activated when internal temperature T_{int} becomes by 3 °C higher than exterior temperature T_{ext} . In this case add another calculated quantity that will be the difference of both measured temperatures $T_{int} - T_{ext}$. The alarm limit for this quantity shall be 3 °C. The alarm then occurs if $(T_{int} - T_{ext}) > 3$ °C.*

Selftest error

The selftest is used for monitoring the state of the batteries. If the Multilogger reports this error, the batteries are empty. You can check the battery status in the System information menu or in the software *COMET Vision* on the Device home page. If the battery voltage drops under 3.45 V, the Multilogger reports a self-test error. A drop of the power supply voltage is also indicated by the given symbol  on the device status line. The batteries have to be recharged or replaced.

Measurement accuracy problems

In a majority of cases, incorrectly measured temperature and relative humidity values are caused by an incorrect position of the probes or measuring method. Some comments related to this topic are shown in the next Chapter, *Operation and maintenance recommendations*. When measuring room temperature and/or relative humidity using a short probe without a cable and with permanently active Ethernet interface, measurement accuracy can slightly worsen due to the waste heat generated in the device. It especially problem of stationary installations on the wall with insufficient air flow.

When measuring temperature using thermocouples, you have to make sure that neither the measuring ends, nor conductors are connected to any conductive parts that may cause unwanted couplings. This may, in exceptional cases even cause damage the device.

A similarly for sensors with a voltage or current output - unwanted couplings can cause incorrect measurements.

If the Multilogger reports an error state, you can find more information in *Appendix 1 - Selected error messages*.

Another group of problems are random spikes of the measured values. Most commonly, they are caused by a source of electromagnetic interference located in the proximity of the device or cables. Furthermore, you have to also make sure that the insulation of the cables is not damaged and that conductors thus do not make any incidental connections with other metal parts.

PC communication problems ---

If the Multilogger communicates via USB interface, do not use cables longer than 5 meters. Connecting and disconnecting the cable while the communication is in progress can cause temporary unavailability of the USB device in the computer. In this case, it may be necessary to close and re-launch the SW (including the communication service). If this does not help, restart the computer.

If you communicate with the Multilogger via Ethernet interface, make sure that nothing is connected to the USB port of the device. Some USB chargers can deactivate the RS232 and Ethernet interfaces. Use the supplied AC adapter to external power of device and for charging the batteries.

If Multilogger does not communicate via Ethernet, try USB communication. If that is working, some settings of the Ethernet interface will most probably be incorrect (such as the gateway address etc.).

Operation and maintenance recommendations

Device operation in various applications

Before application it is necessary to consider if Multilogger is suitable for required purpose, adjust optimal configuration and create instructions for its periodical metrological and functional inspections. **Since the Multilogger can be powered from the power mains, it is necessary (depending on the character of the application) to secure the appropriate electric revision of its installation and its regular inspections.**

Unsuitable and hazard applications: The Multilogger is not designed for applications, where failure of operation could cause endanger of health or function of other life supporting devices. In applications, where failure of Multilogger could cause loss on property, it is recommended to amend system of independent indication device to monitor this state and avoid damages. You have to be especially careful with regard to the alarm output with a connected external audio unit, functionality of which is depended on external power supply source.

Locations of temperature sensors: place them to locations with sufficient air flow and where most critical point is supposed (in accordance with application requirements). The sensor has to be sufficiently inserted into the measured area or sufficiently connected to it in some other way, thus preventing the measured values to be influenced by undesired heat coming from the conductors. *When monitoring temperature in an air-conditioned warehouse, do not place the sensor in the path of the direct air flow from the air-conditioning units. The thermal field can sometimes be very inhomogeneous (for example, in large chamber refrigerators) and the deviances can reach up to 10 °C. Similar deviances can be found in deep freezers (used, for example, for freezing blood etc.).*

Locations of humidity sensors depend on the application requirements. Measuring humidity in the refrigerators that do not have an additional humidity stabilization system can be very problematic. When turning a cooling system on/off, significant humidity changes amounting to several tens of percentage points can occur even though the mean humidity value is correct.

Recommendations for metrological verification _____

Metrological verification is performed in accordance with application requirements specified by the user. In some cases, calibrations must be performed by the accredited laboratory. The manufacturer recommends to perform these verifications once a year.

Note: accuracy of Multilogger input means accuracy of input itself without probes.

When verification of thermocouple inputs it is necessary to take into account that cold junction compensation is performed inside of Multilogger, where temperature is somewhat higher than ambient temperature on the outer connector. This fact can sometimes cause problems when performing verifications using the electric simulators of the thermocouples. The best way is to do the temperature verification together with the thermocouple.

Recommendations for periodical inspections _____

The manufacturer recommends to perform regular inspections of the system, into which the Multilogger is included. The interval and range of the inspections depends on the particular application. The following inspections are recommended for stationary installations:

- metrological verifications
- regular revisions and inspections subject to the intervals specified in the corresponding standards
- assessments of all problems that occur since the last inspection
- visual inspection of the device and checking of the connectors
- device functionality inspections (i.e. the functions used for a given application):
 - a) verification of data transfer to computer
 - b) verification of alarms - change input value to activate alarm and check display message and alarm signalization (if used)
 - c) check the battery voltage (in device menu)

-
- Verification of cabling - check the connection quality of cables, check visually entire cable length for damage and the route of cables for interference, especially whether some parallel power wires are not near.
 - Visual inspection of sensors - perform their visual inspection and make sure no water has leaked inside the sensors; moreover, verify that their locations are suitable from the perspective of measuring accuracy as well as possible interference.
 - Make a verification protocol.

Service recommendations _____

Technical support and service are performed by the devices' distributor. Its contact is given in the warranty certificate, supplied with the Multilogger.



ATTENTION - damage due unauthorized manipulation will cause the warranty to expire!

Placing out of operation after the end of the device life ____

Disconnect the power, remove batteries and return data logger to the supplier or specialized company as electric waste.

Technical parameters

Power supply

The Multilogger is powered from batteries located under the removable cover on the rear side of the device. An external power supply source can be also connected to the Multilogger. When the device is connected to an external power supply, the batteries are not used. If you want the Ethernet interface to work, this external power supply voltage has to be connected. However, some limited functions of this interface may be available for battery operation (see *Device configuration: General - Advanced – Peripherals - Ethernet in battery mode* options). Batteries can be recharged in the device.

Batteries

Recommended battery type:

3x AA NiMH rechargeable batteries Sanyo ENELOOP
1,900 mAh, 1.2 V

Alternative batteries:

3 x AA alkaline battery 1.5 V

*When alkaline batteries are used, **it is necessary** to disable the charger in the device configuration, i.e. to set the Multilogger for Alkaline batteries.*

Operating time of fully charged NiMH batteries:

> 1 month in the standard measuring mode
approximately 6 month in the power saving measuring mode

Applies to Multilogger without CO₂, with fully charged batteries of the recommended type; when the display backlight, LED indication and audio signalization are turned off.

> 3 weeks in the standard measuring mode
approximately 3 month in the power saving measuring mode

Applies to Multilogger with CO₂ with fully charged batteries of the recommended type; when the display backlight, LED indication and audio signalization are turned off.

Current consumption when the Multilogger is turned off:

< 15 μ A

Backing up of date and time in the Multilogger:

< 5 minutes after removing the batteries and with the device turned off

If the Multilogger is without a power for a longer time, the date and time settings in the device could be lost and will have to be set up again. When the Multilogger is connected to an external power supply, the date and time are not lost when batteries are removed.

External power input _____

Power voltage:

+5 V DC (+4.9 V to +5.5 V)

Maximum voltage applied to the power input:

+ 6 V DC max.

Absolute limit above which may be damaged the device!

Current consumption when the Multilogger is turned on:

approximately 200 mA

It is valid when the Ethernet interface is active and the battery charger is turned off.

Current consumption from external power input when the Multilogger is turned off:

approximately 1.5 mA

External power supply connection possibilities:

- Circular power connector 5.5 / 2.1 mm
- +5 V and GND terminals at the RS232 interface
- USB cable

The Multilogger does not allow increase the supply current of the PC USB interface. Therefore the fast battery charging does not have to work correctly from USB.

Battery charger _____

Slow charging mode current:

approximately 10 mA

Fast charging mode current:

approximately 350 mA

Fast charging has to be activated by the Multilogger user. During the fast charging, the Multilogger does not take any measurements nor recording and does not communicate with the computer.

Fast charging time:

Up to 6 hours

Fast charging restriction:

Allowed in ambient temperature from 0 °C to 40 °C.

ALARM OUT output

This output has been designed, for example, for external acoustic signalization or a telephone dialer. The way of its activation can be programmed when configuring the Multilogger. The open connector transistor (OUT), external power voltage (+5 V) and common terminal (GND) are available on the device terminals. The wiring of the output circuits is shown in Appendix 2.

Maximum current of OUT terminal (output switched on):

100 mA

Impedance of switched on output (OUT-GND):

< 1 Ω

Maximum tolerant voltage (OUT-GND, output switched off):

+24 V DC

Supply voltage at +5 V terminal:

+5 V DC from power connector or USB

This voltage is available when the Multilogger is powered from an external power supply only.

Maximum cable length:

30 m, only in interior areas

The external audio unit (*optional accessory MP026*) is designed as wall mounted and it is connected using the CINCH connector (outer lead: OUT, central lead: +5 V).

Communication interfaces

The Multilogger is equipped with USB, Ethernet and RS232C interfaces with automatic detection of a connected cable. Only one of these interfaces can be used for communication at one time. The USB interface has the highest priority (if the Multilogger is connected via its USB port, the other two interfaces are automatically disabled) while the Ethernet interface has the lowest priority (for its proper function, it is necessary that neither the RS232C nor the USB interfaces are connected). The Multilogger does not allow PoE.

RS232C

Communication signals:

RxD, TxD, GND

Galvanic isolation:

Interface is not galvanically isolated

Connector RS232:

Terminal block

Maximum cable length:

15 m, only in interior areas

Baudrate:

115,200 Bd, optionally 230,400 Bd

USB

Compatibility:

USB1.1 and USB 2.0

Connector USB:

mini USB

Vendor ID:

0403

Product ID:

6001

Baudrate:

460,800 Bd

Ethernet

Compatibility:

10/100 MBit Ethernet, galvanically isolated

Connector for Ethernet:

RJ45

Measuring, data memory and real time clock

Measuring interval (except CO₂):

1 s in standard mode (default)
10 s in the energy saving mode

CO₂ measuring interval:

2 minutes in standard mode
10 minutes in the energy saving mode

Recording interval:

1 s, 2 s, 5 s, 10 s, 15 s, 30 s,
1 min, 2 min, 5 min, 10 min, 15 min, 30 min,
1 hour, 2 hours, 3 hours, 4 hours, 6 hours, 12 hours,
24 hours.

Memory capacity:

Up to 1,000,000 values for non-cyclic record
Up to 600,000 values for cyclic record

Duration of data downloading:

< 5 minutes for a 100% data memory occupation using
the USB or Ethernet interface

Real time clock stability:

max. 200 ppm \pm 5 ppm/year at 23 °C \pm 10 °C

Electromagnetic compatibility

The device is tested according to standard EN 61326-1: 2006,
Article 6, Table 1.

Emission:

EN 55011: class B

Immunity:

EN 61000-4-2: class A (4/8 kV)
EN 61000-4-3: class A (3V/m)
EN 61000-4-4: class A (0.5/1 kV)
EN 61000-4-5: class A (external power supply only)
EN 61000-4-6: class A (3 V)

Operation and storage conditions**Operation temperature:**

(-10 to +60) °C

Operation humidity:

(5 to 85) %RH without condensation

Operation environment:

chemically non-aggressive

Storage temperature:

(-30 to +80) °C

Storage humidity:

(5 to 90) %RH

Mechanical characteristics**Dimensions (h x w x d):**

178 x 95 x 37 mm without cables and connectors

Weight:

approximately 380 g, including batteries

Protection:

IP20

Connecting terminal block

two-part, maximum cross-section of the conductor:
1.5 mm²

Included mounting accessories:

MLP001 - wall holder for Multilogger

Optionally mounting accessories:

- MLP002 - lockable wall holder for Multilogger
- MLP003 - magnetic holder for Multilogger
- MLP004 - 18 mm probe holder for Multilogger

Technical parameters of the inputs

The Multilogger is equipped with 4 inputs (connectors) for connecting external probes or signals. Moreover, some models include internal atmospheric pressure sensor and/or a CO₂ air concentration sensor. Connectivity, input ranges and accuracy are determined by connector types which are specific for each model. Required measured quantities can be selected for each input using the *COMET Vision* software. These quantities can be recalculated using two-point linear transformation, displayed, recorded to the memory or used for alarming. In addition, the Multilogger allows creating of calculated quantities from the measured values using simple mathematical operations. The inputs are not galvanically isolated and therefore it is not recommended to connect them to other measuring systems.

The Multilogger allows measure temperature not only in °C, but also in °F. If you use °F, the below stated ranges and accuracy have to be recalculated to °F.

Universal input with a MiniDIN connector

Models equipped with this input:

M1140	Input 1	Input 2	Input 3	Input 4
M1220	Input 1	Input 2		
M1320	Input 1	Input 2		
M1321	Input 1	Input 2		
M1322	Input 1	Input 2		
M1323	Input 1	Input 2		
M1440	Ext. CO ₂ *	Input 2	Input 3	Input 4

* *this input is also equipped with a MiniDIN connector, however, it is not a universal input. It has been **exclusively** designed for connecting an external probe for measuring CO₂ concentration in the air.*

The following devices can be connected to the input with the MiniDIN connector:

- Digi /M digital probe for measuring temperature and humidity.

Measured quantities:

Temperature
Relative humidity

Calculated quantities:

Dew point

For negative temperatures, the Multilogger calculates a dew point, no frost point.

Absolute humidity
Specific humidity
Mixing ratio
Specific enthalpy

Measurement range and accuracy:
According to the connected probe.

Recommended cable length:
maximum of 15 meters

- Pt1000/M intelligent RTD probe for temperature measuring

Measured quantity:

temperature from the RTD sensor
Pt1000/ 3850 according to EN 60751

Range:

(-200 to +600) °C

Accuracy (without probes)

±0.2 °C in the range of (-200 to 100) °C
±0.2 % from the measured value in the range
of (100 to 600) °C

Resolution:

better than 0.01 °C *)

Measuring current:

approximately 0.5 mA within an impulse about
60 ms

Recommended cable length:
maximum of 15 meters

**) to achieve this value, the corresponding number of decimals must be set*

- Custom Pt1000 RTD probe for temperature measuring

The input parameters are identical to the above described Pt1000/M. For these probes, you have to compensate the cable length using the *User calibration* manual settings. The connector wiring is shown in Appendix 4. The manufacturer recommends to preferably use the Pt1000/M intelligent probes.

- External CO₂ probe

Measured quantity:

CO₂ concentration in the air

Input device range (limited by probe connected):
0 to max 65 000 ppm

Accuracy (according to the connected probe, always at 23 °C and 1,013 hPa):

0 to 10 000 ppm probe
± (100 ppm + 5% of the measured value)

0 to 50 000 ppm probe
± (750 ppm + 2% of the measured value)

Cable length:

according to the order 1m, 2m, 4m

This probe can be connected to the input No. 1 of the model M1440 only.

Universal input with a miniature thermocouple connector

The input is equipped with a white, uncompensated miniature thermocouple connector. Compensation of the cold junction temperature is performed by measuring the temperature inside of the device in the area between the input connectors. The inputs are not galvanically isolated from each other, nor from other signals connected to the device. In order to secure correct measurements, you need to prevent undesirable coupling. Furthermore, the Multilogger has to be placed in its working position and temperature stabilized.

Models equipped with this input:

M1200	Input 1	Input 2	Input 3	Input 4
M1220			Input 3	Input 4

The following devices can be connected to this input:

- Thermocouple of the “K” type (NiCr-Ni)
Measured quantity:
temperature
Range:
(-200 to 1,300) °C
Accuracy (without probes)
 \pm (0.3% from the measured value + 1.5 °C)
Resolution:
better than 0.1 °C *)
Cold junction:
compensated in the temperature range of (-10
to 60) °C

**) to achieve this value, the corresponding number of decimals must be set*

- Thermocouple of the “J” type (Fe-Co)
Measured quantity:
temperature
Range:
(-200 to 750) °C
Accuracy (without probes)
 \pm (0.3% from the measured value + 1.5 °C)
Resolution:
better than 0.1 °C *)
Cold junction:
compensated in the temperature range of (-10
to 60) °C

**) to achieve this value, the corresponding number of decimals must be set*

- Thermocouple of the “S” type (Pt10%Rh-Pt)
Measured quantity:
temperature
Range:
(0 to 1,700) °C
Accuracy (without probes)
 \pm (0.3% from the measured value + 1.5 °C)

Resolution:
better than 0.1 °C *)

Cold junction:
compensated in the temperature range of (-10
to 60) °C

*) *to achieve this value, the corresponding number of
decimals must be set*

- Thermocouple of the “B” type (Pt30%Rh-Pt)

Measured quantity:
temperature

Range:
(100 to 1,800) °C

Accuracy (without probes)
 \pm (0.3% from the measured value + 1 °C)
in the range of (300 to 1,800) °C

Resolution:
better than 0.1 °C *)

Cold junction:
uncompensated

*) *to achieve this value, the corresponding number of
decimals must be set*

- Thermocouple of the “T” type (Cu-CuNi)

Measured quantity:
temperature

Range:
(-200 to 400) °C

Accuracy (without probes)
 \pm (0.3% from the measured value of + 1.5 °C)

Resolution:
better than 0.1 °C *)

Cold junction:
compensated in the temperature range of (-10
to 60) °C

*) *to achieve this value, the corresponding number of
decimals must be set*

-
- Thermocouple of the “N” type (NiCrSi-NiSiMg)
Measured quantity:
temperature
Range:
(-200 to 1,300) °C
Accuracy (without probes)
± (0.3% from the measured value of + 1.5 °C)
Resolution:
better than 0.1 °C *)
Cold junction:
compensated in the temperature range of (-10 to 60) °C

*) *to achieve this value, the corresponding number of decimal places must be set.*

- DC voltage from -60 mV to +140 mV

Range:
(-60 to +140) mV
Accuracy:
± 100 µV
Resolution:
better than 1 µV *)

*) *to achieve this value, the corresponding number of decimals must be set*

Input impedance
approximately $10^7 \Omega$
Minimum allowable input voltage:
-0.2 V
Maximum allowable input voltage:
+3 V
Connector:
miniature uncompensated thermocouple connector (white color)

- DC voltage from -18 mV to +18 mV

Range:
(-18 to +18) mV
Accuracy:
± 20 µV

Resolution:
better than 0.5 uV *)

Input impedance
approximately $10^7 \Omega$

Minimum allowable input voltage:
-0.2 V

Maximum allowable input voltage:
+3 V

Connector:
miniature uncompensated thermocouple
connector (white color)

**) to achieve this value, the corresponding number of
decimals must be set*

Universal input with a terminal _____

The input is equipped with two-part removable terminal block with four wires. The inputs are not galvanically isolated from each other, nor from other signals connected to the Multilogger. In order to secure correct measurements, you need to prevent undesirable coupling.

Models equipped with this input:

M1300	Input 1	Input 2	Input 3	Input 4
M1320			Input 3	Input 4
M1321			Input 3	Input 4
M1322			Input 3	Input 4
M1323			Input 3	Input 4

The following signals can be connected to this input:

- DC voltage in the range of 0 to 10 V

Range:

(0 to 10) V DC

Accuracy:

± 10 mV

Resolution:

better than 100 μ V *)

Input impedance

approximately 130 k Ω

Minimum allowable input voltage:

-0.2 V (10 V - COM)

Maximum allowable input voltage:

+30 V (10 V - COM)

Recommended cable length:

maximum of 15 meters, use shielded cables

*) to achieve this value, the corresponding number of decimals must be set

-
- DC current in the range of 0 to 20 mA

Range:

(0 to 20) mA DC

Accuracy:

$\pm 20 \mu\text{A}$

Resolution:

better than $0.1 \mu\text{A}$ *)

Input impedance

approximately 100Ω

Minimum allowable input current:

0 mA (disconnected circuit)

Maximum allowable input current:

limited to approximately 40 mA

Maximum cable length:

maximum of 30 meters, use shielded cables

*) *to achieve this value, the corresponding number of decimals must be set*

The Multilogger does not contains the power supply suitable for passive transmitters with a current loop. This situation has to be resolved by additional power supply source.

- Binary signal - monitoring changes of the binary signal. You can connect a contact, voltage signal or open connector transistor. The binary input can be used on inputs No. 3 and 4 only.

Input voltage for level "switched on":

$< 0.4 \text{ V}$

The binary input will not work correctly if the source has a high impedance at its "switched on" state. The problem can be solved by connecting an external resistor of an impedance of approximately (1 to 10) $k\Omega$ connected in parallel to the input.

Input voltage for level "switched off":

$> 2 \text{ V}$

Minimum input voltage:

0 V

Maximum input voltage:

+30 V DC

Impedance of the “switched on” contact:
< 10 kΩ

Impedance of the “switched off” contact:
> 300 kΩ

Voltage on the disconnected contact:
approximately 3 V

In order to work properly, the device equipped with a “transistor with an open connector” can require a higher voltage than Multilogger is able to supply. Moreover, you should also make sure that the voltage in the “switched on” state is not higher than 0.4 V declared above.

Current through the “switched on” contact.
approximately 40 uA in the impulse

Minimum length of input pulse:
1 s in the standard measuring mode
10 s in the power saving measuring mode

Maximum cable length:
< 30 meters (use shielded cable if longer than 5 m). Use shielded cables in environments with electromagnetic disturbance also.

- Pulses for the counter - you can connect a contact, voltage signal or transistor with an open connector. The counter can be used only on input No.4.

Range of counter:
24 bit (16 777 215), the counter overflow can be allowed.

Maximum input frequency:
200 Hz

Input levels:
the same as the parameters of the binary input.

Other options:
relative counter (number of impulses per measuring interval)

Internal barometric sensor _____

Models equipped with this sensor:

M1321	barometric pressure
M1323	barometric pressure

Parameters:

Measured quantity:

barometric pressure (absolute)

Range:

M1321: 600 hPa to 1,100 hPa

M1323: 700 hPa to 1,100 hPa

Accuracy:

±1.3 hPa at 23 °C

Other options:

recalculation to the sea level

Supported physical quantities:

hPa, kPa, mbar, mmHg, inHg, inH₂O, PSI, oz/in²

Internal CO₂ concentration sensor in the air _____

Models equipped with this sensor:

M1322	CO ₂ concentration in the air
M1323	CO ₂ concentration in the air

Parameters:

Measured quantity:

CO₂ concentration in the air

Range:

0 to 2,000 ppm

Accuracy:

± (50 ppm + 2% of the measured value)
at 23 °C and 1,013 hPa

Appendixes

Appendix 1: Selected error messages

Error	Description and solution
Error 1	The value is out of the input range (low limitation). - shorted Pt1000/M probe - negative input voltage (thermocouples, 0 to 10 V) - reverse input current (for 0 mA to 20 mA range) <i>Check the connected probes and signals!</i>
Error 2	The value is out of the input range (high limitation). - disconnected Pt1000/M probe - too high input voltage (thermocouples, 0 to 10 V) - too high input current (for 0 mA to 20 mA range) <i>Check the connected probes and signals!</i>
Error 4	Digi_/M probe communication error. <i>Check the connected probe - it is probably not connected or it is not Digi_/M line probe!</i>
Error 5	Digi_/M probe communication error. <i>The probe is probably damaged. Try another probe!</i>
Error 7	Pt1000/M probe communication error. <i>Check the connected probe - it is probably not connected or it is not Pt1000/M line probe!</i>
Error 8	Cold junction temperature measurement error. <i>The Multilogger is outside of the range of operational temperatures or the device is damaged.</i>
Error 9	The value is out of the measuring range (for example, temperature from RTD and from the thermocouple probes). <i>The probe could be defective, the thermocouple type could be different and there may be an undesirable coupling among inputs or incorrect calibration of the Multilogger. Try a different probe, check the cables and unwanted coupling.</i>
Error 10	The pressure sensor is not available. <i>Send the Multilogger for repair.</i>
Error 11	The counter does not have valid data, the Multilogger has been without batteries. <i>Erase the counter using the SW and repeat measurement.</i>

Error	Description and solution
Error 12 : Error 16	The CO ₂ concentration sensor is not available or does not work correctly. <i>Send the Multilogger for repair.</i>
Error 19	The source value for the calculated channel is not available. <i>Check calculated channel settings and its source values.</i>
Error 20	Calculation error, incorrectly calibrated device. <i>Send the Multilogger for repair.</i>
Error 21	Counter overflow. <i>Erase the counter using the SW and repeat measurement. If you do not want to be considered the counter overflow as error you can change this setting of the input.</i>
Error 22	Internal voltage error. Undesirable coupling among the inputs, incorrect connection, damaged cables, damaged device. <i>Check the input connections and the connected cables.</i>
Error 50, Error 53 : Error 56	Device configuration error, damaged configuration. <i>Download the configuration to the SW, check of the settings of individual items and save them back to the Multilogger.</i>
Error 51	The probe of the Digi/M line contains invalid calibration constants. <i>Send the probe for repair or contact the manufacturer.</i>
Error 52	The probe of the Pt1000/M line contains invalid calibration constants. <i>Send the probe for repair.</i>
Error 90 Error 91	The Ethernet interface - the measured value is out of numerical range. <i>Verify the measured value on the device display, contact the manufacturer.</i>
Error 128 : Error 255	Communication error. <i>Repeat the communication, contact the manufacturer.</i>

Appendix 2: Output and power supply circuits

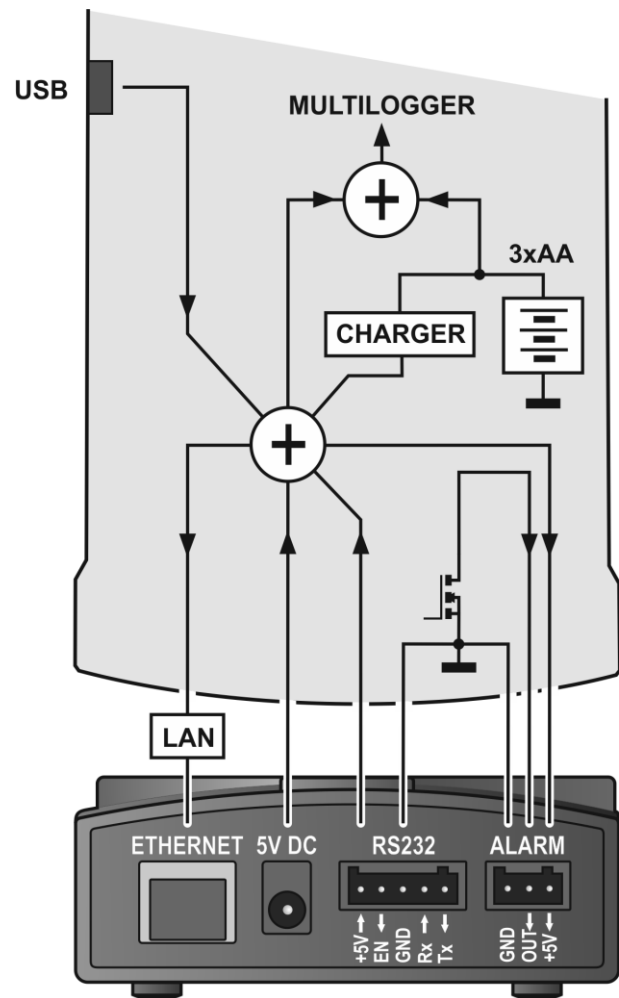

Appendix 3: Input circuits

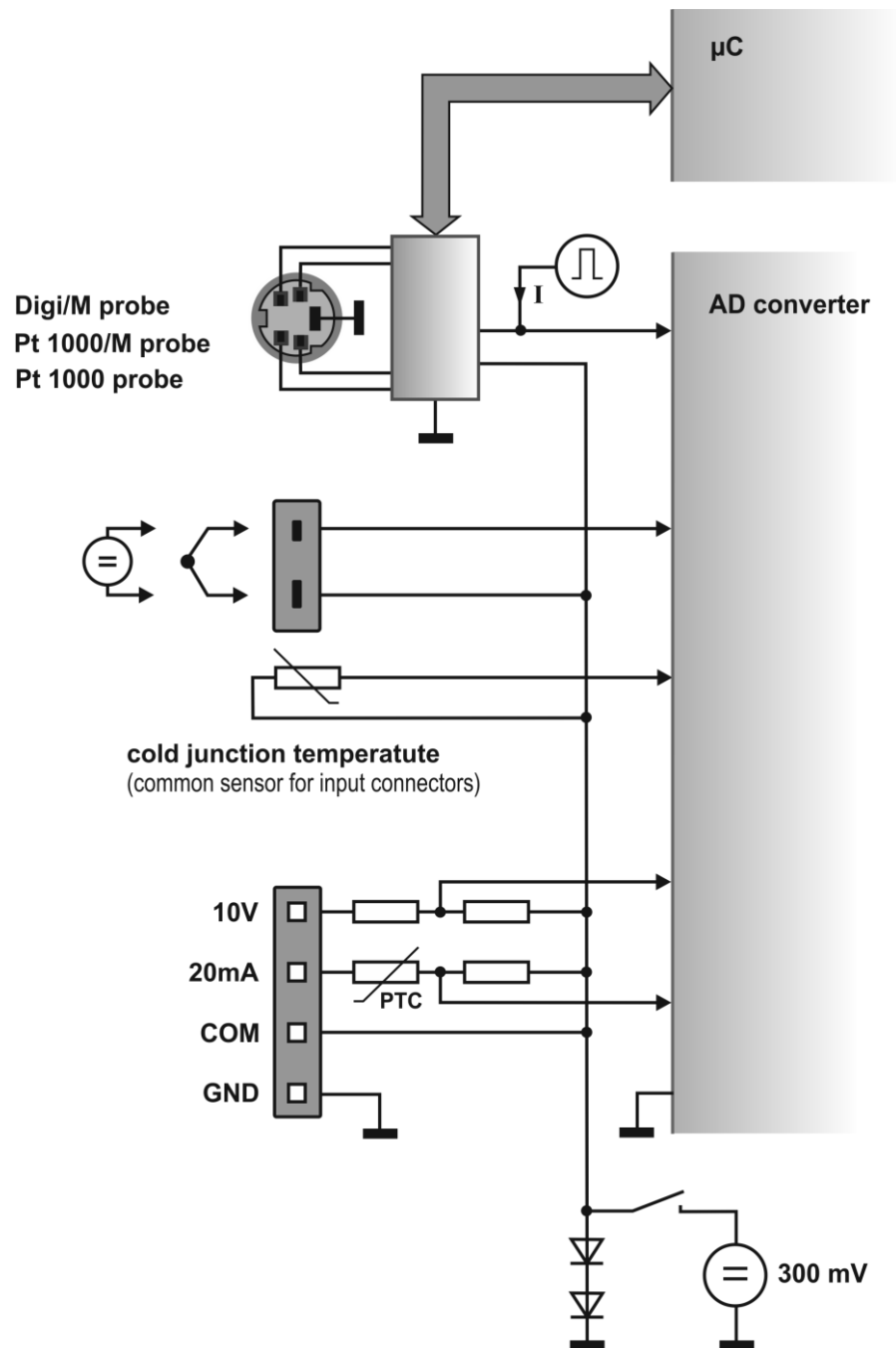

Appendix 4: Connecting of Pt1000 RTD probe

It is recommended to use the intelligent probes Pt1000/M with the Multilogger. This product line includes the memory with probe information and data for automatic correction of the cable impedance. The Pt1000/M probes are interchangeable without need to consider the cable length. May be that the connection of the standardize RTD Pt1000 probe will be necessary. In this case you can connect this probe in accordance with drawing shown below. Use four-pin MiniDIN connector (COMET order code K5411). The input of the Multilogger have to be set to "Custom Pt1000" using the SW (instead of Pt1000/M). For the correction of cable impedance the *User calibration* can be used.

Connecting a Pt1000 temperature probe to the MiniDin connector:

