

STE 2

User Manual

Safety warning

The device meets the requirements of standards valid in the Czech Republic, has undergone live testing and is delivered in operational condition. To maintain the device in this condition, it is necessary to observe the safety and device maintenance requirements set forth below.

If the device is not used in the manner recommended by the manufacturer, the security offered by the device may be breached!

The power socket or point of disconnecting the device from power supply must be freely accessible!

The device must not be used in particular if:

- it is visibly damaged
- it does not work properly
- there are loose parts inside the device
- it was exposed to long-term humidity or got wet
- it underwent unqualified repair by unauthorised personnel
- the power adapter or its supply cable are visibly damaged
- if the device is used in a manner other than the designated manner, the protection provided by the device may be breached
- the switch or fuse and other power surge protection resources must be part of the overall construction unit

The manufacturer is liable for the device only if it is powered by the supplied or approved power source.

Should you have any problems with installation and start-up, you can contact our technical support:

HW group s.r.o.
<http://www.hw-group.com>
email: support@HWg.cz

Rumunská 26/122
Praha 2, 120 00
Tel.+420 222 511 918

Before contacting technical support, prepare the precise model of your device (on the manufacturing label and the firmware version (see below), if you know it.

Contents

Safety warning	2
Contents	3
STE2 – Basic features	4
Basic features	5
Application	5
Wiring the connectors	6
Recommended connection	7
First steps	8
WWW interface	10
<i>Home tab</i>	10
<i>General Setup tab</i>	11
<i>WiFi tab</i>	12
<i>Sensors tab</i>	15
<i>Digital Inputs tab</i>	16
<i>E-mail tab</i>	17
<i>SNMP tab</i>	18
<i>Time tab</i>	20
<i>Portal tab</i>	21
<i>System tab</i>	23
Technical parameters	25
<i>Physical dimensions</i>	26
<i>WiFi Radio</i>	27
<i>WiFi signal strength</i>	27
<i>Impact of device position vis-à-vis the transmitter</i>	28
Supported interfaces	29
<i>Dry contact inputs</i>	29
<i>RJ11 – 1-Wire bus</i>	29
<i>Active / Passive 1-Wire port</i>	30
<i>Sensor Hysteresis</i>	30
Connecting STE2 to the SensDesk portal	31
Using the mobile phone app	36
Firmware upgrade in STE2 units	37
Notes	40

STE2 – Basic features

STE2 is a thermometer with an Ethernet and WiFi interface and option of connection to the SensDesk portal.

STE2 is a device with SNMP support designated for measuring temperature and humidity from external sensors, with the option of connection to the internet via classic cable or WiFi. If the permitted range of values is exceeded, it allows the sending of an alarm via e-mail, via the SensDesk portal or via SMS. Support of monitoring system is a matter of course and the device is supplied with free HWg-PDMS software to create graphs and export data to MS Excel. The packaging includes a power adapter and temperature sensor.



Basic features

- Contains classic Ethernet and WiFi – 802.11 b/g/n (2.4 GHz)
- Support of current Ethernet and WiFi operation (for easy configuration)
- 5V or PoE power supply
- Simple installation, supports DHCP
- Built-in WEB server – no need for any software other than a standard internet browser
- Can be connected to NMS (SNMP MIB)
- Sends an e-mail if the temperature is too high / low
- Support of TLS authorisation (GMAIL)
- Password protected
- Supplied with Windows HWg-PDMS software for drawing graphs and exporting data to MS Excel

Application

A/C outages

Changes in temperature alert you to outages of the A/C cooling unit

Heating monitoring

Remote monitoring of the heating system, alert via e-mail or SMS about the risk of freezing (e-mail-2-SMS)

Monitoring of provided services

Using the provided HWg-PDMS software, you can easily create reports with temperature graphs at one or several locations. You can have an overview of the quality of outsourced services.

Fridge and freezer monitoring

Sends an e-mail to alert you of refrigerator outages. Logging of operation and storage conditions.

Heating optimisation

Cost savings for heating and A/C.

Food storage

Monitors optimal storage conditions. Protocols for HACCP can be created using the application software.

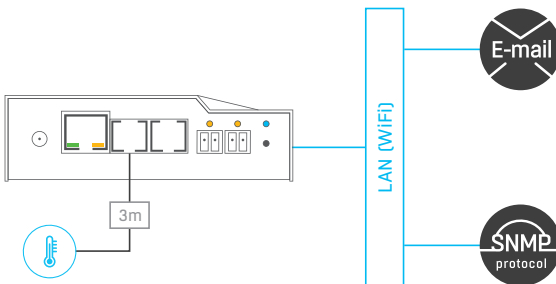

Connectors and wiring

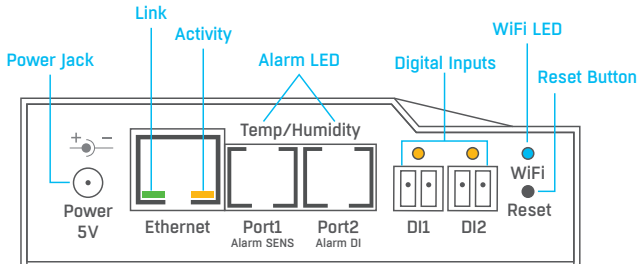

Description of connectors

- **Ethernet** – Serves for internet connection via cable for operation in a classic computer network and for configuration of operation on WiFi. The connector supports power supply from the computer network via PoE.
- **Temp/Humidity** – Serves to connect up to 3 temperature or humidity sensors. The sensor length may be up to 60 metres in each port.
- **Power** – Connector for 5V power supply in the case of power supply from an external adapter.
- **Digital Inputs** – Serves to connect sensors with digital output.

LED diodes on the front panel

- **Link** – A green LED signals connectivity to the computer network.
- **Activity** – A yellow flashing LED signals ongoing communication on the cable connection to the computer network.
- **WiFi** – A blue LED signals establishment of a connection to the WiFi connection point. When establishing a connection, it signals the state by flashing.
- **Alarm LED** – Two LEDs hidden in the Port1 and Port2 connectors. Shining LEDs indicate Alarm state.
 - **Alarm SENS** – Shining LEDs signal Alarm state on one of the temperature or humidity sensors.
 - **Alarm DI** – Shining LEDs signal Alarm state on one of the digital inputs.

Description of button function

- **Reset** – serves to restore factory settings on the device.

1. Switch the device off.
2. Press and hold the button.
3. Switch the device on and press the button for another 5 seconds.
4. All the LEDs will gradually light up.
5. Restart the device. Factory settings will be restored.

Recommended connection

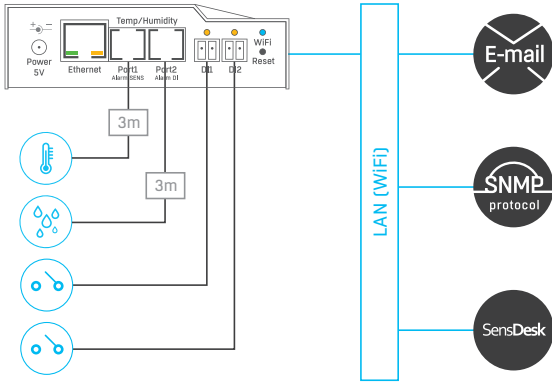

Sensor connection options:

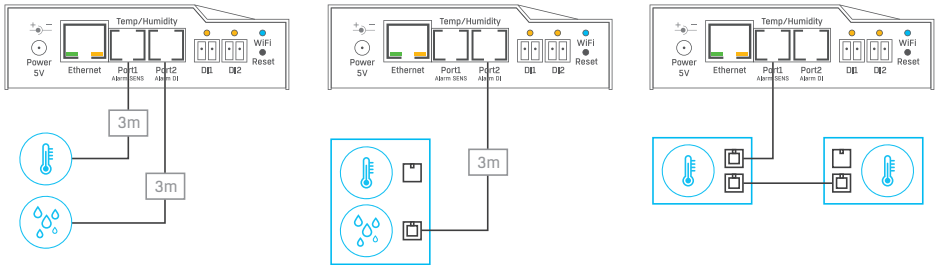

Smoke sensor connection:

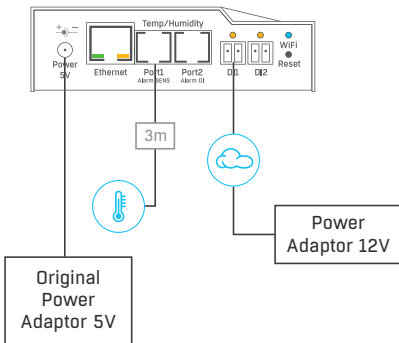

First start-up

First step

1 Cable connection

- Connect STE2 to the **Ethernet** (direct cable to the **switch**, crossed to PC).
- Connect the power adapter to the grid and connect it to the STE2 power supply connector.
- The green LED in the **Power&Mode** RJ45 connector will light up.
- If connection to the **Ethernet**, is functional, the **LINK** (yellow) LED should light up shortly afterwards and switch off during data transfer to the Ethernet (Activity signalisation).
- A quickly flashing yellow **LINK** LED signalises communication with the DHCP server.

2 Setting of the IP address - HWg-Config

The **HWg-Config** program is located in the main director on the enclosed CD (version for Windows and Linux).

The program can be downloaded at www.HW-group.com Software -> HWg-Config.

- Click on the icon to launch the **HWg-Config** program – the program automatically searches for connected devices.
- Launch the search by clicking on the **Find Devices** icon.
- The program searches for devices in your local network. Click on the MAC address of the device to open the dialogue window for device settings.

HWg-Config 1.1.0 for HW group products (www.hw-group.com)

Version: 1.1.0 HW group, s.r.o. www.hw-group.com
Config utility for the HW group devices

Your PC network settings:
IP address: 192.168.100.168
Netmask: 255.255.0.0
Gateway: 192.168.100.1

Find Devices

MAC	Name	* IP	Device type	Port	Parameters
00:0A:59:00:02:95	Damocles MINI	192.168.100.47	Damocles model MINI	80	TCP setup=Y, DHCP=N
00:0A:59:04:00:5E	SH4 server rack	192.168.100.49	SH4serverrack	80	TCP setup=N, DHCP=N
00:0A:59:02:26:02	HWg-SH4e	192.168.100.57	HWg-SH4e	80	TCP setup=N, DHCP=N
00:0A:59:02:26:7F	HWg-SH4e	192.168.100.58	HWg-SH4e	80	TCP setup=N, DHCP=N
00:0A:59:02:26:82	HWg-SH4e	192.168.100.59	HWg-SH4e	80	TCP setup=N, DHCP=N
00:0A:59:04:00:59	HWg-SH4 test2	192.168.100.60	HWg-SH4test2	80	TCP setup=N, DHCP=N
00:0A:59:04:34:E7	STE2	192.168.100.62	STE2 - Eth	80	TCP setup=N, DHCP=N
00:0A:59:04:00:50	HWg-SH4 Hlavni	192.168.100.63	HWg-SH4Hlavni	80	TCP setup=N, DHCP=N
00:0A:59:04:2F:59	Poseidon2 4002 Vitel	192.168.100.81	Poseidon2 model 4002	80	TCP setup=Y, DHCP=N
00:0A:59:04:05:3C	Poseidon2 4002 Derr	192.168.100.90	Poseidon2 model 4002	80	TCP setup=Y, DHCP=N
00:0A:59:04:0E:3D		192.168.100.141	I/O Controller 2	23	TCP setup=Y, TEA=N
00:0A:59:04:0F:48		192.168.100.142	I/O Controller 2	23	TCP setup=Y, TEA=N
00:0A:59:04:33:9D	STE2	192.168.200.2	STE2 - Eth	80	TCP setup=N, DHCP=N
00:0A:59:04:35:2C	STE2	192.168.200.5	STE2 - Eth	80	TCP setup=N, DHCP=N
00:0A:59:04:35:20	STE2	192.168.200.6	STE2 - Eth	80	TCP setup=N, DHCP=N
00:0A:59:04:35:23	STE2	192.168.200.7	STE2 - Eth	80	TCP setup=N, DHCP=N
00:0A:59:04:35:20	STE2	192.168.200.8	STE2 - Eth	80	TCP setup=N, DHCP=N

Searching modules... 277 device(s) found on network, 277 device(s) filtered out Filter: All

First step

Set device network parameters:

- IP address / HTTP port (80 by standard)
- Your network ask
- IP address of your network gateway
- Device name (optional parameter)

Save the settings by clicking on **Apply Changes**.

Restore default settings:

- Right-click on the device MAC address.
The default values from the HWg-Config can be restored by software mode during the first 60 settings after start-up.
- Press the RESET button, hold it down and connect the power source.
Hold the button down for another 5 seconds until all the LEDs light up.

Details

Name: STE2 IP address: 192.168.100.62 [DHCP] Port: 80

Enable DHCP

Open in WEB Browser

Mask: 255.255.255.0 [DHCP] MAC: 00:0A:59:04:34:E7

Gateway: 192.168.100.1 [DHCP] FW version: 0.8.2

Enable IP access filter

Device type: STE2 - Eth (78)

IP filter value: 0.0.0.0 DHCP: Supported

IP filter mask: 0.0.0.0

Default values

Enable NVT

Enable TCP setup

Enable TEA authorisation

Check if new IP address is empty

Load defaults

Cancel Apply changes

Ready

3 Device website

Options of opening the website:

- Enter the device IP address in the browser window.
- Click on the IP address in the HWg-Config program.
- Click on the underlined IP address in the HWg-Config application.

HWg-Config 1.1.0 for HW group products (www.hw-group.com)

Version: 1.1.0 HW group, s.l.o. www.hw-group.com

Config utility for the HW group devices

Your PC network settings: IP address: 192.168. Netmask: 255.255. Gateway: 192.168.

MAC	Name	*IP	Device type	Port	Parameters
00:0A:59:00:D2:95	Dianocles MINI	192.168.100.47	Dianocles model MINI	80	TCP setup-N, DHCP
00:0A:59:04:00:5E	SH4 server rack	192.168.100.49	SH4serverack	80	TCP setup-N, DHCP
00:0A:59:02:26:02	HWg SH4e	192.168.100.52	HWg SH4e	80	TCP setup-N, DHCP
00:0A:59:02:26:7F	HWg SH4e	192.168.100.59	HWg SH4e	80	TCP setup-N, DHCP
00:0A:59:02:26:87	HWg SH4e	192.168.100.59	HWg SH4e	80	TCP setup-N, DHCP
00:0A:59:04:00:59	HWg SH4 test2	192.168.100.60	HWg SH4test2	80	TCP setup-N, DHCP
00:0A:59:04:24:67	STE2	192.168.100.62	STE2 - Eth	80	TCP setup-N, DHCP
00:0A:59:04:00:50	HWg SH4 Hiawes	192.168.100.63	H		HCP
00:0A:59:04:2F:59	Poseidon2 4002 Vtel	192.168.100.61	P		HCP
00:0A:59:04:05:3C	Poseidon2 4002 Dier	192.168.100.50	P		HCP
00:0A:59:04:0E:30		192.168.100.148	M		E&N
00:0A:59:04:0E:46		192.168.100.148	M		E&N
00:0A:59:04:23:90	STE2	192.168.200.2	S		HCP
00:0A:59:04:25:2C	STE2	192.168.200.5	S		HCP
00:0A:59:04:25:20	STE2	192.168.200.6	S		HCP
00:0A:59:04:25:23	STE2	192.168.200.7	S		HCP

Searching modules... 277 device(s) found on network, 277 device(s) filtered out Filter: All

Home tab

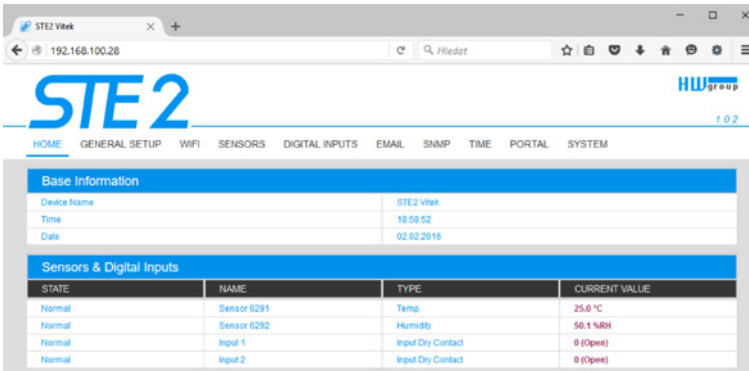

— Base Information section

- **Device Name** – The device name serves to distinguish specific devices in larger installations. Can be set in the General Setup tab.
- **Time** – Current device time. The time can be set automatically from the internet or manually in the Time tab. In the case of automatic setting, the correct value is the indicator of device access to the internet.
- **Date** – Current device date. The date can be set automatically from the internet or manually in the Time tab. In the case of automatic setting, the correct value is the indicator of device access to the internet.

— Sensors & Digital Inputs section

Lists the current values of sensors and digital DI inputs (Dry contacts)

- **State** – Input or sensor state.
 - **Normal** – Idle state, all normal.
 - **Hi Alarm** – Value exceeded the permitted upper limit.
 - **Lo Alarm** – Value dropped below lower bottom limit.
- **Name** – Sensor name for better identification in larger systems. The name can be set in the Sensors or Digital Input tab.
- **Type** – Sensor type; indicates what type of sensor is in question (temperature/humidity/digital input).
- **Current Value** – Current value including unit of measure.

General Setup tab

STE2 Vtek

192.168.100.28/general_setup.xml

HW group

1.0.2

HOME GENERAL SETUP WIFI SENSORS DIGITAL INPUTS EMAIL SNMP TIME PORTAL SYSTEM

Base

NAME	VALUE	DESCRIPTION
Device Name	STE2 Vtek	0 to 32 characters
WWW Info Text	STE2: For more information try www.hw-group.com	
Temperature unit	Celsius	Celsius/Fahrenheit/Kelvin
Periodic restart	Off	Periodic restart time

Network

NAME	VALUE	DESCRIPTION
DHCP	<input checked="" type="checkbox"/>	DHCP Enable/Disable
IP Address	192.168.100.28	A.B.C.D
Network Mask	255.255.255.0	A.B.C.D
Gateway	192.168.100.1	A.B.C.D
DNS Primary	192.168.100.253	A.B.C.D
DNS Secondary	192.168.100.250	A.B.C.D
HTTP Port	80	Default 80

Security: Device Admin

NAME	VALUE	DESCRIPTION
Username		Admin username/password for device configuration changes
Password		[0 to 16 characters]

Save

— Base section

- **Device Name** – Device name (STE2), allow you to distinguish individual STE2 in the network.
- **WWW Info Text** – Text at the foot of the website.
- **Temperature Unit** – Unit for displaying temperature. You can choose between Celsius / Fahrenheit / Kelvin. The Safe Range values will automatically be converted based on this option.
- **Periodic Restart** – Function to improve device stability in exposed networks allowing regular automatic restart of the device.

— Network section

Only the cable connection parameters (RJ-45) are set here. Wireless connection parameters are set in the WiFi tab.

- **DHCP** – Permits the function of IP address setting by the DHCP server, if available. Enabling or disabling DHCP depends on the needs of the user and network administrator.
- **IP Address** – IP address of STE2, allocated by the network administrator.
- **Network Mask** – Network mask, allocated by the network administrator.
- **Gateway** – IP address of the default gateway, allocated by the network administrator.
- **DNS Primary / DNS Secondary** – IP address of the DNS server, allocated by the network administrator.

- **HTTP Port** – Port number on which the built-in WWW server tunes in. A change of the port number is suitable e.g. for multiple STE2 accessible from the external network via a router. Consult the network administrator about potential changes. The default port is 80.

— **Security: Device Admin section**

- **Username / Password** – Username and password to secure access to STE2.

WiFi tab

When WiFi is off, only the enable option is shown:

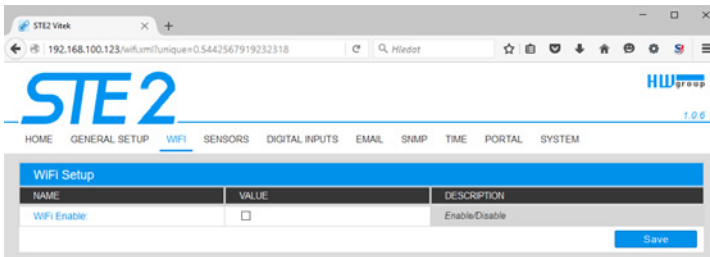

All the options are available after enabling:

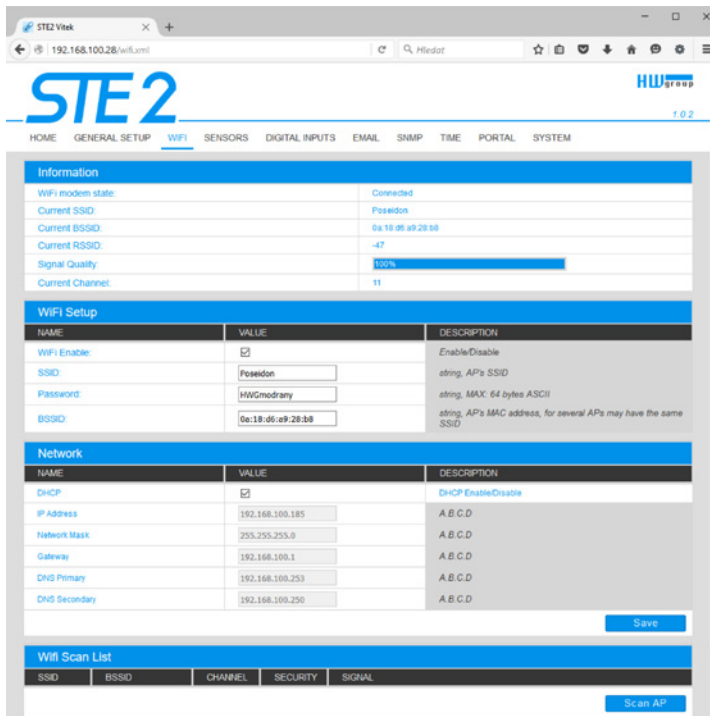

— **WiFi modem state**

- **Disable** - WiFi is disabled.
- **Wait for power on** - Waits for WiFi module when power on.
- **Init** - Initializing of WiFi module.
- **Connecting** - Connecting.
- **SSID check** - SSID check.
- **Connected** - Connected to selected WiFi network.
- **Network WiFi scan** - Scan of available WiFi networks.
- **Wait for scan** - Waits for Network wifi scan.

— **Information section**

- **Current SSID** – Current name of the network to which STE2 is connected. If the parameter is missing, STE2 is not connected to any WiFi network.
- **Current BSSID** – Current identifier of the WiFi network connection point. If the parameter is missing, STE2 is not connected to any WiFi network.
- **Current RSSI** – Relative strength of signal input. The higher the RSSI, the stronger the signal.
- **Signal Quality** – Strength of WiFi signal in % with graphic indicator.
- **Current Channel** – WiFi channel on which STE2 communicates. If the parameter is missing, STE2 is not connected to any WiFi network.

— **WiFi Setup section**

- **WiFi Enable** – Enable or disable WiFi. By standard, the wireless interface is disabled. Device restart follows enabling.
- **SSID** – Name of the WiFi network to which STE2 should be connected. If you do not know your network name, use the Scan AP function at the bottom of the page.
- **Password** – Secured network password. If you do not know it, contact your network administrator.
- **BSSID** – Identifier of the WiFi network connection point (MAC address of the connection point). Optional data.

Network section

WiFi network parameters. Only the wireless interface is set here. Cable Ethernet (RJ-45) is set in the General Setup tab.

- **DHCP** – Permits the function of IP address setting by the DHCP server, if available. Enabling or disabling DHCP depends on the needs of the user and network administrator.
- **IP Address** – IP address of STE2, allocated by the network administrator.
- **Network Mask** – Network mask, allocated by the network administrator.
- **Gateway** – IP address of default gateway, allocated by the network administrator.
- **DNS Primary / DNS Secondary** – IP address of the DNS server, allocated by the network administrator.

WiFi Scan List

- **SSID** – Name of found WiFi network.
- **BSSID** – Connection point identifier (MAC address).
- **Channel** – WiFi channel on which the connection point operates.
- **Security** – Type of secured WiFi communication.
- **Signal** – Signal level in DB. The higher the value, the better. WARNING, -60 is more than -90!
The highlighted row indicates the currently connected AP.

Connecting to found WiFi

- Click on the SSID of the found network to prefill WiFi setting and just enter the Password. The BSSID remains empty. Standard setting. Reconnects automatically if AP is changed.
- Clicking on BSSID will prefill not only the network name (SSID), but also the MAC address of the specific AP (BSSID). STE2 then connects to this AP and will not try to reconnect in the case of aggregated networks.

Scan AP

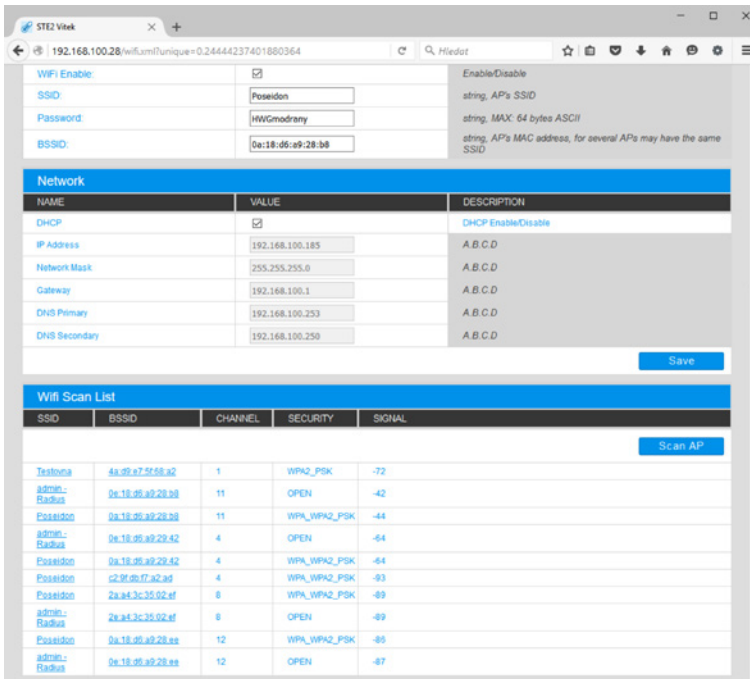

The screenshot shows the STE2 ViteK web interface. The top navigation bar includes the title 'STE2 ViteK' and a search bar with the text 'Hledat'. Below the navigation bar, there are several configuration sections:

- WiFi Enable:** A checkbox that is checked.
- SSID:** A text input field containing 'Poseidon'.
- Password:** A text input field containing 'HWGmodrany'.
- BSSID:** A text input field containing '0a:18:d6:a9:28:b8'.
- Enable/Disable:** A section with three labels: 'Enable/Disable', 'string, AP's SSID', and 'string, MAX: 64 bytes ASCII'.

Below these settings is a **Network** section with a table of configuration items:

NAME	VALUE	DESCRIPTION
DHCP	<input checked="" type="checkbox"/>	DHCP Enable/Disable
IP Address	192.168.100.185	A.B.C.D
Network Mask	255.255.255.0	A.B.C.D
Gateway	192.168.100.1	A.B.C.D
DNS Primary	192.168.100.253	A.B.C.D
DNS Secondary	192.168.100.250	A.B.C.D

A 'Save' button is located at the bottom right of the Network section.

Below the Network section is a **WiFi Scan List** section with a table of scan results:

SSID	BSSID	CHANNEL	SECURITY	SIGNAL
Testovna	4a:d9:e7:5f:08:a2	1	WPA2_PSK	-72
admin_Radius	0a:18:d6:a9:28:b8	11	OPEN	-42
Poseidon	0a:18:d6:a9:28:b8	11	WPA_WPA2_PSK	-44
admin_Radius	0a:18:d6:a9:28:a2	4	OPEN	-64
Poseidon	0a:18:d6:a9:28:a2	4	WPA_WPA2_PSK	-64
Poseidon	c2:0f:0b:17:a2:a9	4	WPA_WPA2_PSK	-93
Poseidon	2a:a4:3c:35:02:ef	8	WPA_WPA2_PSK	-69
admin_Radius	2a:a4:3c:35:02:ef	8	OPEN	-69
Poseidon	0a:18:d6:a9:28:a8	12	WPA_WPA2_PSK	-80
admin_Radius	0a:18:d6:a9:28:a8	12	OPEN	-87

A 'Scan AP' button is located at the bottom right of the WiFi Scan List section.

Sensors tab

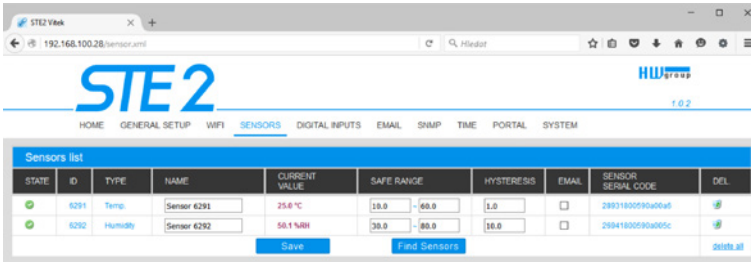

— Sensor List section*

- **State** – Input or sensor state.
 - **Normal** – Idle state, all normal.
 - **Hi Alarm** – Value has exceeded permitted upper limit.
 - **Lo Alarm** – Value has dropped below permitted lower limit.
- **ID** – Sensor ID identical to ID in Poseidon2 and STE2 units.
- **Type** – Sensor type; determine what type of sensor is in question (temperature / humidity / DI input).
- **Name** – Sensor name for better identification in larger systems. The name can be set in the Sensors or Digital Input tab.
- **Current Value** – Current value including unit of measure.
- **Safe Range** – Range of permitted values. If the current value exceeds the Safe Range, an Alarm is activated.
- **Hysteresis** – Defines the insensitivity zone if the limit values are exceeded; prevents the activation of multiple alarms if the temperature oscillates around the limit value.
- **E-mail** – If checked, an e-mail message about the start or end of Alarm state is sent.
- **Code** – Full ID of the 1-Wire sensor.
- **Del.** – Button to delete the specific sensor.

* Sensors in Alarm state are highlighted.

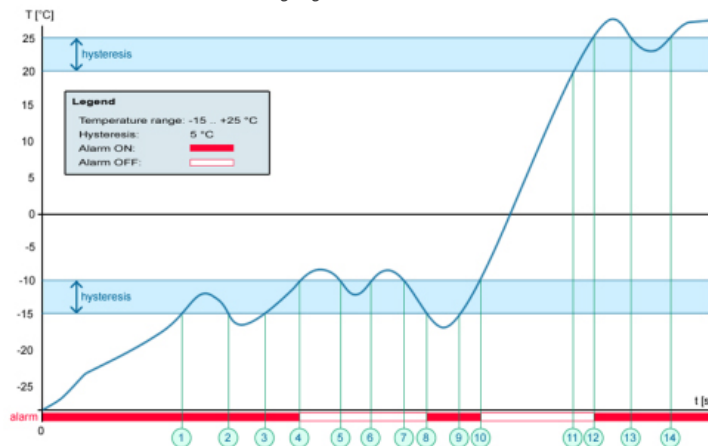

Digital Inputs tab

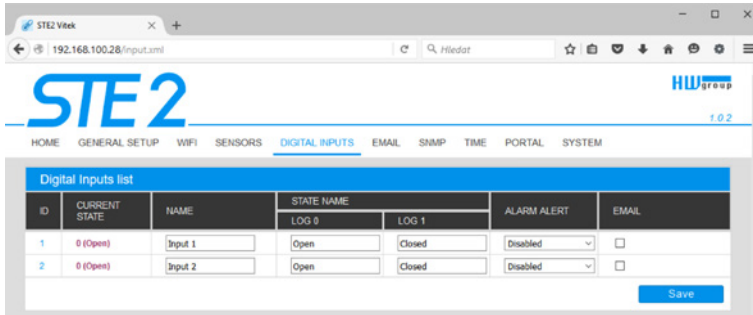

— Sensor List section*

- **ID** – Indication of the input variable within the device.
- **Current State** – List of current input state ("0 (Off)" / "1 (On)").
- **Name** – Input name in 12 characters (e.g. "2F left door", "smoke section 1").
- **E-mail** – If checked, an e-mail message about the start or end of Alarm state is sent.
- **Alarm Alert** – Definition of Alarm state for each input.
- **Active if On** – Alarm active if the input is in state 1 (On).
- **Active if Off** – Alarm active in input is in state 0 (Off).
- **Disabled** – Input does not have a defined Alarm state.

* DI inputs in Alarm state are highlighted.

E-mail tab

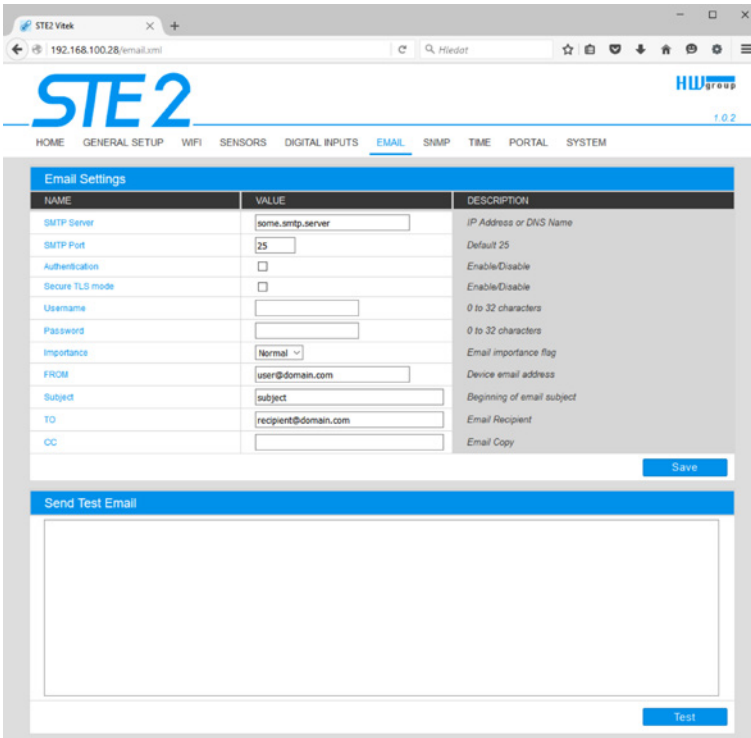

— E-mail Settings

- **SMTP Server** – IP address or domain address of the SMTP server.
- **SMTP Port** – Port number on which the e-mail server tunes in – 25 by standard.
- **Authentication** – Enable authentication; check if the SMTP server requires authentication.
- **Secure TLS mode** – Check if the SMTP server requires secure communication via SSL/TLS.
- **Username** – Username for SMTP server authentication. If the Authentication field is not checked, the content of this field is irrelevant.
- **Password** – Password for SMTP server authentication. If the Authentication field is not checked, the content of this field is irrelevant.
- **Importance** – Sets priority of the e-mail message. Important for filtering and further processing of alarm messages.
- **FROM** – Sender's e-mail address, i.e. of the STE2 unit. The address may be required by the SMTP servers and can be used to identify the STE2 unit or to filter and further process alarm messages.
- **Subject of e-mail** – The field content can be used to identify the STE2 unit, or for filtering and further processing of alarm messages.

- **TO** – E-mail address to which the alarm e-mail should be sent. Only one e-mail address can be entered.
- **CC** – E-mail address to which a copy of the alarm e-mail should be sent. Only one e-mail address can be entered.

The TO and CC fields do not allow the entry of several e-mail addresses or distribution lists. If the e-mail should be sent to several addresses, it is necessary to agree with the SMTP server administrator on the creation of a distribution list under one e-mail address.

— Send Test E-mail section

The button serves to send a test e-mail to set E-mail Settings.

After sending the test e-mail, the sending protocol will be transcribed in the text field.

SNMP tab

The SNMP tab sets the parameters for communication via SNMP protocol.

General SNMP Settings

System Name: STE2 (0 to 32 characters)

System Location: (0 to 32 characters)

System Contact: STE2: For more information try <http://www.hw-group.com>

SNMP port: 161 (Default port 161)

SNMP Access

COMMUNITY	READ	WRITE	ENABLE
public	<input checked="" type="checkbox"/>	<input type="checkbox"/>	<input checked="" type="checkbox"/>
private	<input checked="" type="checkbox"/>	<input checked="" type="checkbox"/>	<input checked="" type="checkbox"/>

[Show OID hex table](#)

Save

— General SNMP Settings section

- **System Name** – Device name within SNMP.
- **System Location** – Device location within SNMP.
- **System Contact** – Contact of STE2 administrator within SNMP.
- **SNMP port** – Port number on which communication via SNMP is possible – 161 by standard.

— SNMP Access section

- **Community** – Name of SNMP community for access to STE2 via SNMP. 2 communities can be defined. For each Community you can define whether it has rights for:
 - **Read**
 - **Write**

Show OID keys table

This function writes up the entire tree of variables with indication of the entire SNMP OID and explanations of the type of variable. For connecting STE2 to third-party monitoring systems, there is also an MIC file under the Download MIB file link.

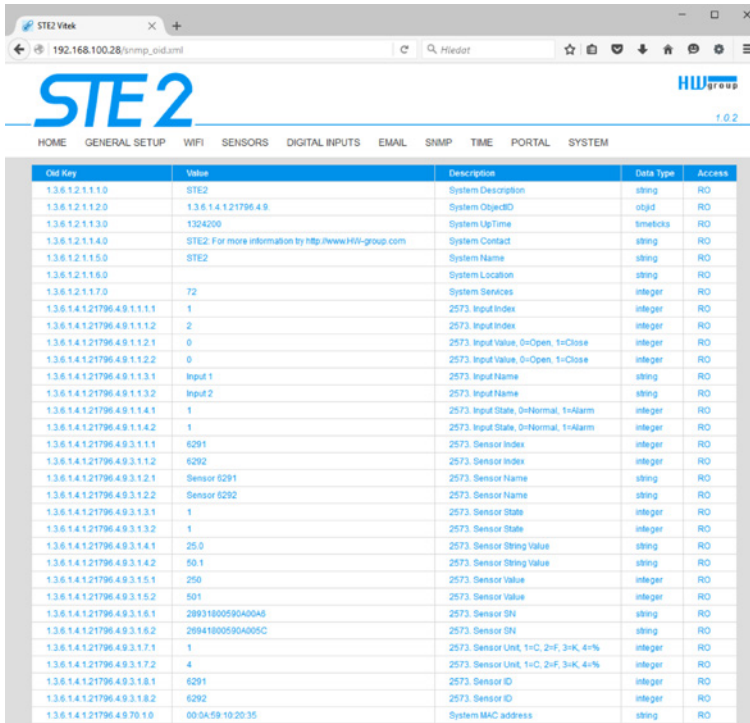

Old Key	Value	Description	Data Type	Access
1.3.6.1.2.1.1.0	STE2	System Description	string	RO
1.3.6.1.2.1.2.0	1.3.6.1.4.1.21796.4.9	System ObjectID	oidId	RO
1.3.6.1.2.1.3.0	1324200	System UpTime	timeTicks	RO
1.3.6.1.2.1.4.0	STE2: For more information by http://www.HW-group.com	System Contact	string	RO
1.3.6.1.2.1.5.0	STE2	System Name	string	RO
1.3.6.1.2.1.6.0		System Location	string	RO
1.3.6.1.2.1.7.0	72	System Services	integer	RO
1.3.6.1.4.1.21796.4.9.1.1.1.1	1	2573. Input Index	integer	RO
1.3.6.1.4.1.21796.4.9.1.1.1.2	2	2573. Input Index	integer	RO
1.3.6.1.4.1.21796.4.9.1.1.2.1	0	2573. Input Value, 0=Open, 1=Close	integer	RO
1.3.6.1.4.1.21796.4.9.1.1.2.2	0	2573. Input Value, 0=Open, 1=Close	integer	RO
1.3.6.1.4.1.21796.4.9.1.1.3.1	Input 1	2573. Input Name	string	RO
1.3.6.1.4.1.21796.4.9.1.1.3.2	Input 2	2573. Input Name	string	RO
1.3.6.1.4.1.21796.4.9.1.1.4.1	1	2573. Input State, 0=Normal, 1=Alarm	integer	RO
1.3.6.1.4.1.21796.4.9.1.1.4.2	1	2573. Input State, 0=Normal, 1=Alarm	integer	RO
1.3.6.1.4.1.21796.4.9.3.1.1.1	6291	2573. Sensor Index	integer	RO
1.3.6.1.4.1.21796.4.9.3.1.1.2	6292	2573. Sensor Index	integer	RO
1.3.6.1.4.1.21796.4.9.3.1.2.1	Sensor 6291	2573. Sensor Name	string	RO
1.3.6.1.4.1.21796.4.9.3.1.2.2	Sensor 6292	2573. Sensor Name	string	RO
1.3.6.1.4.1.21796.4.9.3.1.3.1	1	2573. Sensor State	integer	RO
1.3.6.1.4.1.21796.4.9.3.1.3.2	1	2573. Sensor State	integer	RO
1.3.6.1.4.1.21796.4.9.3.1.4.1	25.0	2573. Sensor String Value	string	RO
1.3.6.1.4.1.21796.4.9.3.1.4.2	50.1	2573. Sensor String Value	string	RO
1.3.6.1.4.1.21796.4.9.3.1.5.1	250	2573. Sensor Value	integer	RO
1.3.6.1.4.1.21796.4.9.3.1.5.2	501	2573. Sensor Value	integer	RO
1.3.6.1.4.1.21796.4.9.3.1.6.1	289318000590A00A6	2573. Sensor SN	string	RO
1.3.6.1.4.1.21796.4.9.3.1.6.2	289418000590A005C	2573. Sensor SN	string	RO
1.3.6.1.4.1.21796.4.9.3.1.7.1	1	2573. Sensor Unit, 1=C, 2=F, 3=K, 4=%	integer	RO
1.3.6.1.4.1.21796.4.9.3.1.7.2	4	2573. Sensor Unit, 1=C, 2=F, 3=K, 4=%	integer	RO
1.3.6.1.4.1.21796.4.9.3.1.8.1	6291	2573. Sensor ID	integer	RO
1.3.6.1.4.1.21796.4.9.3.1.8.2	6292	2573. Sensor ID	integer	RO
1.3.6.1.4.1.21796.4.9.70.1.0	00:0A:59:10:20:35	System MAC address	string	RO

Time tab

The system time and parameters of optional automatic synchronisation via time servers is sent in the Time tab.

The screenshot shows a web browser window with the URL `192.168.100.28/sntp.xml`. The page title is "STE2" and the logo "HW group" is visible in the top right. The navigation menu includes: HOME, GENERAL SETUP, WIFI, SENSORS, DIGITAL INPUTS, EMAIL, SNMP, TIME (selected), PORTAL, SYSTEM. The main content area is divided into three sections:

- SNTP Setup**:
 - SNTP Server: IP Address or DNS Name
 - Time Zone: Number -12... +13
 - Summertime: last Sun Mar 2 00 - last Sun Oct 2 00
 - Interval: Sync period: 06/1h/24h
 -
- Time Setup**:
 - Time: hh:mm:ss
 - Date: DD.MM.YYYY
 -
- SNTP synchronize**:
 -

— **SNTP Setup section**

- **SNTP Server** – IP address or domain address of the time synchronisation server; default time.nist.gov.
- **Time Zone** – Setting of the time zone based on STE2 location. Serves to set the correct system time. Required for correct recording of measured values.
- **Summertime** – Enable summer time. Serves to set the correct system time. Required for correct recording of measured values.
- **Interval** – Interval of time synchronisation with the server.

— **Time Setup section**

The Time Setup section enables filling in the current date and time manually, if synchronisation with the time server cannot be used.

— **SNTP synchronisation section**

The Sync button serves to perform instant synchronisation with the time server. It can also be used to test settings.

Portal tab

he tab serves to set parameters for sending data to a remote portal via HWg-PUSH protocol. More about the protocol or support of portal solutions is available on the website <http://www.HW-group.com>.

The screenshot shows the STE2 web interface for the 'Portal' tab. The browser address bar shows '192.168.100.28/portal.html'. The page has a navigation menu with 'PORTAL' selected. The main content area is divided into several sections:

- Portal Message:** A yellow banner with the text 'SensDesk.com - Check sensor online.'
- Portal Config:** A table with columns 'NAME', 'VALUE', and 'DESCRIPTION'. It contains fields for 'Portal' (checkbox), 'Server Address' (text input: 'http://sensdesk.com/portal.php'), 'IP Port' (text input: '80'), 'Username' (password input), and 'PUSH Password' (password input). Descriptions include 'Portal Enable/Disable', 'IP Address or DNS Name', 'Default 80', and 'Push device access parameters see at [My account](#) on SensDesk'.
- Input(s) AutoPush config:** A table with columns 'ID', 'NAME', 'CURRENT VALUE', and 'AUTO PUSH'. It lists two inputs: 'Input 1' and 'Input 2', both with a current value of '0 (Open)' and an 'AUTO PUSH' checkbox.
- Sensor(s) AutoPush config:** A table with columns for sensor ID, name, current value, and a value input field. It lists 'Sensor 6291' (25.0 °C) and 'Sensor 6292' (50.1 %RH). A 'Save' button is at the bottom right.
- Portal Debug:** A table with columns for parameter name, value, and unit. It lists 'Push Period: 300 [s]', 'Log Period: 300 [s]', 'Current Push Timer: 190 [s]', 'Current Log Timer: 240 [s]', and 'AutoPush Block Timer: 0 [s]'. A 'Manual Push' button is at the bottom right.

— Portal Message section

Feedback from the portal containing e.g. links to graphs, etc. Depends on the portal type.

— Portal Config section

- **Portal** – Enables or disables this function
- **Server address** – Complete URL of the remote server. Connection to the www.SensDesk.com is pre-set in the device.
- **IP Port** – Port which the portal tunes in to.
- **Username** – Username for allocation of STE2 to the user. Obtained from the portal administrator.
- **PUSH Password** – Password for allocation of STE2 to the user. Obtained from the portal administrator.

— *Input(s) AutoPush config section*

Sets the behaviour of AutoPush for DI inputs. During activation, the sending of information about changes in the input state to the portal is accelerated. The function can be enabled individually for each input.

Sensor(s) AutoPush config

Sets the behaviour of the AutoPush function for individual sensors. The function accelerates the sending of information about fluctuating values to the portal. When the measured sensor value changes since last communication with the portal by more than the defined value, the device connects to the portal again and sends the new value.

— *Information section*

For debug purposes only.

Push Period – Period of sending data to the remote portal. The period is determined by the portal and cannot be changed by the user.

Log Period – Period of storing data for the portal in the cache. The period is determined by the portal and cannot be changed by the user.

Current Push Timer – Timer indicating the time remaining until sending data to the portal.

Current Log Timer – Timer indicating the time remaining until saving the data for the portal in the cache.

AutoPush Block Timer – Time of incidents for AutoPush. If the permitted number of incidents for one Push period is exceeded, the AutoPush function will be blocked.

— *Portal Debug section*

Debug window for sending data to the portal.

Manual Push – Button for instant sending of data to the portal.

What is AutoPush

AutoPush – By standard, the STE2 thermometer sends data to the portal at a fixed interval defined by the relevant portal (in the case of the SensDesk portal, once every 15 minutes) and the user cannot change this value. A special case is the start and end of Alarms, when extraordinary sending will occur. AutoPush serves for the extraordinary sending of values also whenever the sensor value changes by more than the defined AutoPush value.

This concerns only the setting of communication between STE2 and the online portal. The values of local alarms are set in the portal.

System tab

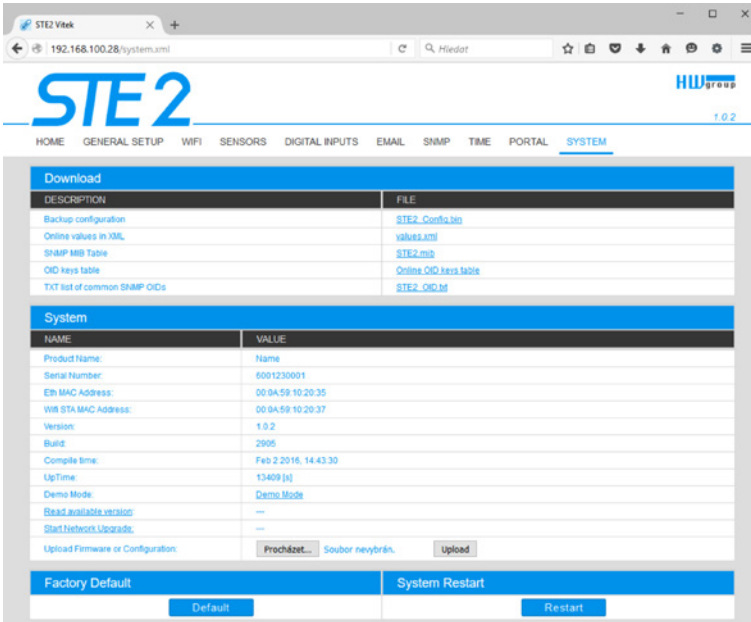

— Download section

- **Backup configuration** – Configuration backup in BIN format. Click on the link to save the current STE2 configuration after its final settings for potential restore purposes.
- **Online values in XML** – Current values in XML format. Click on the link to save the current STE2 configuration after its final settings for potential restore purposes.
- **SNMP MIB Table** – SNMP MIB file. MIB file address containing the definition of SNMP variables.
- **OID keys table** – The function will draw up the entire tree of variables with indication of the entire SNMP OID and explanations of the variable type.
- **TXT list of common SNMP OIDs** – Overview of most important OID from the MIB table.

— System section

Product Name – Device name (type).

Serial Number – Device serial number.

Eth MAC Address – MAC address of device for cable connection.

WiFi STA MAC Address – MAC address of device for WiFi connection.

Version – Firmware version. Serves for diagnostic purposes when solving problems.

Build – Serves for diagnostic purposes when solving problems.

Compile time – Firmware compile time. Serves for diagnostic purposes when solving problems.

UpTime – Runtime of the device since last switching on or restart. Serves for diagnostic purposes when solving problems.

Demo mode – Active demo mode prevents any changes in your device configuration.

In this mode, users can browse and view all the web interface pages, but they are not allowed to change any values. A device with this setting can be placed on the public internet with no risk of changes in its configuration.

Read available version – Lists the latest version of firmware on the HW group update server.

Start Network Upgrade – Launches a firmware upgrade from the HW group update server.

Upload Firmware or Configuration – Install newer firmware or configuration files to the device.

Restore configuration may not work if there is too large a difference in firmware versions.

— Factory Default section

Restores factory settings. The default IP address is 192.168.10.20 and the username and password are not defined.

— System Restart section

Restarts the device.

Technical parameters

Ethernet	
Interface	RJ45 (10/100BASE-T)
Supported protocols	IP: ARP, TCP/IP (HTTP, SMTP, HWg-Push, netGSM, TLS), UDP/IP (SNMP)
SNMP	Version 1 fully supported, some parts version 2

WiFi	
Supported standards	802.11 b/g/n
Frequency	2,4GHz
Output	+19.5 dBm output power in 802.11b mode +16 dBm for 802.11n
Security	WEP / WPA / WPA2 PSK / WPA2 TSK / WPS
Antenna	Internal

External sensors	
Port / connector	Port1, Port2 / RJ11 (1-Wire)
Connectability	Three external temperature or humidity sensors. One combined temperature + humidity sensor can be connected.
Sensor type	Only sensors from HW group s.r.o.
Sensors / distance	Max 3 sensors / Max 60 metres total length

DI INPUTS (Dry Contact Inputs)	
Port / connector	I1, I2 / Ø 2 mm bracket
Type	Digital Input (supports NO/NC Dry contact)
Sensitivity	1 (On) = 0-500 Ohm (Right pin on the terminal block can be connected to 12V GND)
Max. distance	Up to 50m

Power supply	
Power voltage	5V / 250 mA
Connector	Jack Ø3.5 x 1.35 / 10 [mm]
PoE (Power over Ethernet)	RJ45 - IEEE 802.3af Class 0

LED	
LINK	Green – Ethernet connection state
Activity	Yellow – Ethernet activity
Alarm	Port 1 – Alarm SENS – Shines if alarm active on sensor Port 2 – Alarm DI – Shines if alarm active on sensor
IN	Yellow – activation of the contact
WiFi	Blue – connection state in operation (shining), search indicator (flashing slowly) and connection (flashing quickly)

Button	
Reset	Restore default settings: hold or 5 seconds after connecting power supply.

Other parameters	
Operating temperature	-10 to 60 °C (range of device operating temperatures – may not correspond to sensor range)
Dimensions/weight	65 x 80 x 30 [mm] / 500 g
Elmag. radiation	CE / FCC Part 15, Class B
Elmag. compatibility	EN 55022, EN 55024, EN 61000

Physical dimensions

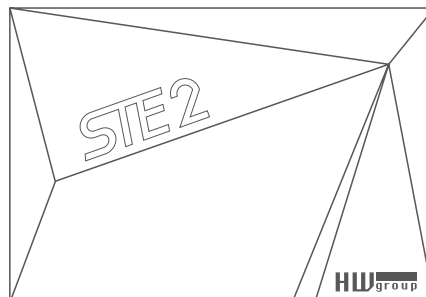
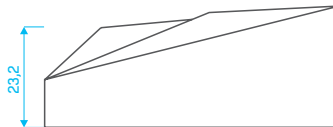
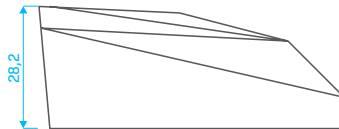
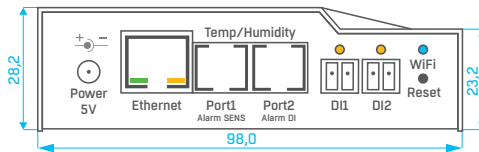
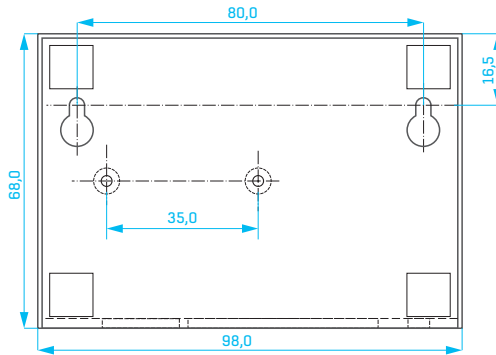

WiFi Radio

Description	Min	Typical	Max	Unit
Input frequency	2412		2484	MHz
Input reflection			-10	dB
Output power of PA for 72.2 Mbps	14	15	16	dBm
Output power of PA for 11b mode	17,5	18,5	19,5	dBm
Sensitivity				
CCK, 1Mbps		-98		dBm
CCK, 11Mbps		-91		dBm
6Mbps (1/2 BPSK)		-93		dBm
54Mbps (3/4 64-QAM)		-75		dBm
HT20, MCS7 (65Mbps, 72.2Mbps)		-71		dBm
Adjacent Channel Rejection				
OFDM, 6Mbps		37		dB
OFDM, 54Mbps		21		dB
HT20, MCS0		37		dB
HT20, MCS7		20		dB

WiFi signal strength

What is signals strength

WiFi is a radio signal and it has limitations in reach given firstly by the transmission output and by the quality and shape of the antennas. Signal strength is indicated in decibels per miliwatt of output (dBm), often (incorrectly) simplified to “dB”. Signal strength has a negative value and it applies that the lower the value (a higher number after the negative sign), the worse.

The decibel unit is non-dimensional and expresses the logarithm of a ratio of two values. In our case, it is the ratio of received output to an etalon of 1 mW:

$$dBm = 10 * \log_{10} \frac{P_1}{1 \text{ mW}}$$

This means that if you have a signal of -54 dbm, it is higher (better) than a value of -82 dbm.

Impact of device position vis-à-vis the transmitter (router or AP)

The STE2 uses a flat antenna similar to mobile telephones or laptops, while the connection points generally use multi-directional antennas (rods). Flat antennas have the same or better sensitivity as multi-directional antennas (the transition connector is omitted), but its primary disadvantages include sensitivity to the positioning of the device vis-à-vis the connection point.

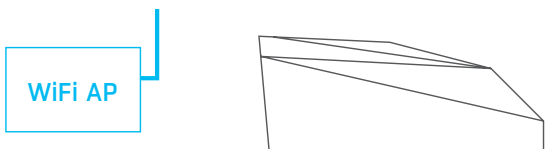
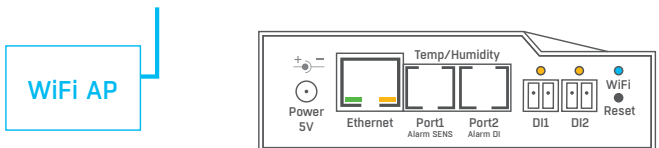
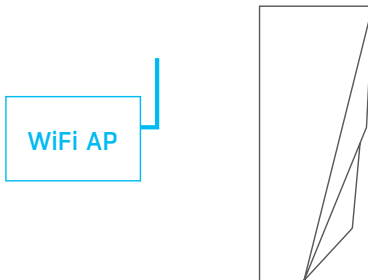
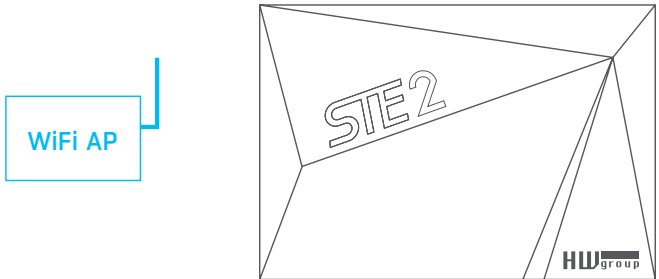

Supported interfaces

Dry contact Inputs

Dry contacts can be connected to the brackets.
For instance door contacts.

The inputs are galvanically connected to the power supply.



- **Unconnected input** has a value of „**0 (Off)**“.
- **Active input** is identified as „**1 (On)**“, Ohmic resistance of the input against the Common bracket must range between 0 Ω and 500 Ω .

Connection parameters:

- **Maximum cable length:** 50 metres.
- **Supported sensors:** Any dry contact.
- **Alarm setting for each DI input**
 - Alarm inactive.
 - Alarm state when the contact is activated or deactivated.
 - Alarm state when the contact is deactivated.
- **Options for reacting to Alarm state:** Common settings for all inputs.
 - No reaction.
 - Notify of Alarm by sending SNMP Trap.
 - Notify of Alarm by sending e-mail or SMS.
 - Notify of Alarm by sending SNMP Trap and e-mail or SMS.
- **Reading period:** 800 ms.
- **Range of ID sensors:** Inputs use address ID in the range of 1 to 9.
- **Sensor name:** The sensor can be named independently with up to 12 characters.
- **Sensor disconnection detection:** No, the disconnected sensor returns to the value „**0 (Off)**“.

RJ11 – 1-Wire bus

Digital bus by Dallas Semiconductor, each sensor has a unique ID

We recommend lines up to a total length of 60 m.
There are known cases of experimentation with bus function up to a distance of tens to hundreds of metres.

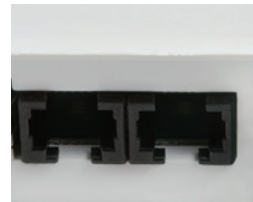

Flawless functioning cannot be guarantee for cables lines than 60 m from one connector on the STE2 unit. It depends on the make of the cable, topology of the line and environment where the line is installed.

Active / Passive 1-Wire port

- **Active port:** RJ11 connector on the STE2 device.
It guarantees full maximum distance of the sensors and power supply for all sensors.

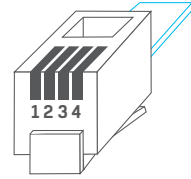

When you reconnected the connected sensor from one active port to another, the sensor shows up as disconnected. You must restart automatic sensor detection.

- **Passive port:** RJ11 connector on the T-Hub router or RJ11 connector from the sensor (if sensors are chained).

RJ11		
1	-	Not used
2	Data	Transmit Data
3	GND	Ground
4	+5V	Power

Sensor Hysteresis

The Hysteresis value defines the width of the tolerance range for sending an alarm. The function prevents the occurrence of multiple alarms in cases when the value oscillates around the defined value. The function is apparent from the graph.

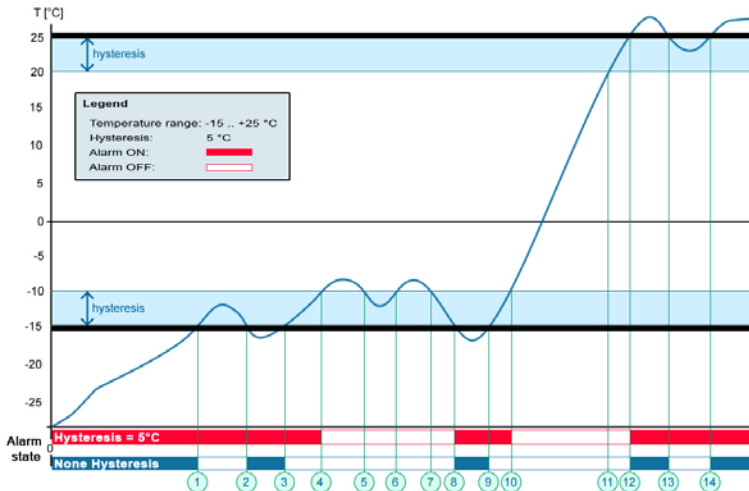

Within the internal 5°C hysteresis band, the alarm would be activated in **point 8** and would end in **point 9**. Because of the hysteresis function, the alarm is extended until the temperature reaches the end of the hysteresis zone (point 10) $5\text{ °C} + (-15\text{ °C}) = -10\text{ °C}$.

- **Hysteresis (=5 °C):** The unit sends **3** e-mails (**SMS**)
Alarm at points **0..4, 8..10, 12** and upwards.
- **Without hysteresis (0 °C):** The unit sends **8** e-mails (**SMS**)
Alarm at points **0..1, 2..3, 8..9, 12..13, 14** and upwards.

Connecting STE2 to the SensDesk portal

- 1 Connect the device to the computer network and set the network parameters (see the **First Steps** chapter).

HWg-Config 1.1.1 for HW group products (www.hw-group.com)

Your PC network settings
IP address: 192.168.200.4
Netmask: 255.255.252.0
Gateway: 192.168.200.1

Device list:

MAC	Name	*IP	Device type	Port	Parameters
00.0A.59.04.33.8E	STE2	192.168.200.41	STE2 - Eth	80	TCP setup=N, DHCP=Y
00.0A.59.04.34.69	STE2	192.168.100.51	STE2 - Eth	80	TCP setup=N, DHCP=Y
00.0A.59.04.33.A3	STE2	192.168.100.79	STE2 - Eth	80	TCP setup=N, DHCP=Y
00.0A.59.04.3A.15	STE2	192.168.100.123	STE2 - Eth	80	TCP setup=N, DHCP=N
00.0A.59.04.33.90	STE2	192.168.200.2	STE2 - Eth	80	TCP setup=N, DHCP=Y
00.0A.59.04.35.2C	STE2	192.168.200.5	STE2 - Eth	80	TCP setup=N, DHCP=Y
00.0A.59.04.35.20	STE2	192.168.200.6	STE2 - Eth	80	TCP setup=N, DHCP=Y
00.0A.59.04.35.23	STE2	192.168.200.7	STE2 - Eth	80	TCP setup=N, DHCP=Y
00.0A.59.04.35.29	STE2	192.168.200.8	STE2 - Eth	80	TCP setup=N, DHCP=Y
00.0A.59.04.35.1A	STE2	192.168.200.9	STE2 - Eth	80	TCP setup=N, DHCP=Y
00.0A.59.04.35.14	STE2	192.168.200.10	STE2 - Eth	80	TCP setup=N, DHCP=Y
00.0A.59.04.35.05	STE2	192.168.200.11	STE2 - Eth	80	TCP setup=N, DHCP=Y
00.0A.59.04.35.38	STE2	192.168.200.12	STE2 - Eth	80	TCP setup=N, DHCP=Y
00.0A.59.04.35.32	STE2	192.168.200.13	STE2 - Eth	80	TCP setup=N, DHCP=Y
00.0A.59.04.33.0C	STE2	192.168.200.14	STE2 - Eth	80	TCP setup=N, DHCP=Y
00.0A.59.04.32.F4	STE2	192.168.200.15	STE2 - Eth	80	TCP setup=N, DHCP=Y
00.0A.59.04.33.09	STE2	192.168.200.16	STE2 - Eth	80	TCP setup=N, DHCP=Y
00.0A.59.04.32.EE	STE2	192.168.200.17	STE2 - Eth	80	TCP setup=N, DHCP=Y
00.0A.59.04.33.A6	STE2	192.168.200.18	STE2 - Eth	80	TCP setup=N, DHCP=Y
00.0A.59.04.34.E0	STE2	192.168.200.20	STE2 - Eth	80	TCP setup=N, DHCP=Y
00.0A.59.04.34.E4	STE2	192.168.200.21	STE2 - Eth	80	TCP setup=N, DHCP=Y
00.0A.59.04.34.D8	STE2	192.168.200.22	STE2 - Eth	80	TCP setup=N, DHCP=Y

Searching modules... 233 device(s) found on network, 130 device(s) filtered and displayed Filter: STE2 - Eth

- 2 Check the device website:

Startovní stránka aplikace ... x STE2 Vitek x +

192.168.100.28/home.xml

STE2

HWgroup 1.0.2

HOME GENERAL SETUP WIFI SENSORS DIGITAL INPUTS EMAIL SNMP TIME PORTAL SYSTEM

Base Information

Device Name	STE2 Vitek
Time	13:42:25
Date	05.02.2016

Sensors & Digital Inputs

STATE	NAME	TYPE	CURRENT VALUE
Normal	Sensor 6291	Temp.	25.0 °C
Normal	Sensor 6292	Humidity	50.1 %RH
Normal	Input 1	Input Dry Contact	0 (Open)
Normal	Input 2	Input Dry Contact	0 (Open)

3

In the Portal tab, check the Portal field and click on **Save**.

Portal Message

[SensDesk.com](http://sensdesk.com) - Check sensor online

Portal config

NAME	VALUE	DESCRIPTION
Portal	<input checked="" type="checkbox"/>	Portal Enable/Disable
Server Address	<input type="text" value="http://sensdesk.com/portal.php"/>	IP Address or DNS Name
IP Port	<input type="text" value="80"/>	Default 80
Username	<input type="password" value="*****"/>	Push device access parameters see at 85_account on Sensdesk
PUSH Password	<input type="password" value="*****"/>	

Input(s) AutoPush config

ID	NAME	CURRENT VALUE	AUTOPUSH
1	Input 1	0 (Open)	<input type="checkbox"/>
2	Input 2	0 (Open)	<input type="checkbox"/>

Sensor(s) AutoPush config

ID	NAME	CURRENT VALUE	AUTOPUSH
6291	Sensor 6291	25.0 °C	<input type="text" value="5.0"/>
6292	Sensor 6292	56.1 %RH	<input type="text" value="5.0"/>

Portal Debug

Push Period	900	[s]
Log Period	300	[s]
Current Push Timer	682	[s]
Current Log Timer	185	[s]
AutoPush Block Timer	0	[s]

Save

4

Click on the [SensDesk.com: register your IP sensor](http://sensdesk.com) link to connect to the www.sensdesk.com, directly to the login dialogue.

SensDesk IP sensors portal

Address: 192.168.200.14
Port: 80

Username:
Password:

ID	State	Sensor Name	Value	Unit	Active/In
59.890	✓	Sensor 44866	25.3	°C	1 hour 5 sec ago
59.891	✓	Input 1	0		1 hour 5 sec ago
59.892	✓	Input 2	0		1 hour 5 sec ago

Custom interval: Day Week Monthly

Chart start date: 2016-09-15
E.g. 2016-09-17
16:37 | 18:37
E.g. 09:37 | 09:37

Temperature [C] | Switches [s]

SensDesk IP sensors portal

Username *

Password *

Register reset password

Log in

- 5 If you already have a user account, enter your login data and the device will automatically be added to your account.

If you do not have a user account yet, click on the [Register to Portal](#) link to open the registration form.

- 6 Enter your login data and a valid e-mail address. The **e-mail address must be unique for the entire portal**, meaning you must use an address that has not been registered yet.

The *Company name* item allows you to create your own 3rd level domain (typically company.sensdesk.com). If you do not complete it, the username will be used.

After clicking on [Create new account](#) a user account will be created and a confirmation e-mail sent to the entered address. In the e-mail, you will find a link that you must click on to activate the account.

The screenshot shows the registration form for SensDesk IP sensors portal. The form includes the following fields and options:

- Username ***: Text input field.
- E-mail address ***: Text input field.
- Password ***: Text input field.
- Confirm password ***: Text input field.
- Company name**: Text input field, highlighted with a blue box. Below it is the text: "Name for your subdomain or leave blank to use username".
- Country ***: Dropdown menu with the text "- Select a value -".
- HW group device(s) ***: Text input field. Below it is the text: "Write us which HW group device(s) you plan to use with SensDesk."
- I agree with license conditions ***: A checkbox.
- Word verification ***: A CAPTCHA image showing the word "POWQ" in a stylized font. Below it is a text input field and the text "(verify using audio)".
- Below the word verification field is the text: "Type the characters you see in the picture above; if you can't read them, submit the form and a new image will be generated. Not case sensitive."
- At the bottom of the form are two links: "Log-in to Portal or reset password or" and "Create new account".

At the bottom of the page, there is a blue banner with a question mark icon and the text: "You don't have to register, check the SensDesk.com with the USERNAME 'demo' and PASSWORD 'demo'".

7

In your user account configuration [My Account](#) link), you will find the [Push Device Password](#) item. This password with your username serves for communication of the device with your account and for communication of mobile applications with SensDesk.

The password cannot be changed and for security reasons is different from the user account password.

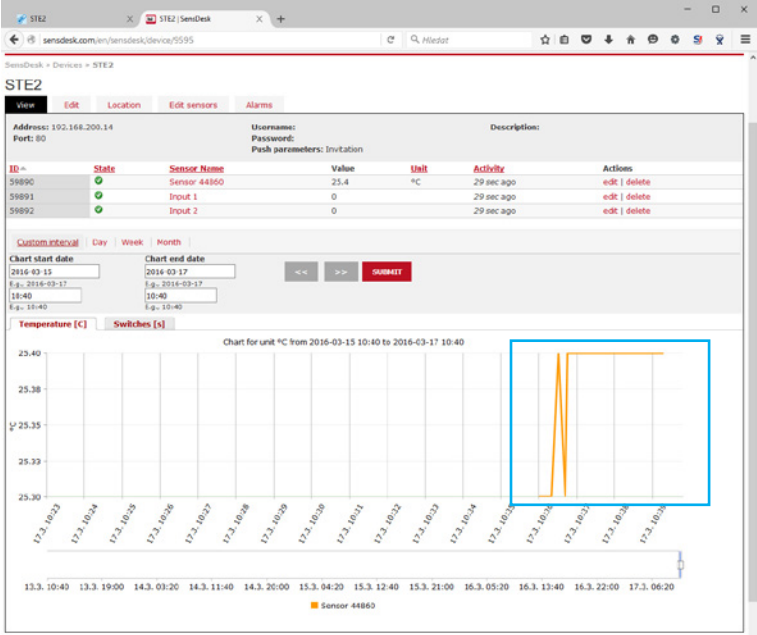

The screenshot shows the SensDesk 'Test' configuration page. At the top, there are links for 'Login: Test', 'Help | My account | License | Log out'. Below this, there are tabs for 'Dashboard', 'Devices', 'Sensors', and 'Device groups'. The 'Test' section has tabs for 'View', 'Edit', '3rd party XML Integration', and 'Mobile apps'. The 'Email' section shows 'Plaintext email only' set to 'No'. The 'Portal configuration in devices' section has a 'Push device password' field highlighted with a blue box, containing the value 'Lx5d22'. Other fields include 'Country: Czech Republic', 'HW group device(s): HWg-STE', and 'History' showing 'Member for 3 min 43 sec'. A link 'Send this user a private message' is also present.

This password can be entered manually on the device website in the portal settings, to avoid going through registration and login.

Portal Message

SensDesk.com, Check sensor online.

Portal config

NAME	VALUE	DESCRIPTION
Portal	<input checked="" type="checkbox"/>	Portal Enable/Disable
Sensor Address	<input type="text" value="http://sensdesk.com/portal.php"/>	IP Address or DNS Name
IP Port	<input type="text" value="80"/>	Default 80
Username	<input type="password" value="*****"/>	Push device access parameters see at Mo_account on SensDesk
PUSH Password	<input type="password" value="*****"/>	

Input(s) AutoPush config

ID	NAME	CURRENT VALUE	AUTOPUSH
1	Input 1	0 (Open)	<input type="checkbox"/>
2	Input 2	0 (Open)	<input type="checkbox"/>

Sensor(s) AutoPush config

6291	Sensor 6291	25.0 °C	<input type="text" value="5.0"/>
6292	Sensor 6292	56.1 %RH	<input type="text" value="5.0"/>

Save

Portal Debug

Push Period	900	[s]
Log Period	300	[s]
Current Push Timer	682	[s]
Current Log Timer	185	[s]
AutoPush Block Timer	0	[s]

Using the mobile phone app

The **Username** and **PUSH Device** password can also be used in the application settings on mobile phones.



The screenshot shows the SensDesk Mobile app interface. At the top, there is a status bar with various icons and the time 17:33. Below the status bar, the app title "SensDesk Mobile" is displayed. The main content area features a table with columns for location, alarm count, and device name. The "ALARMS" tab is selected, and the table is sorted by "DEVICES".

ALL	ALARMS	Sort by DEVICES ▾
STE2 Home	0	Input 1
STE2 Home	0	Input 2
STE2 Home	27.3 °C	Sensor 47117
STE2 Work	0	Input 1
STE2 Work	0	Input 2

At the bottom of the screen, there is a navigation bar with five icons: a square, a starburst, a circle, a square with a smaller square inside, and a triangle pointing left.

Firmware upgrade in STE2 units

- 1 Open the STE2 unit web interface in the *System* tab.

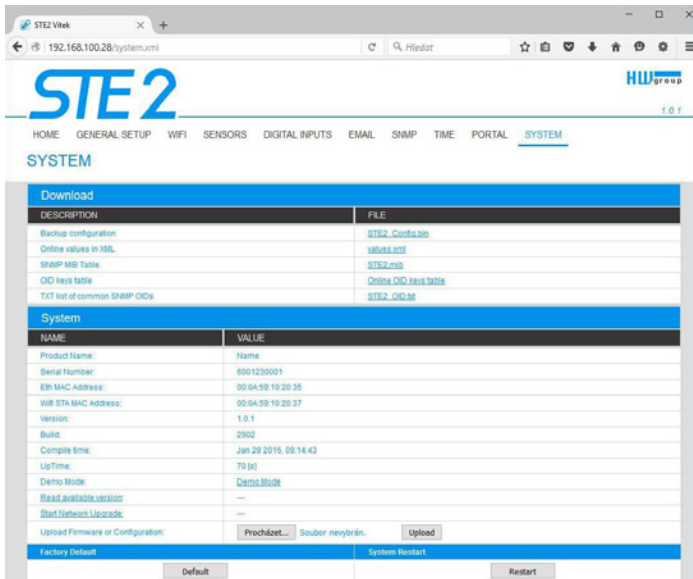

- 2 The *System* section contains items to identify and download the current FW version.

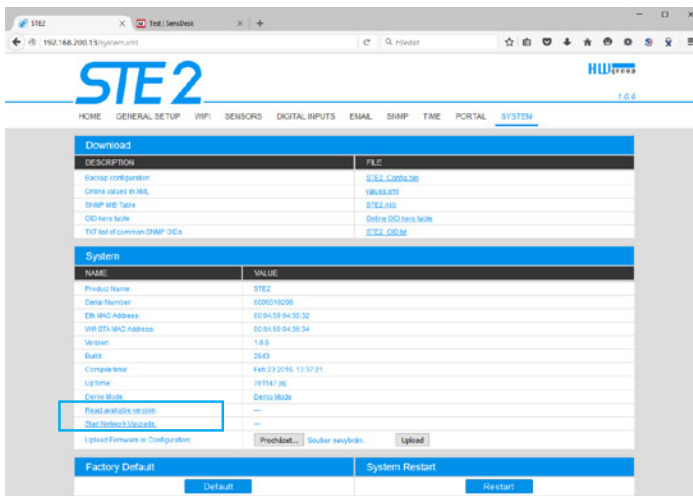

- 3 **Read available version** – Serves to identify and display the current firmware version on the update server. Click on the **Read available version** link.

System	
NAME	VALUE
Product Name:	Name
Serial Number:	6001230001
Eth MAC Address:	00:0A:59:10:20:35
Wifi STA MAC Address:	00:0A:59:10:20:37
Version:	1.0.1
Build:	2902
Compile time:	Jan 29 2016, 09:14:43
UpTime:	303 [s]
Demo Mode:	Demo Mode
Read available version:	1.0.2
Start Network Upgrade:	---

- 4 **Start Network Upgrade** – Serves to upgrade firmware to the device. The download progress is displayed while upgrading. Click on the **Start Network Upgrade** link.

System	
NAME	VALUE
Product Name:	Name
Serial Number:	6001230001
Eth MAC Address:	00:0A:59:10:20:35
Wifi STA MAC Address:	00:0A:59:10:20:37
Version:	1.0.1
Build:	2902
Compile time:	Jan 29 2016, 09:14:43
UpTime:	402 [s]
Demo Mode:	Demo Mode
Read available version:	1.0.2
Start Network Upgrade:	Download status 326475, 6171

- 5 After the upgrade, the user is requested to restart the device manually.

System	
NAME	VALUE
Product Name:	Name
Serial Number:	6001230001
Eth MAC Address:	00:0A:59:10:20:35
Wifi STA MAC Address:	00:0A:59:10:20:37
Version:	1.0.1
Build:	2902
Compile time:	Jan 29 2016, 09:14:43
UpTime:	303 [s]
Demo Mode:	Demo Mode
Read available version:	1.0.2
Start Network Upgrade:	--

To do this, press the [Restart](#) button. **The device will not restart automatically and this must be done manually.**

Check the firmware version after restart.

System	
NAME	VALUE
Product Name:	Name
Serial Number:	6001230001
Eth MAC Address:	00:0A:59:10:20:35
Wifi STA MAC Address:	00:0A:59:10:20:37
Version:	1.0.1
Build:	2902
Compile time:	Jan 29 2016, 09:14:43
UpTime:	402 [s]
Demo Mode:	Demo Mode
Read available version:	1.0.2
Start Network Upgrade:	Download status 326475, 6171

Notes



HW group s.r.o.
Rumunská 26/122
Prague 2, 120 00
Czech Republic

Phone: +420 222 511 918
Fax: +420 222 513 833

www.HW-group.com