

Portable Gas Monitor 04 Series

Technical Manual (PT0-189)

RIKEN KEIKI Co., Ltd.

2-7-6 Azusawa, Itabashi-ku, Tokyo, 174-8744, Japan

Website: <http://www.rikenkeiki.co.jp/>

Contents

1. Product Overview	5
1-1. Introduction	5
1-2. Intended use	7
1-3. DANGER, WARNING, CAUTION, and NOTE	8
2. Important Safety Information	9
2-1. Danger information	9
2-2. Warning information	12
2-3. Caution information	15
2-4. Safety information	19
3. Product Configuration	21
3-1. Main unit and accessories	21
3-2. Part names and functions	23
3-2-1. Main unit	23
3-2-2. LCD display	25
3-3. Inserting the batteries	26
4. Alarm Functions	30
4-1. Gas alarm types and alarm setpoints	30
4-2. Gas alarm activation	34
4-3. Fault alarm activation	36
4-4. Outside operating temperature range warning	37
5. Usage Instrucions	38
5-1. Usage note	38
5-2. Preparing startup	38
5-3. Turning on the power	39
5-4. Performing air calibration	45
5-5. Measuring gas concentration	48

5-6. Checking the gas concentration, alarm setpoints, etc. (display mode)	50
5-6-1. Procedure for displaying display mode	50
5-6-2. Items displayed in display mode	51
5-7. Turning off the power	56
6. User Mode Settings.....	57
6-1. User mode setting procedure	57
6-2. User mode setting items	60
6-3. Calibration expiration setting (CAL SET)	64
6-3-1. Calibration expiration ON/OFF (CAL.RMDR)	65
6-3-2. Calibration expiration date interval (CAL.INT).....	66
6-3-3. Setting operation after calibration date expires (CAL.EXPD)	67
6-4. Bump test expiration setting (BUMP.SET).....	69
6-4-1. Bump test setting (SETTING).....	70
6-4-2. Bump test expiration ON/OFF (BP.RMDR).....	74
6-4-3. Bump test expiration date interval setting (BP.INT).....	75
6-4-4. Setting behavior after bump test expiration (BP.EXPD).....	76
6-5. Alarm setpoint setting (ALARM-P)	78
6-5-1. Alarm setpoint setting (ALARM-P).....	79
6-5-2. Resetting alarm setpoints (DEF.ALMP).....	85
6-6. Lunch break ON/OFF (LUNCH)	86
6-7. Confirmation beep setting (BEEP).....	87
6-7-1. Beep operation setting (BEEP.SEL).....	88
6-7-2. Beep interval setting (BEEP.INT)	89
6-8. LCD lighting time setting (BL TIME).....	90
6-9. Key operation tone ON/OFF (KEY.TONE).....	91
6-10. Display mode item display ON/OFF (DISP.SET).....	92
6-11. Quick calibration time setting (E-CAL)	93
6-12. Date and time setting (DATE)	94
6-13. User mode password setting (PASS-W).....	95

6-14. ROM/SUM display (ROM/SUM)	96
7. Maintenance	97
7-1. Maintenance intervals and maintenance items	97
7-2. Performing calibration	99
7-2-1. Preparation for calibration	99
7-2-2. Displaying the calibration (GAS CAL) screen	108
7-2-3. Performing air calibration.....	109
7-2-4. Performing AUTO calibration.....	112
7-3. Performing bump tests.....	121
7-4. Performing alarm tests	127
7-5. Cleaning instructions.....	129
7-6. Parts replacement.....	130
7-6-1. Periodic replacement parts.....	130
7-6-2. Filter replacement.....	132
7-6-3. Sensor replacement	136
8. Storage and Disposal.....	140
8-1. Procedures for storage or when not in use for extended periods.....	140
8-2. Product disposal.....	141
9. Troubleshooting.....	142
9-1. Product abnormalities	142
10. Product Specifications.....	144
10-1. Common specifications.....	144
10-2. Specifications by model	146
11. Appendix	148
11-1. Data logger function	148
11-2. Terminology	151

1

Product Overview

1-1. Introduction

Thank you for your purchase of the 04 Series Portable Gas Monitor (“product” hereinafter).

This operating manual describes product operating procedures and specifications. It provides information essential to correct use of the product.

Make sure you have read and fully understood the contents of this manual before using the product.

Keep this operating manual on hand to allow ready reference during use.

The contents of this manual are subject to change without notice to allow product improvements. Any duplication or reproduction of this manual without permission is prohibited, whether in whole or in part.

Riken Keiki accepts no liability for accidents or damage resulting from use of the product, whether within or outside the warranty period.

Review the warranty policy indicated on the warranty.

<Checks made after purchase>

Before using the product, please confirm that the model of the product you purchased matches the model of the product covered by this operating manual.

Models covered by this operating manual

- OX-04G
- OX-04
- CO-04
- HS-04
- CO-04 (C-)
- CX-04
- SC-04 (SO₂)

<This operating manual>

In this operating manual, where descriptions differ according to the model, the following icons are used to indicate each of the models:

OX-04G	
OX-04	
CO-04	
HS-04	
CO-04 (C-)	
CX-04	
SC-04 (SO₂)	

Operating procedures and specifications for which no icons appear apply to all models.

In cases without significant differences from model to model, the display examples are taken from the CO-04 (CO) (detection target gas: CO (carbon monoxide)).

1-2. Intended use

The product is a portable gas monitor for personal use designed to detect gases in the surrounding atmosphere. It measures concentrations of toxic gases and oxygen in the atmosphere and issues an alarm when gas concentrations reach preset levels, thereby alerting users to the hazards of gas poisoning and oxygen deficiency.

The detection results are not intended to assure life or safety.

Seven models are available to detect various detection target gases.

Check the specifications before use to confirm the correct gases will be detected in accordance with the intended purpose.



<List of detection target gases by model>

Model	Detection target gas
OX-04G	Oxygen (galvanic cell type)
OX-04	Oxygen (electrochemical type)
CO-04	Carbon monoxide
HS-04	Hydrogen sulfide
CO-04 (C-)	Carbon monoxide*
CX-04	Carbon monoxide, oxygen
SC-04 (SO ₂)	Sulfur dioxide

*The carbon monoxide sensor (ESR-A1CP) includes a correction function to reduce hydrogen interference. This function works for hydrogen concentrations up to 2,000 ppm.

1-3. DANGER, WARNING, CAUTION, and NOTE

This operating manual uses the following categories to indicate potential damage/hazards if the user disregards the information provided and uses the product incorrectly:

 DANGER	This indicates situations in which improper handling may result in fatal or serious injury or significant property damage.
 WARNING	This indicates situations in which improper handling may result in serious injury or significant property damage.
 CAUTION	This indicates situations in which improper handling may result in minor injury or minor property damage.

Additionally, usage recommendations are indicated as follows:

NOTE	This indicates items that will be helpful to know when using the product.
-------------	---

2

Important Safety Information

To maintain the performance of the product and to ensure safe use, always observe the following DANGER, WARNING, and CAUTION instructions.

2-1. Danger information



Explosion-proofing

- Do not modify or alter the circuitry or configuration.
- When using the product in hazardous areas, take the following precautions to safeguard against static electricity hazards:
 - Wear anti-static clothing and conductive shoes (anti-static work shoes).
 - When using the product indoors, stand on a conductive work floor (with a leakage resistance of 10 MΩ or less).
- Be sure to replace the batteries in a safe place.
- Use the batteries indicated on the certification plate attached to the main unit. The required explosion-proof performance cannot be assured if batteries other than those specified are used.

The battery specifications are as follows:

<Dry cell specifications>

- The explosion-proof class is Ex ia IIC T4 Ga.
- The ratings are as follows:
 - Domestic models:
Power source: 3 V DC (Toshiba LR03 battery × 2)
Ambient temperature: -40 °C to +60 °C
 - Export models:
Power source: 3 V DC, 1 mA (Toshiba LR03, Duracell MN2400, or Duracell PC2400 battery × 2)
Ambient temperature: -40 °C to +60 °C
- Does not accept rechargeable batteries.

<Rechargeable battery specifications>

- The explosion-proof class is Ex ia IIC T3 Ga.
- The ratings are as follows:
 - Power source: 2.4 V DC, 1 mA (Panasonic eneloop (BK-4MCC) battery × 2)
 - Ambient temperature: -40 °C to +60 °C
- Use two eneloop (BK-4MCC) (Panasonic) batteries. Does not accept dry cell batteries.
- Use a BQ-CC23 (Panasonic, -Delta Vt control recharging) recharger.
- The rating for recharging is 1.5 V DC, 550 mA.
- Recharge the batteries only in nonhazardous locations.
- If the product is used as an explosion-proof device, note that the explosion-proofing rating conditions specify the battery type to be used.

The battery types are as follows:

<Dry cell specifications>

- Domestic models:
Power source: 3 V DC, 1 mA (Toshiba LR03 battery × 2)

- Export models:

Power source: 3 V DC, 1 mA (Toshiba LR03, Duracell MN2400, or Duracell PC2400 battery × 2)

<Rechargeable battery specifications>

eneloop (BK-4MCC) (Panasonic) rechargeable battery × 2

- Guidelines

<Export models (IECEX)>

- IEC 60079-0:2017
- IEC 60079-11:2011

<Export models (ATEX)>

- EN60079-0:2018
- EN60079-11:2012

<Domestic models (JPEX)>

- JNIOOSH-TR-46-1:2015
- JNIOOSH-TR-46-6:2015



DANGER

OX G

OX

CX

Usage

- When measuring inside manholes or enclosed spaces, never lean over or look into the manhole or enclosed space.
Such locations may generate and discharge oxygen-deficient air or other gases.

2-2. Warning information



WARNING

Air calibration in the atmosphere

- When air calibration is performed in the atmosphere, check the atmosphere for freshness before starting. The presence of interference gases will prevent proper air calibration. The presence of interference gases is also extremely dangerous because the product may not detect actual gas leaks correctly.

Battery level check

- Check battery levels before using the product. The batteries may become depleted if not used for extended periods.

Always replace with new batteries before use.

The battery types are as follows:

<Dry cell specifications>

- Domestic models:

Power source: 3 V DC, 1 mA (Toshiba LR03 battery × 2)

- Export models:

Power source: 3 V DC, 1 mA (Toshiba LR03, Duracell MN2400, or Duracell PC2400 battery × 2)

<Rechargeable battery specifications>

eneloop (BK-4MCC) (Panasonic) rechargeable battery × 2

- If a low battery voltage alarm occurs, gas cannot be detected. If a low battery voltage alarm occurs during use, turn off the power and replace the batteries.

Handling the calibration gas

- The calibration gas is nitrogen or toxic gas. Inhaling the gas may lead to loss of health or even death. When using calibration gas, discharge outside, perform calibration in a well-ventilated area, or use local ventilation equipment.
- Calibration gas must be used by itself. Calibration can be performed with a gas mixture. However, calibrations performed with a gas mixture will result in poor sensitivity and inaccurate concentration readings. But, in the calibration of GW-3(CX), nitrogen and carbon monoxide can use not only itself but also the mixed gases.

Sensor handling

- Never disassemble the electrochemical type sensor inside the product. Contact with the electrolyte inside the sensor may result in skin inflammation. Contact with eyes may result in blindness. Contact with clothing may result in discoloration or holes. If contact with electrolyte occurs, rinse the area immediately with plenty of water.
- Do not use any gas other than nitrogen as the balance gas when calibrating or adjusting an oxygen sensor.

Miscellaneous

- Do not dispose of the product into fire.
 - Do not wash the product, either in a washing machine or an ultrasonic cleaning machine.
 - Do not block the buzzer sound opening. Doing so will muffle or silence the audible warning.
 - Do not remove the batteries while the power is turned on.
-

**WARNING OX G CX****Battery replacement or sensor replacement**

- An OVER alarm may occur if the power is turned on within 10 minutes of replacing the battery or the sensor. This is due to the characteristics of the sensor. If an OVER alarm occurs in fresh air after replacing the battery or the sensor, turn off the power, then turn the power on again after waiting at least 10 minutes.

**WARNING C-****Handling the calibration gas**

- The carbon monoxide sensor with hydrogen compensation must be calibrated separately for carbon monoxide and hydrogen.
- If hydrogen sensitivity calibration is not performed, carbon monoxide readings may be inaccurate due to hydrogen interference.
- Due to the hydrogen compensation mechanism, carbon monoxide readings may increase temporarily if hydrogen gas concentrations increase rapidly in the atmosphere being measured.

2-3. Caution information



CAUTION

Do not use the product in locations where it may be exposed to oil, chemicals, or other such substances.

Avoid deliberately submerging the product in water.

- Do not use the product in locations where it may be exposed to oil, chemicals, liquids, or other such substances.

Do not use walkie-talkies near the product.

- The product's functions may be affected by radio waves emitted from walkie-talkies or other radio transmitters used nearby.

Position any transceivers or other similar devices so that they do not affect the product's functions.

- Avoid using the product near devices that emit strong electromagnetic radiation (high frequency or high voltage devices).

Be sure to perform regular maintenance.

- The product is a safety device. Maintain the product regularly to ensure safety.

Continuing to use the product without adequate maintenance will result in sensor sensitivity variations, preventing accurate gas detection.

Maintenance

- Replace filters every six months.
- Handle filters carefully. Do not use this product with damaged filters.

Do not use the product in locations outside the operating temperature and humidity ranges.

- The operating temperature and humidity ranges for the product are as follows: Avoid using the product at temperatures or humidity levels outside the indicated operating range.

OX-04G:

Continuous use environment: Temperature: -20 °C to +50 °C Humidity: 10 %RH to 90 %RH

OX-04,HS-04,CO-04,CO-04(C-),CX-04,SC-04(SO2):

Continuous use environment: Temperature: -20 °C to +50 °C Humidity: 10 %RH to 90 %RH

Temporary use environment: Temperature: -20 °C to +60 °C Humidity: 0 %RH to 95 %RH

- Avoid using for extended periods in locations exposed to direct sunlight.
- Avoid storing the product inside parked vehicles in hot weather.
- Note that humidity may affect readings even when humidity is within the specified range.

Air calibration

- Air calibrate the product using fresh air at pressures, temperatures, and humidity levels similar to the actual usage environment.
- Wait for the readout to stabilize before performing air calibration.
- If the temperature difference between the storage location and usage location is 15 °C or greater, turn on the power, allow the product to adjust to ambient conditions similar to those at the usage location for about a few tens of minutes*¹, and perform air calibration using fresh air before using the product.

Miscellaneous

- Pressing buttons unnecessarily may change settings and prevent alarms from activating correctly. Avoid performing any operations not described in this operating manual.
- Do not drop the product or subject it to impact. Doing so may degrade waterproof and explosion-proof performance or reduce sensitivity.
- Do not poke the sensor or buzzer sound opening with sharp or pointed items. Doing so may result in malfunctions or damage to the product, preventing accurate measurements.
- The product is a precision device. Do not subject the product to strong impact or vibration.
- Keep the product away from magnetic fields. Magnetic fields may cause the product to fail or malfunction. If the product does not operate correctly, use it away from magnetic fields.

Battery replacement

- Be sure to turn off the power for the product when replacing the batteries.
- Always replace the batteries with new batteries.
- Note the polarity when inserting the batteries. If inserted with the wrong polarity, the screen for setting date and time will appear the next time the power is turned on.
- Do not use any batteries other than the types specified.
- Be sure to replace the batteries in a safe place.
- Replace the battery promptly, then wait at least 10 minutes before turning the power on. If the product is stored for extended periods with the battery removed, a [FAIL SENSOR] (sensor abnormality) alarm may occur in rare cases when the power is turned on. If this occurs, wait at least a few tens of minutes*² before turning the power back on.

Storage

- If the product will not be used for extended periods, store with the batteries removed. Battery leaks may result in fire or injury.

*1 OX-04G:30 minutes / OX-04,HS-04,CO-04,CO-04(C-),CX-04,SC-04(SO₂):10 minutes

*2 OX-04G,HS-04,CO-04,CO-04(C-),SC-04(SO₂):5 minutes / OX-04,CX-04:10 minutes



CAUTION

OX

CO

HS

C-

CX

SO₂

Gas alarm activation

- If sensor has been exposed to high concentrations of gas (including the detection target gas or interference gas), it may take several minutes, or even several hours, for the display readout to return to zero (or 20.9 %). (For example, high concentrations of hydrogen, unsaturated hydrocarbons, alcohol, etc.)

**CAUTION****OX****CX****Sensor**

- Do not expose the product to sudden pressure fluctuations. Oxygen readings will fluctuate briefly, preventing accurate measurement.
- Do not use any gas other than nitrogen as the balance gas. Otherwise, oxygen reading errors will increase, preventing accurate measurement.

**CAUTION****C-****Calibration**

- Calibration of hydrogen gas may become impossible when the product is used or stored for extended periods in dry environments.
If [FAIL A-CAL] (calibration abnormality) appears during hydrogen sensitivity calibration, leave the product overnight or longer in a location with sufficient humidity, then perform calibration once again. If it is not possible to perform CO sensitivity calibration, contact Riken Keiki to request sensor replacement.

2-4. Safety information

This product is a portable single-gas/two-gas monitor to detect gas.

This product uses two AAA alkaline batteries (Toshiba LR03 or Duracell MN2400/PC2400) or two AAA Ni-MH batteries (Panasonic eneloop (BK-4MCC)) for power supply. Perform battery replacement only in a non-hazardous area.

<Specifications for safety>

- Ex ia IIC T4/T3 Ga
-  II 1G Ex ia IIC T4/T3 Ga
- Ambient temperature range: -40 to +60 °C

<Electrical data>

- T4: Powered by two series-connected alkaline batteries, LR03 by Toshiba or MN2400/PC2400 by Duracell (Only LR03 by Toshiba can be used for domestic models.)
- T3: Powered by two series-connected AAA Ni-MH batteries, eneloop (BK-4MCC) by Panasonic

<Certificate numbers>

- IECEx certificate number: IECEx DEK 19.0059
- ATEX certificate number: DEKRA 19 ATEX 0097

<List of standards>

- | | |
|---------------------|-------------------|
| • IEC 60079-0:2017 | • EN60079-0:2018 |
| • IEC 60079-11:2011 | • EN60079-11:2012 |

**WARNING**

- Do not replace batteries in hazardous locations.
- Do not attempt to disassemble or alter the product.
- Use only two series-connected AAA alkaline batteries, LR03 manufactured by Toshiba or MN2400/PC2400 by Duracell, or use two series-connected AAA Ni-MH batteries, eneloop (BK-4MCC) manufactured by Panasonic.
 - T4: LR03 manufactured by Toshiba or MN2400/PC2400 by Duracell
(Only LR03 by Toshiba can be used for domestic models.)
 - T3: eneloop (BK-4MCC) manufactured by Panasonic

INST. No. 0 0 0 0 0 0 0 0 0 0
 A B C D E

- A: Manufacturing year (0-9)
B: Manufacturing month (1-9, XYZ for Oct.-Dec.)
C: Manufacturing lot
D: Serial number
E: Code of factory

**RIKEN KEIKI Co., Ltd.**

2-7-6 Azusawa, Itabashi-ku, Tokyo, 174-8744, Japan

Phone: +81-3-3966-1113
Fax: +81-3-3558-9110
Email: intdept@rikenkeiki.co.jp
Website: <http://www.rikenkeiki.co.jp>



3

Product Configuration

3-1. Main unit and accessories

Open the box and packaging and inspect the main unit and accessories.
If anything is missing, contact Riken Keiki.

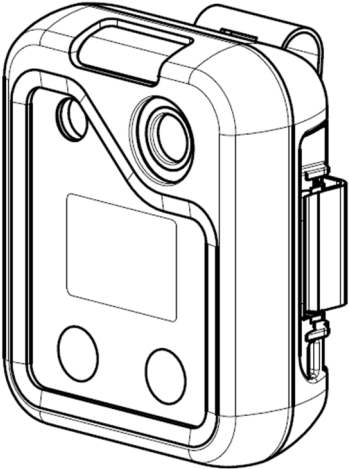
<Main unit and standard accessories>

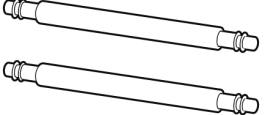
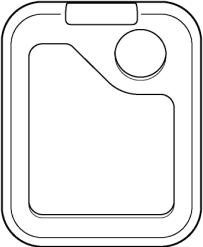
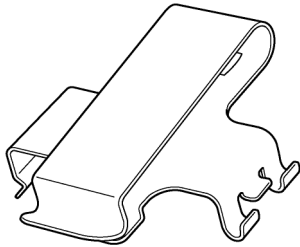
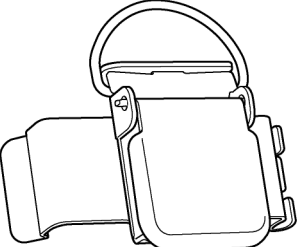
Main unit	Standard accessories		
	Dry cell specifications: AAA alkaline battery × 2 (fitted) Rechargeable battery specifications: AAA Ni-MH battery × 2 (fitted)	Spring bar × 2 (fitted)	Operating manual × 1 Product warranty × 1
			
	Rubber protection cover × 1 (fitted)	Belt clip × 1 (fitted) Domestic models	Alligator clip × 1 Export models
			

<Optional items (sold separately)>

- Dust filter
- Filters
 - CO-04, CO-04 (C-): Interference gas removal filter CF-1821
 - HS-04: Humidity control filter CF-A13i-1
 - CX-04: Interference gas removal filter CF-6280
 - SC-04 (SO₂): H₂S removal filter CF-A13D-1
- Belt clip
- Alligator clip
- Helmet mounting clip (for carbon monoxide sensor)
- Heat-resistant case
- Calibration adapter
- Hand strap
- Band
- Data logger management program

3-2. Part names and functions

3-2-1. Main unit

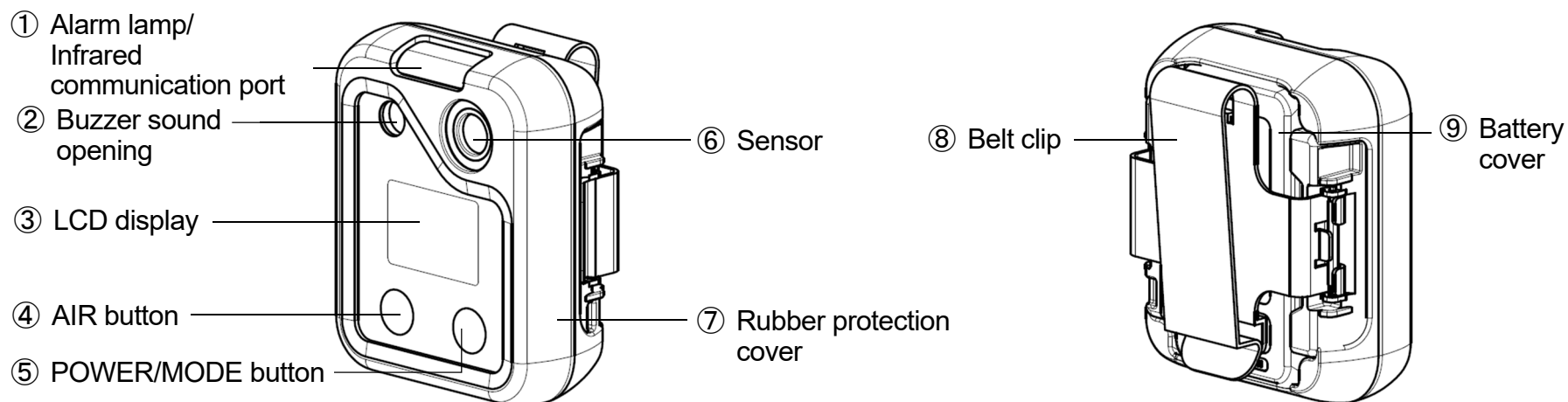

No.	Name	Function
①	Alarm lamp/Infrared communication port	Flashes red when an alarm occurs. This is used for data communication with a PC when using the data logger management program (sold separately)*.
②	Buzzer sound opening	Opening that emits operating and alarm sounds. Blocking the buzzer sound opening will muffle or silence the audible warning.
③	LCD display	Displays the detection target gas name, gas concentration, battery level, etc.

No.	Name	Function
④	AIR button	Performs air calibration in measurement mode. Used to select functions when in user mode, etc.
⑤	POWER/MODE button	Turns the power on/off. Confirms operations when in user mode, etc.
⑥	Sensor	The sensor for detecting gas is installed.
⑦	Rubber protection cover	Cover protecting the product
⑧	Belt clip	Used when clipping to a belt
⑨	Battery cover	Cover protecting the batteries

*The data logger management program is sold separately. For more information, refer to the operating manual for the data logger management program.

3-2-2. LCD display

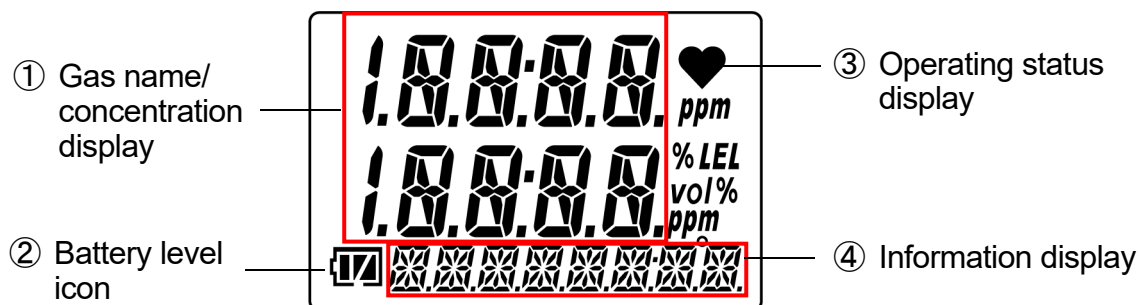

No.	Name	Function
①	Gas name/ concentration display	Displays the detection target gas name and gas concentration.
②	Battery level icon	Indicates battery levels.
③	Operating status display	Indicates the operating status in measurement mode. Blinks when normal. The blinking interval changes from approximately once every second to approximately once every two seconds if no operation is performed for about 30 seconds. In user mode, the blinking interval changes to approximately once every four seconds.
④	Information display	Displays various information.

NOTE

- ▶ The following is a guide to battery levels:

: Sufficient / : Low / : Replace the batteries.

The battery level icon will blink () if battery levels drop even further.

- ▶ If the bump test expiration setting is ON and the bump test expiration date has not passed, [✓] is displayed in the lower part of the LCD. (Refer to '6-4-2. Bump test expiration ON/OFF (BP.RMDR)'.)

3-3. Inserting the batteries

When using the product for the first time or when battery levels are low, insert/replace with two new batteries.

The battery types are as follows:

<Dry cell specifications>

- Domestic models:

Power source: 3 V DC, 1 mA (Toshiba LR03 battery × 2)

- Export models:

Power source: 3 V DC, 1 mA (Toshiba LR03, Duracell MN2400, or Duracell PC2400 battery × 2)

<Rechargeable battery specifications>

eneloop (BK-4MCC) (Panasonic) rechargeable battery × 2

1 Confirm that the power for the product is turned off.

If the power is on, hold down the POWER/MODE button for at least three seconds to turn off the power.

2 Use a flathead screwdriver to loosen the battery cover retaining screw, then open the battery cover.

If a belt clip has been fitted, open the belt clip.

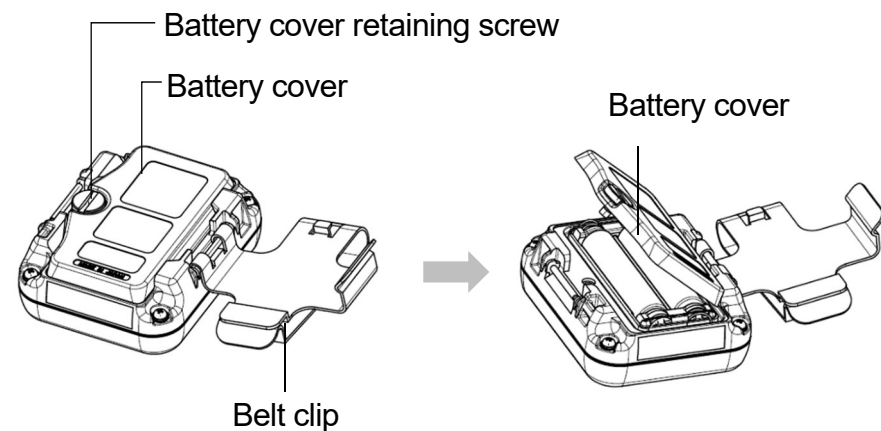

3 Remove the old batteries, then insert new batteries. Note the polarity.

When removing the batteries, push the [+] end toward the [-] end and then lift out. Remove the batteries one at a time.

When inserting the batteries, match the polarity markings to the markings inside the product.

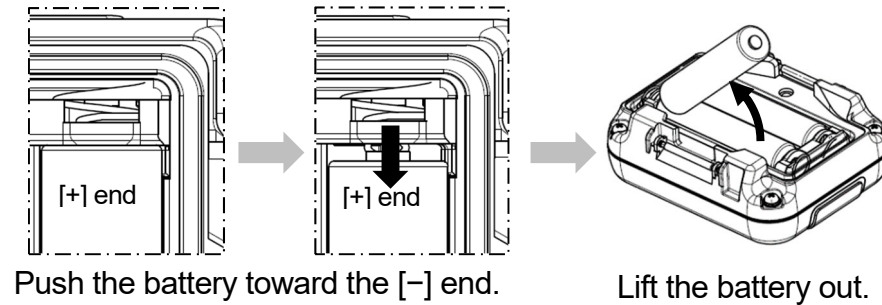
4 Close the battery cover, then tighten the battery cover retaining screw with the flathead screwdriver.**DANGER**

- If the product is used as an explosion-proof device, note that the explosion-proofing rating conditions specify the battery type to be used.
The battery types are as follows:
<Dry cell specifications>
 - Domestic models:
Power source: 3 V DC, 1mA (Toshiba LR03 battery × 2)
 - Export models:
Power source: 3 V DC, 1 mA (Toshiba LR03, Duracell MN2400, or Duracell PC2400 battery × 2)<Rechargeable battery specifications>
 - eneloop (BK-4MCC) (Panasonic) rechargeable battery × 2

**WARNING** 

- An OVER alarm may occur if the power is turned on within 10 minutes of replacing the batteries or the sensor. This is due to the characteristics of the sensor. If an OVER alarm occurs in fresh air after replacing the batteries or the sensor, turn off the power, then turn the power on again after waiting at least 10 minutes.
-

**CAUTION**

- Be sure to turn off the power for the product when replacing the batteries.
 - Always replace with two new batteries of the same type.
 - Note the polarity when inserting the batteries.
 - Do not use any batteries other than the types specified.
 - Be sure to replace the batteries in a safe place.
 - The date and time setting screen will appear in the following cases. Set the date and time referring to '6-12. Date and time setting (DATE)'.
 - When the batteries are first inserted
 - When the batteries are inserted after the product has been left for five minutes or longer without batteries when replacing the batteries, etc.
 - When the batteries are inserted with the wrong polarity
 - When a button is pressed without batteries when replacing the batteries, etc.
-



CAUTION OX G OX CO HS C- SO2

- The sensor will take about five minutes to stabilize after the batteries are replaced. After replacing the batteries, wait at least five minutes before using the product.
-



CAUTION CX

- The sensor will take about 10 minutes to stabilize after the batteries are replaced. After replacing the batteries, wait at least 10 minutes before using the product.
-

4

Alarm Functions

4-1. Gas alarm types and alarm setpoints

OX G OX

A gas alarm is triggered if the concentration of the detected gas reaches or exceeds the alarm setpoints shown in the following table. (Self-latching)

Gas alarm types include the first alarm (WARNING), second alarm (ALARM), third alarm (ALARM H), and OVER alarm (OVER).

Alarm type		First alarm (WARNING)	Second alarm (ALARM)	Third alarm (ALARM H)	OVER alarm (OVER)
Measured gas name	Oxygen	18.0 %	18.0 %	25.0 %	40.0 %

CO C-

A gas alarm is triggered if the concentration of the detected gas reaches or exceeds the alarm setpoints shown in the following table. (Domestic models: Auto reset/Export models: Self-latching)

Gas alarm types include the first alarm (WARNING), second alarm (ALARM), third alarm (ALARM H), STEL alarm (STEL), cumulative alarm (A-1H) or TWA alarm (TWA)*, and OVER alarm (OVER).

Alarm type			First alarm (WARNING)	Second alarm (ALARM)	Third alarm (ALARM H)	STEL alarm (STEL)	Cumulative alarm (A-1H)	TWA alarm (TWA)	OVER alarm (OVER)
Measured gas name	Carbon monoxide	Domestic	50 ppm	150 ppm	150 ppm	200 ppm	150 ppm	-	2,000 ppm
		Export	25 ppm	50 ppm	1,200 ppm	200 ppm	-	25 ppm	2,000 ppm

*Domestic models: Cumulative alarm/Export models: TWA alarm

HS

A gas alarm is triggered if the concentration of the detected gas reaches or exceeds the alarm setpoints shown in the following table. (Self-latching)

Gas alarm types include the first alarm (WARNING), second alarm (ALARM), third alarm (ALARM H), STEL alarm (STEL), TWA alarm (TWA), and OVER alarm (OVER).

Alarm type			First alarm (WARNING)	Second alarm (ALARM)	Third alarm (ALARM H)	STEL alarm (STEL)	TWA alarm (TWA)	OVER alarm (OVER)
Measured gas name	Hydrogen sulfide	Domestic	1.0 ppm	10.0 ppm	10.0 ppm	5.0 ppm	1.0 ppm	200.0 ppm
		Export	5.0 ppm	30.0 ppm	100.0 ppm	5.0 ppm	1.0 ppm	200.0 ppm



A gas alarm is triggered if the concentration of the detected gas reaches or exceeds the alarm setpoints shown in the following table. (Domestic models: Auto reset/Export models: Self-latching)

Gas alarm types include the first alarm (WARNING), second alarm (ALARM), third alarm (ALARM H), STEL alarm (STEL), cumulative alarm (A-1H) or TWA alarm (TWA)*, and OVER alarm (OVER).

Alarm type		First alarm (WARNING)	Second alarm (ALARM)	Third alarm (ALARM H)	STEL alarm (STEL)	Cumulative alarm (A-1H)	TWA alarm (TWA)	OVER alarm (OVER)	
Measured gas name	Carbon monoxide	Domestic	50 ppm	150 ppm	150 ppm	200 ppm	150 ppm	-	2,000 ppm
	Oxygen		18.0 %	18.0 %	25.0 %	-	-	-	40.0 %
	Carbon monoxide	Export	25 ppm	50 ppm	1,200 ppm	200 ppm	-	25 ppm	2,000 ppm
	Oxygen		18.0 %	18.0 %	25.0 %	-	-	-	40.0 %

*Domestic models: Cumulative alarm/Export models: TWA alarm

SO₂

A gas alarm is triggered if the concentration of the detected gas reaches or exceeds the alarm setpoints shown in the following table. (Self-latching)

Gas alarm types include the first alarm (WARNING), second alarm (ALARM), third alarm (ALARM H), STEL alarm (STEL), TWA alarm (TWA), and OVER alarm (OVER).

Alarm type		First alarm (WARNING)	Second alarm (ALARM)	Third alarm (ALARM H)	STEL alarm (STEL)	TWA alarm (TWA)	OVER alarm (OVER)	
Measured gas name	Sulfur dioxide	Domestic	2.00 ppm	5.00 ppm	5.00 ppm	5.00 ppm	2.00 ppm	100.00 ppm
		Export	2.00 ppm	5.00 ppm	100.00 ppm	5.00 ppm	2.00 ppm	100.00 ppm

NOTE

- ▶ The default settings for gas alarm setpoints are as shown in the tables above.
- ▶ The setting values for the alarm setpoints can be changed. (Refer to '6-5. Alarm setpoint setting (ALARM-P)'.)

4-2. Gas alarm activation

<Buzzer and alarm lamp patterns>

When a gas alarm occurs, the user will be alerted by the audible buzzer, flashing alarm lamp, and vibration.

The behavior differs depending on the type of alarm.

Alarm type	First alarm (WARNING)	Second alarm (ALARM)	Third alarm (ALARM H)	STEL alarm (STEL)	Cumulative alarm (A-1H)	TWA alarm (TWA)	OVER alarm (OVER)
Buzzer	Repeated alternating strong and weak beeps at about 1-second intervals: "Beep, beep"	Repeated alternating strong and weak blips at about 0.5-second intervals: "Blip, blip, blip, blip"	Repeated alternating strong and weak blips at about 0.5-second intervals: "Blip, blip, blip, blip"	Repeated alternating strong and weak beeps at about 1-second intervals: "Beep, beep"	Repeated alternating strong and weak beeps at about 1-second and 0.5-second intervals: "Beep, beep"	Repeated alternating strong and weak beeps at about 1-second intervals: "Beep, beep"	Repeated alternating strong and weak blips at about 0.5-second intervals: "Blip, blip, blip, blip"
Alarm lamp	Repeated flashing at about 1-second intervals	Repeated flashing at about 0.5-second intervals	Repeated flashing at about 0.5-second intervals	Repeated flashing at about 1-second intervals	Repeated alternating flashing at about 1-second and 0.5-second intervals	Repeated flashing at about 1-second intervals	Repeated flashing at about 0.5-second intervals
Vibration	The product will vibrate when an alarm occurs.						

<Gas alarm display>

When a gas alarm occurs, the alarm type is indicated on the LCD display and the corresponding gas concentration display blinks.

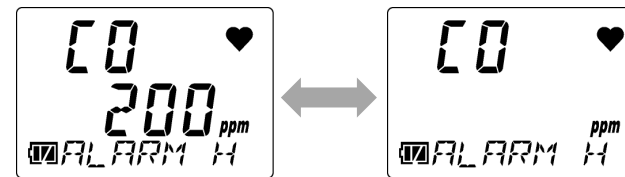

Display example: Carbon monoxide (CO) concentration: 200 ppm when the third alarm is triggered

NOTE

- ▶ If the gas detection range is exceeded (over scale), [OVER] appears on the LCD display, and [□□□□] will blink in the gas concentration display area.

**WARNING**

- A gas alarm indicates the presence of extreme danger. The user must take appropriate action after taking appropriate steps to ensure safety.

NOTE

- ▶ The alarm pattern can be checked in the alarm setpoint display in display mode. Note, however, that the gas concentration display will not blink in alarm tests. (Refer to '7-4. Performing alarm tests'.)
- ▶ Press the POWER/MODE button to reset the gas alarm.

4-3. Fault alarm activation

A fault alarm is triggered if an abnormality is detected in the product.

Fault alarm types include system, battery voltage, clock, sensor, and calibration abnormalities.



CAUTION

- If a fault alarm occurs, determine the cause and take appropriate action.
If the problem lies with the product and the fault occurs repeatedly, contact Riken Keiki immediately.

In the event of a fault alarm, the user will be alerted by the audible buzzer and flashing alarm lamp.

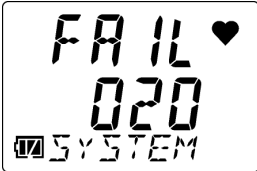
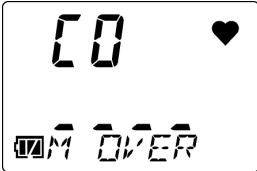
Alarm type	Fault alarm	M OVER alarm (M OVER)
Buzzer	Repeated intermittent beeps at about 1-second intervals: “Beep-beep, beep-beep”	Repeated intermittent beeps at about 1-second intervals: “Beep-beep, beep-beep”
Alarm lamp	Repeated flashing at about 1-second intervals	Repeated flashing at about 1-second intervals
LCD display	 Display example: System abnormality	 Display example: M OVER alarm

NOTE

- ▶ For more information on malfunctions (error messages), see ‘9. Troubleshooting’.
- ▶ The M OVER alarm (minus sensor failure) is an alarm triggered if the zero point falls below the minus side.
- ▶ Press the POWER/MODE button to reset the alarm.

4-4. Outside operating temperature range warning

An outside operating temperature range warning (temperature range error) will be issued if a product (other than the OX-04G) is used for 20 minutes or more outside the operating temperature range.

When a temperature range error occurs, either leave the product for five minutes or longer in the operating temperature range, or turn off the power of the main unit.

If an outside operating temperature range warning occurs, the user will be alerted by the audible buzzer and flashing alarm lamp.

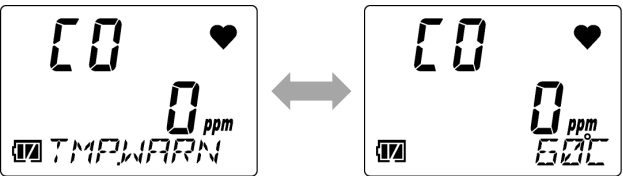
Alarm type	Outside operating temperature range warning
Buzzer	Repeated intermittent beeps at about 1-second intervals: "Beep"
Alarm lamp	Repeated flashing at about 1-second intervals
LCD display	 <p>Display example: Outside operating temperature range warning</p>

NOTE

- ▶ Press the POWER/MODE button to reset the alarm.
- ▶ The outside operating temperature range warning does not apply to the OX-04G.

5

Usage Instruciones

5-1. Usage note

Observe all usage precautions when using the product.

Failure to comply with these precautions may result in failure of the product or inability to perform normal gas measurement.

5-2. Preparing startup

Check the following before starting gas detection:

- Confirm that the protective film on the LCD display has been removed.
- Confirm adequate battery levels.
- Confirm that the filters inside the product are neither contaminated nor clogged.



WARNING

- Protective film is attached to the LCD display of the product at the time of shipping to protect it against scratching.

Be sure to peel off this protective film before using the product. Explosion-proofing cannot be guaranteed if the protective film is left attached.

5-3. Turning on the power

Turn the power on and start the product.

When the power is turned on, various information, including date and time and alarm setpoints, will be displayed in sequence, followed by the measurement mode screen.

1 Hold down the POWER/MODE button (for at least three seconds).

The alarm lamp lights up, and the buzzer blips once.

When the power is turned on, the entire LCD display lights up. The display changes automatically, as shown below.

NOTE

- ▶ When the lunch break ON/OFF (LUNCH) setting is ON, the next time the power is turned on, a confirmation screen displayed for 5 seconds will prompt you to decide whether to continue measurement by retaining the PEAK value or the cumulative value (TWA value) from the previous session. Press the POWER/MODE button to retain the value or the AIR button to reset. The value is retained if no action is taken within five seconds. (Refer to '6-6. Lunch break ON/OFF (LUNCH)'.)

The retained or reset gas concentration values are as follows:

OX-04G, OX-04: PEAK value

CO-04, CO-04 (C-), CX-04: Cumulative value or TWA value*, PEAK value (*Domestic models: Cumulative value/Export models: TWA value)

HS-04, SC-04 (SO₂): TWA value, PEAK value



Entire LCD display lights up.

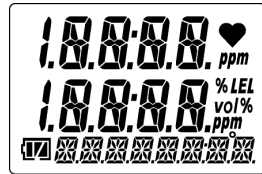

Calibration notification*1



Date and time



Battery level/ alarm pattern



Detection target gas name



The buzzer blips once, and the power turns on.

Full scale

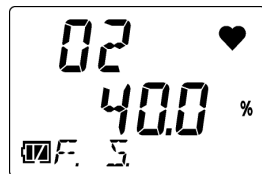

First gas alarm setpoint



Second gas alarm setpoint



Third gas alarm setpoint



Measurement mode



The buzzer blips twice, and the product switches to measurement mode.*2

*1 Domestic models: Calibration notification display/Export models: Calibration expiration display

*2 The buzzer does not sound when the key operation tone (KEY.TONE) setting in user mode is set to OFF.

CO **HS** **C-** **SO2** (Display example: CO-04)

Entire LCD display lights up.

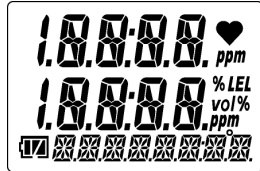

The buzzer blips once, and the power turns on.

Calibration notification*1

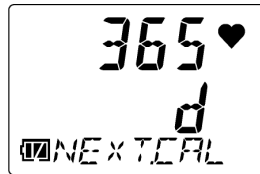

Date and time

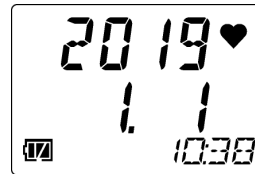

Battery level/ alarm pattern



Detection target gas name



Full scale



First gas alarm setpoint



Second gas alarm setpoint



Third gas alarm setpoint



STEL alarm setpoint



Cumulative/TWA alarm setpoint*2

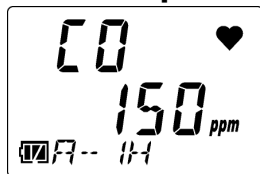

Measurement mode

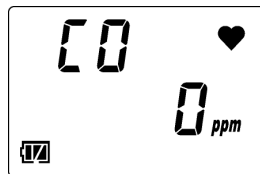

The buzzer blips twice, and the product switches to measurement mode.*3

*1 Domestic models: Calibration notification display/Export models: Calibration expiration display

*2 HS-04, SC-04 (SO2): TWA alarm setpoint

CO-04, CO-04 (C-): Domestic models: Cumulative alarm setpoint/Export models: TWA alarm setpoint

*3 The buzzer does not sound when the key operation tone (KEY.TONE) setting in user mode is set to OFF.



Entire LCD display lights up.

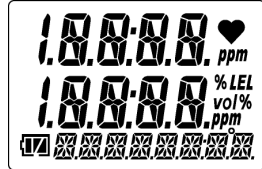

The buzzer blips once, and the power turns on.

Calibration notification*1

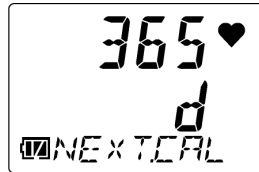

Date and time

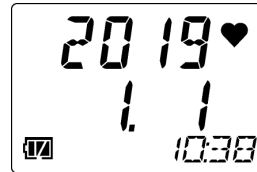

Battery level/ alarm pattern



Detection target gas name

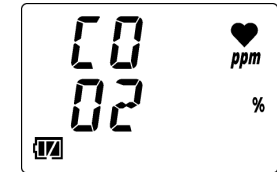

Full scale

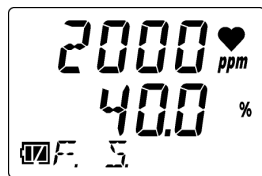

First gas alarm setpoint

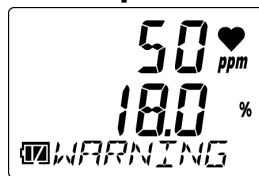

Second gas alarm setpoint

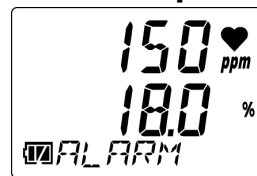

Third gas alarm setpoint

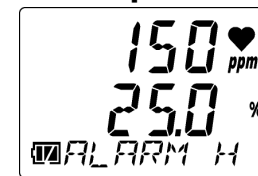

STEL alarm setpoint

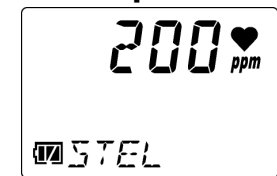

Cumulative/TWA alarm setpoint*2

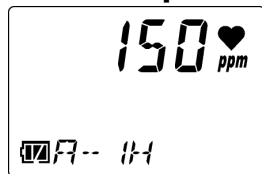

Measurement mode



The buzzer blips twice, and the product switches to measurement mode.*3

*1 Domestic models: Calibration notification display/Export models: Calibration expiration display

*2 Domestic models: Cumulative alarm setpoint/Export models: TWA alarm setpoint

*3 The buzzer does not sound when the key operation tone (KEY.TONE) setting in user mode is set to OFF.

<Basic operation flow>

After turning on the power, the product performs as follows when you press the AIR button or the POWER/MODE button.

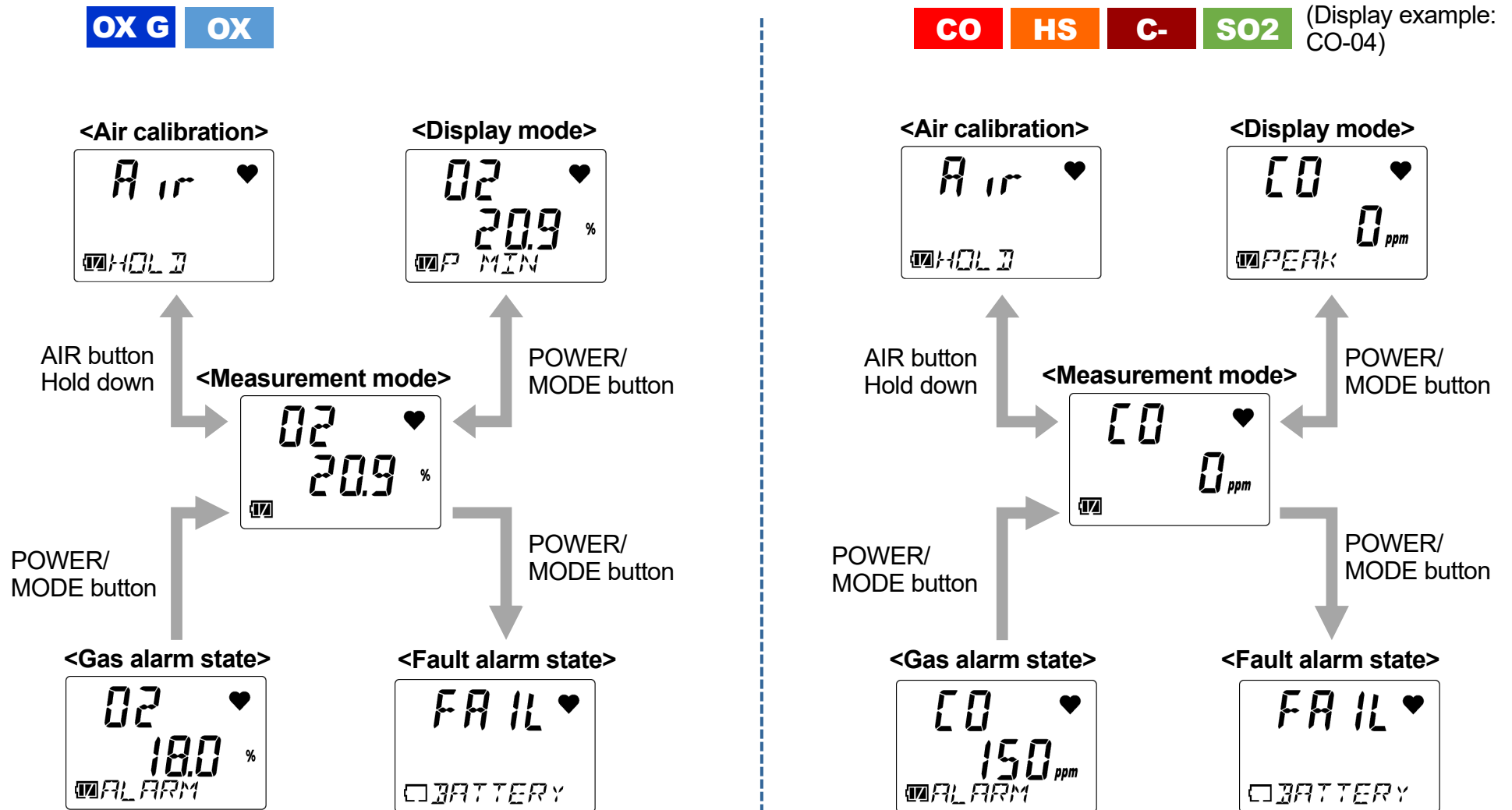

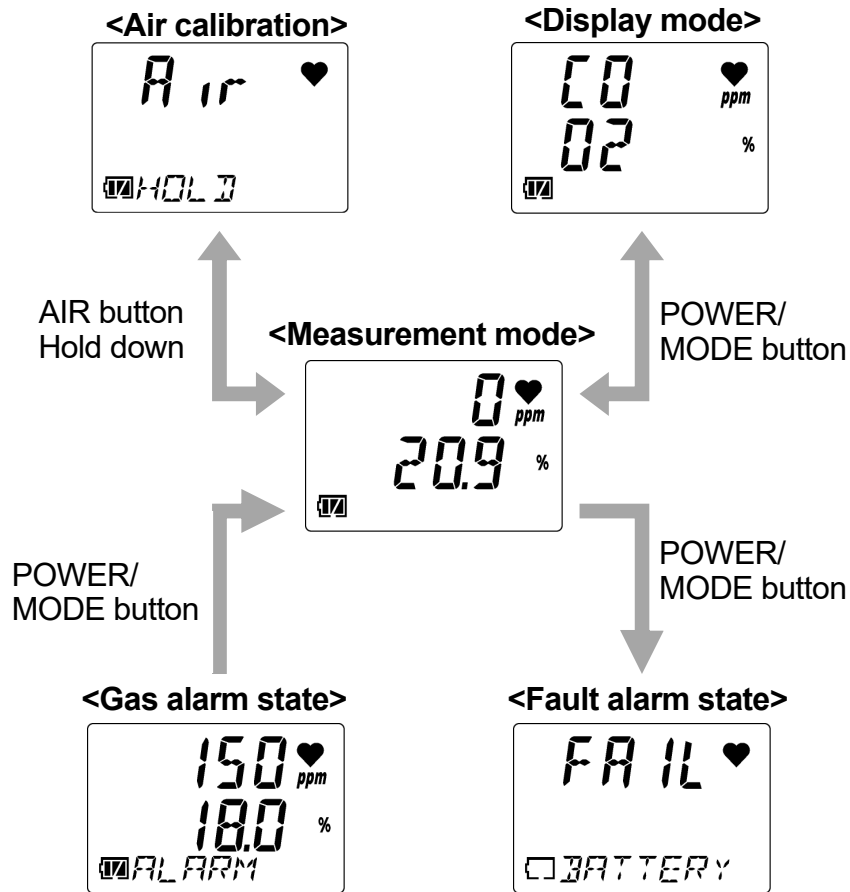

5-4. Performing air calibration

Perform air calibration before measuring gas concentration.

Air calibration refers to zero adjustment required to ensure accurate measurement of gas concentrations.

WARNING

- When air calibration is performed in the atmosphere, check the atmosphere for freshness before starting. The presence of interference gases will prevent proper air calibration. The presence of interference gases is also extremely dangerous because the product may not detect actual gas leaks correctly.

CAUTION **OX** **CO** **HS** **C-** **CX** **SO2**

- Perform air calibration in an environment that meets all of the following conditions:
 - Pressures, temperatures, and humidity levels are similar to pressures, temperatures, and humidity levels in the actual usage environment.
 - In fresh air
- Wait for the readout to stabilize before performing air calibration.
- If the temperature difference between the storage location and usage location is 15 °C or greater, turn on the power and allow the product to adjust to ambient conditions similar to those at the usage location for about 10 minutes. After this, air calibrate in fresh air before use.

**CAUTION OX G**

- Perform air calibration in an environment that meets all of the following conditions:
 - Pressures, temperatures, and humidity levels are similar to pressures, temperatures, and humidity levels in the actual usage environment.
 - In fresh air
- Wait for the readout to stabilize before performing air calibration.
- If the temperature difference between the storage location and usage location is 15 °C or greater, turn on the power and allow the product to adjust to ambient conditions similar to those at the usage location for about 30 minutes. After this, air calibrate in fresh air before use.

1 Hold down the AIR button in measurement mode.

Hold down until the buzzer blips once.
Air calibration starts.

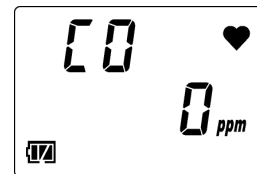
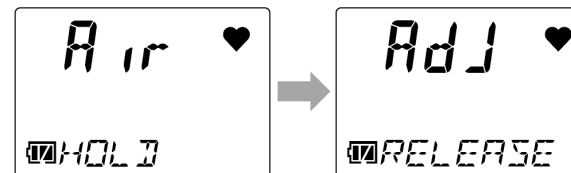
**2 Release the AIR button once the LCD display changes from [Air HOLD] to [AdJ RELEASE].**

The product automatically returns to measurement mode once air calibration has been successfully completed.

NOTE

- ▶ If air calibration fails, [FAIL AIR] will appear. Air calibration will not be performed. Press the POWER/MODE button to reset the fault alarm (calibration abnormality). Resetting the alarm displays the value before air calibration.
 - ▶ If the quick calibration function is enabled, you can perform quick calibration after successful air calibration in measurement mode. To perform quick calibration, hold down the AIR button and release the AIR button when [E-CAL] appears. (Refer to '6-11. Quick calibration time setting (E-CAL)'.)
-

5-5. Measuring gas concentration

The product automatically returns to measurement mode once air calibration has been successfully completed to measure the gas concentration.

The gas concentration will appear on the LCD display when measurement is complete.

If the gas concentration detected reaches the alarm setpoint at this time, a gas alarm is triggered. (Refer to '4-2. Gas alarm activation'.)

OX G OX

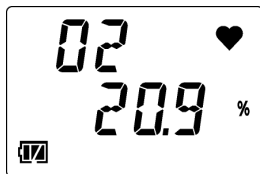

[O2] (oxygen) gas concentration display

CO HS C- SO2

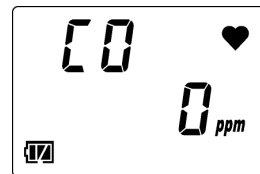

[CO] (carbon monoxide) gas concentration display

CX

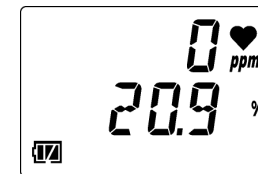

Upper row: [CO] (carbon monoxide) gas concentration display
Middle row: [O2] (oxygen) gas concentration display

WARNING

- A gas alarm indicates the presence of extreme danger. The user must take appropriate action after taking appropriate steps to ensure safety.
- Do not block the buzzer sound opening. Doing so will muffle or silence the audible warning.

NOTE

- ▶ When the confirmation beep has been set, the buzzer sounds at the set interval during measurement. (Refer to '6-7. Confirmation beep setting (BEEP)'.)
 - ▶ The gas concentration alarm setpoints can be checked in display mode. (Refer to '5-6. Checking the gas concentration, alarm setpoints, etc. (display mode)'.)
 - ▶ The LCD backlight lights up when you press the POWER/MODE button or the AIR button. The LCD backlight will go out after about 30 seconds if no operation is performed. Thirty seconds is the default setting. Change the LCD backlight lighting time in user mode. (Refer to '6-8. LCD lighting time setting (BL TIME)'.)
 - ▶ The LCD backlight turns on automatically if an alarm is triggered.
-

5-6. Checking the gas concentration, alarm setpoints, etc. (display mode)

Check measurement results.

Switch to display mode to check items like maximum concentration of gas detected, alarm setpoints, date and time, and temperature. You can also adjust the buzzer volume.

5-6-1. Procedure for displaying display mode

1 Press the POWER/MODE button in measurement mode.

The buzzer blips once, and the product switches to display mode.

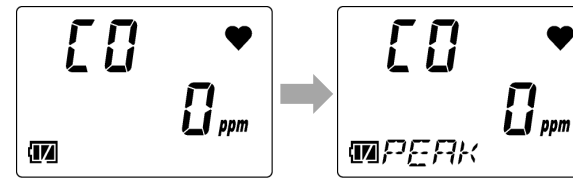

2 Press the POWER/MODE button to cycle through the items displayed.

Pressing the POWER/MODE button cycles through the displayed items.

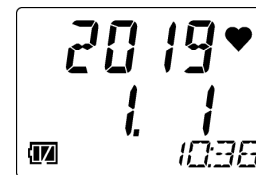





Display example:
With date and time
display selected









Press the POWER/MODE button in the buzzer volume setting screen to end display mode and return to measurement mode.

NOTE



- ▶ The product returns automatically to measurement mode if no button operations occur for about 20 seconds.
- ▶ When display mode item display setting (DISP.SET) is OFF, the buzzer volume setting is not displayed. To end display mode, press the POWER/MODE button in the alarm setpoint display screen. (Refer to ‘6-10. Display mode item display ON/OFF (DISP.SET)’.)

5-6-2. Items displayed in display mode

Display item	LCD display			Display contents
				
		<p>Display example: CO-04</p>		
Detection target gas name display	—	—		<p>Displays the name of the detection target gas. [CO] (carbon monoxide) is displayed in the upper row. [O2] (oxygen) is displayed in the middle row.</p>

<p>PEAK display (Lower limit value)</p>		<p>—</p>	<p>—</p>	<p>Displays the minimum gas concentration detected since the power was turned on. You can clear the PEAK value (lower limit value) while the PEAK display (lower limit value) is on by holding down the AIR button until [RELEASE] appears.</p> 
<p>PEAK display (Upper limit value)</p>				<p>Displays the maximum gas concentration (or minimum oxygen concentration of CX-04) detected since the power was turned on. You can clear the PEAK value while the PEAK display is on by holding down the AIR button until [RELEASE] appears.</p> <p>Display example) OX-04G</p> 
<p>STEL display</p>	<p>—</p>			<p>The time-weighted average for gas concentration over 15 minutes. The value is refreshed every 60 seconds.</p>

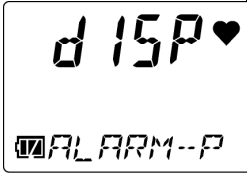
<p>Integrated display or TWA display</p>				<p>Displays the integrated gas concentration value or TWA value*.</p> <p>The integrated value (A-1H) is the time-weighted average for gas concentration over one hour. The elapsed time from the start of measurement is displayed in minute increments to the right of [A-1H].</p> <p>The TWA value (TWA) is the time-weighted average of the gas concentration over 8 hours per day or 40 hours per week. The value is refreshed every 60 seconds.</p> <p>*HS-04, SC-04(SO2):TWA display *CO-04, CO-04(C-), CX-04: Japan models: Integrated (A-1H) display/ Export models: TWA display</p>
<p>Date and time display</p>				<p>Displays the current time and date.</p> <p>Display example: January 1, 2019, 10:38</p>
<p>Temperature display</p>				<p>Displays the current temperature.</p> <p>The temperature indicated by the temperature display corresponds to the internal temperature of the product. This value differs from the actual ambient temperature.</p> <p>Display example: 24 degrees</p>

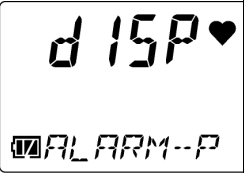
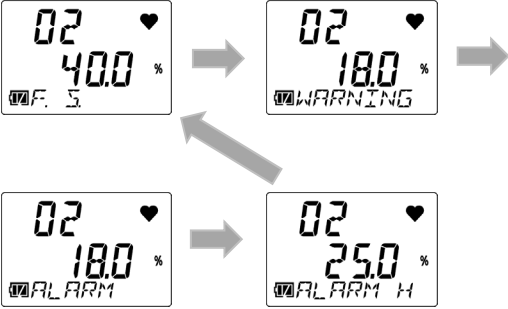
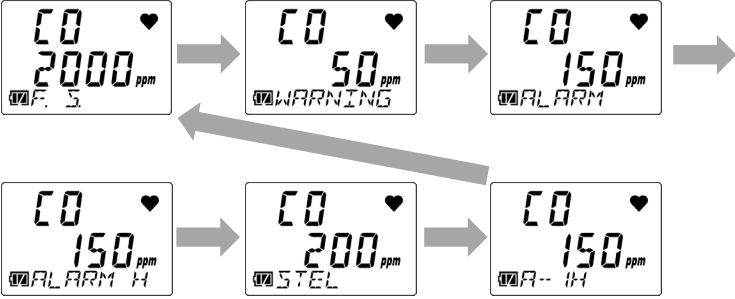
<p>Alarm setpoint display</p>				<p>Displays alarm setpoints. Pressing the AIR button lets you change the alarm setpoint display.</p> <p>【OX-04G,OX-04】 Pressing the AIR button cycles through the settings in the following order: [F.S.] (FULL SCALE) → [WARNING] → [ALARM] → [ALARM H].</p>  <p>【CO-04,HS-04,CO-04(C-),SC-04(SO2)】 Pressing the AIR button cycles through the settings in the following order: [F.S.] (FULL SCALE) → [WARNING] → [ALARM] → [ALARM H] → [STEL] → [A-1H] or [TWA]*.</p> 
--------------------------------------	---	---	--	--

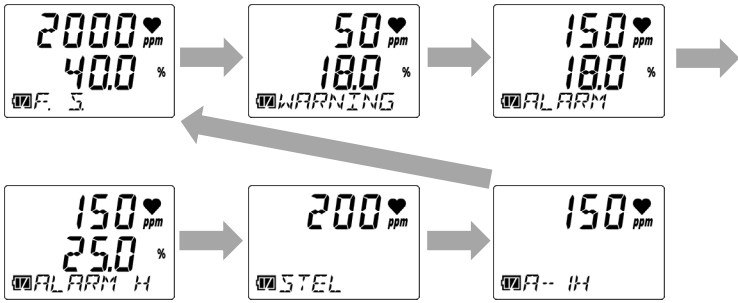
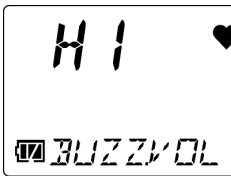
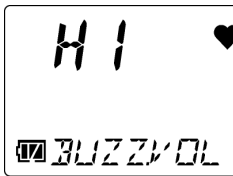
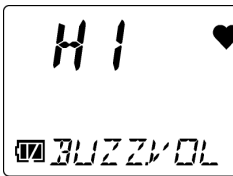
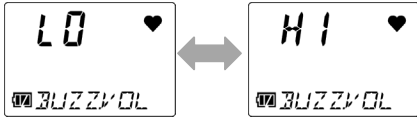
				<p>*HS-04,SC-04(SO2):TWA display *CO-04, CO-04(C-): Japan models: Integrated (A-1H) display/ Export models: TWA display</p> <p>【CX-04】 Pressing the AIR button cycles through the settings in the following order: [F.S.] (FULL SCALE) → [WARNING] → [ALARM] → [ALARM H] → [STEL] → [A-1H] or [TWA]*.</p>  <p>*Japan models: Integrated (A-1H) display/ Export models: TWA display</p>
<p>Buzzer volume setting</p>				<p>Displays the buzzer volume. Pressing the AIR button lets you change the buzzer volume. Pressing AIR button toggles the setting between [LO] (soft) and [HI] (loud).</p> 

NOTE

- ▶ By pressing the AIR button and the POWER/MODE button at the same time while displaying any of the alarm setpoints in the alarm setpoint display of display mode, you can test the relevant alarm. (Refer to '7-4. Performing alarm tests'.)

5-7. Turning off the power **CAUTION**

- If the concentration display does not return to [0ppm] (or [20.9%] for oxygen) when you turn the power off, allow the product to stand in fresh air. Confirm that the display returns to [0ppm] (or [20.9%] for oxygen) before turning the power off.

1 Hold down the POWER/MODE button (for at least three seconds).

Hold down until the buzzer blips three times.

[TURN OFF] appears on the LCD. The power turns off.

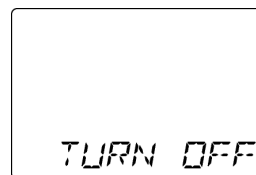

6

User Mode Settings

6-1. User mode setting procedure

Set the date and time, alarm setpoints, and other settings in user mode.

<Displaying the user mode setting screen>

Select the setting item in the user mode menu, then make the settings in the setting screen displayed.

1 Turn off the power.

Hold down the POWER/MODE button for at least three seconds to turn off the power.

2 Hold down the AIR button and the POWER/MODE button at the same time, then release them when the buzzer blips once.

The entire LCD display lights up, and the user mode menu appears.

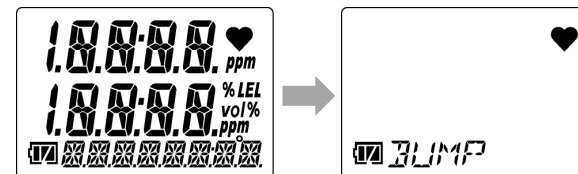

A password input screen will appear if a user mode password was set.

Press the AIR button for each digit to enter the password, then press the POWER/MODE button.

The user mode menu will appear when you press the POWER/MODE button after entering the 4th digit.

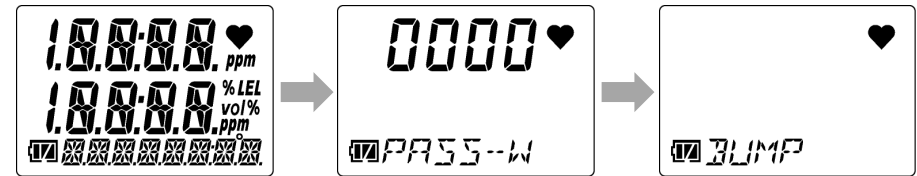

3 Press the AIR button several times to select the setting item.

Pressing AIR button cycles through user mode menu screens.

For information on user mode setting items, see '6-2. User mode setting items'.



Display example: With date and time setting (DATE) selected

4 Press the POWER/MODE button.

The setting screen appears.

Make the settings in each of the setting screens.

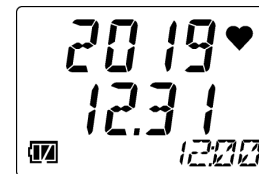

NOTE

- ▶ To display the menu one level higher while configuring settings, hold down the AIR button and the POWER/MODE button at the same time.
- ▶ The user mode password is the four-digit number set in user mode password setting (PASS-W). For information on the user mode password, see '6-13. User mode password setting (PASS-W)'.

<Ending user mode>

- 1 Once the settings are finished, press the AIR button several times to select [START], then press the POWER/MODE button.



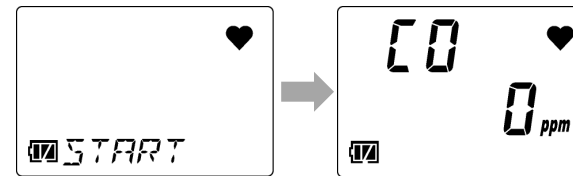

User mode ends. The product returns to measurement mode after performing the same operation as when the power is turned on.



**WARNING**





- Be sure to return to measurement mode after user mode settings are complete. The product will not return automatically to measurement mode if left in user mode.





6-2. User mode setting items

The following items can be set in user mode:

Item	LCD display	Details
Bump test (BUMP)		Perform a bump test (function check). The bump test is a test for checking whether the readings are within the acceptable range by introducing a calibration gas. For information on the bump test procedure, see '7-3. Performing bump tests'.
Calibration (GAS CAL)		Perform air calibration and AUTO calibration. For information on the calibration procedure, see '7-2. Performing calibration'.
Calibration expiration setting (CAL SET)		Toggle the calibration expiration ON/OFF for AUTO calibration, set the number of days for calibration expiration, and set the operation after calibration date expires. *Settings available on export models only
Bump test expiration setting (BUMP.SET)		Set the various conditions for bump testing, toggle the bump test expiration ON/OFF, set the bump test expiration date interval, and set the behavior after bump test expiration.

<p>Alarm setpoint setting (ALARM-P)</p>		<p>Set alarm setpoints*¹. You can also return the alarm setpoints to their default settings.</p> <p>*¹ The following alarm setpoints can be set:</p> <ul style="list-style-type: none"> ▪ OX-04G, OX-04: First to third alarm setpoints ▪ CO-04, CO-04 (C-), CX-04: First to third alarm setpoints, STEL alarm setpoint, cumulative alarm setpoint or TWA alarm setpoint*² ▪ HS-04, SO-04 (SO₂): First to third alarm setpoints, STEL alarm setpoint, TWA alarm setpoint <p>*² Domestic models: Cumulative alarm setpoint/Export models: TWA alarm setpoint</p>
<p>Lunch break ON/OFF (LUNCH)</p>		<p>Set the lunch break setting to ON/OFF.</p> <p>The lunch break function retains the gas concentration values*¹ from the last time the power was turned off and loads them to resume measurement the next time the power is turned on.</p> <p>*¹ The retained gas concentration values are as follows:</p> <ul style="list-style-type: none"> ▪ OX-04G, OX-04: PEAK value ▪ CO-04, CO-04 (C-), CX-04: Cumulative value or TWA value*², PEAK value ▪ HS-04, SO-04 (SO₂): TWA value, PEAK value <p>*² Domestic models: Cumulative value/Export models: TWA value</p>

<p>Confirmation beep setting (BEEP)</p>		<p>Toggle the confirmation beep ON/OFF, set its behavior, and set intervals. This function provides an audible indication of whether the product is operating normally. If the bump test expiration setting (BP.RMDR) or the calibration expiration setting (CAL.RMDR) is ON, you can have this function operate when the expiration date is reached.</p>
<p>LCD lighting time setting (BL TIME)</p>		<p>Set how long the LCD backlight remains on.</p>
<p>Key operation tone ON/OFF (KEY.TONE)</p>		<p>Set the key operation tone ON/OFF.</p>
<p>Display mode item display ON/OFF (DISP.SET)</p>		<p>Set the display ON/OFF for the items that can be set in display mode (buzzer volume setting).</p>

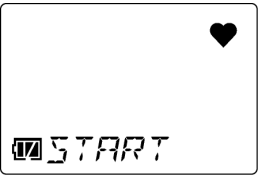
Quick calibration time setting (E-CAL)		<p>Set the time for quick calibration.</p> <p>The quick calibration function performs AUTO calibration after the introduction of the calibration gas by automatically counting down the calibration time set with the quick calibration time setting (E-CAL).</p>
Date and time setting (DATE)		<p>Set the date and time for the internal clock.</p>
User mode password setting (PASS-W)		<p>Set a password when transitioning to user mode.</p> <p>Set a password between 0000 and 9999.</p>
ROM/SUM display (ROM/SUM)		<p>This displays the program number and SUM value of the product.</p> <p>This is normally not set or adjusted by the user.</p>
Measurement start (START)		<p>Return to measurement mode.</p>

6-3. Calibration expiration setting (CAL SET)

The following items can be set in the calibration expiration setting (CAL SET). (Settings available on export models only)

Calibration expiration setting (CAL SET)

- Calibration expiration ON/OFF (CAL.RMDR)
- Calibration expiration date interval (CAL.INT)
- Setting operation after calibration date expires (CAL.EXPD)
- ESCAPE

NOTE

- ▶ To display the menu one level higher while configuring settings, hold down the AIR button and the POWER/MODE button at the same time.
- ▶ To end the calibration expiration settings (CAL SET), press the AIR button several times to select [ESCAPE], then press the POWER/MODE button. The display returns to the user mode menu.

6-3-1. Calibration expiration ON/OFF (CAL.RMDR)

This toggles calibration expiration ON/OFF for AUTO calibration.

If calibration expiration is set to ON, when the expiration date set in calibration expiration date interval (CAL.INT) is reached, the operation set in setting operation after calibration date expires (CAL.EXPD) is performed.

The default setting is ON (for export models).

- 1 Press the AIR button several times in user mode to select [CAL SET], then press the POWER/MODE button.**
- 2 Select [CAL.RMDR], then press the POWER/MODE button.**
- 3 Press the AIR button several times to select [ON] or [OFF], then press the POWER/MODE button.**

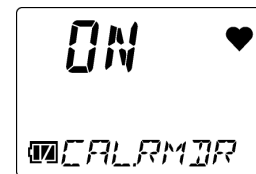
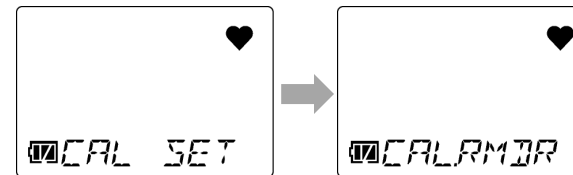

[END] appears once the settings are complete. The display returns to the [CAL.RMDR] screen.

6-3-2. Calibration expiration date interval (CAL.INT)

This sets the number of days (1 to 1,000 days) for the calibration expiration for AUTO calibration.
The default setting is 90 days.

- 1 Press the AIR button several times in user mode to select [CAL SET], then press the POWER/MODE button.**
- 2 Press the AIR button several times to select [CAL.INT], then press the POWER/MODE button.**
- 3 Press the AIR button several times to select the number of days for the calibration expiration, then press the POWER/MODE button.**

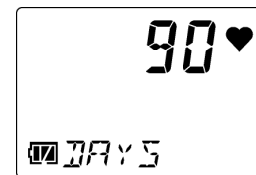
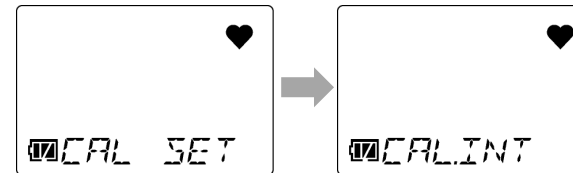

[END] appears once the settings are complete. The display returns to the [CAL.INT] screen.

6-3-3. Setting operation after calibration date expires (CAL.EXPD)

Set the operation performed when the calibration date for AUTO calibration expires.

Select one of the following:

- CONFIRM: The behavior differs depending on the operation.
Press the AIR button to proceed to measurement mode or press the POWER/MODE button to proceed to AUTO calibration.
- CANT.USE: Measurement mode is not available. Press the POWER/MODE button to proceed to AUTO calibration. Alternatively, the product will automatically proceed to AUTO calibration after about six seconds.
- NONE: The behavior differs depending on the operation.
If the product indicates that the expiration date has been reached, press the POWER/MODE button to proceed to AUTO calibration. If you do nothing, the product will proceed to measurement mode after about six seconds.

The default setting is CONFIRM.

- 1 Press the AIR button several times in user mode to select [CAL SET], then press the POWER/MODE button.**
- 2 Press the AIR button several times to select [CAL.EXPD], then press the POWER/MODE button.**

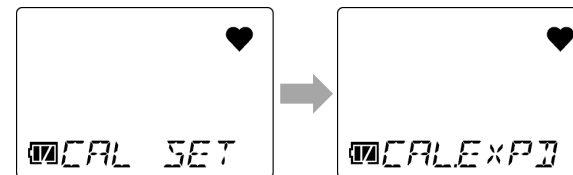

- 3 Press the AIR button several times to select the operation after calibration date expires, then press the POWER/MODE button.**

Select [CONFIRM], [CANT.USE], or [NONE].

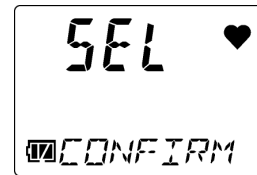

[END] appears once the settings are complete. The display returns to the [CAL.EXPD] screen.

6-4. Bump test expiration setting (BUMP.SET)

The following items can be set in the bump test expiration setting (BUMP.SET):

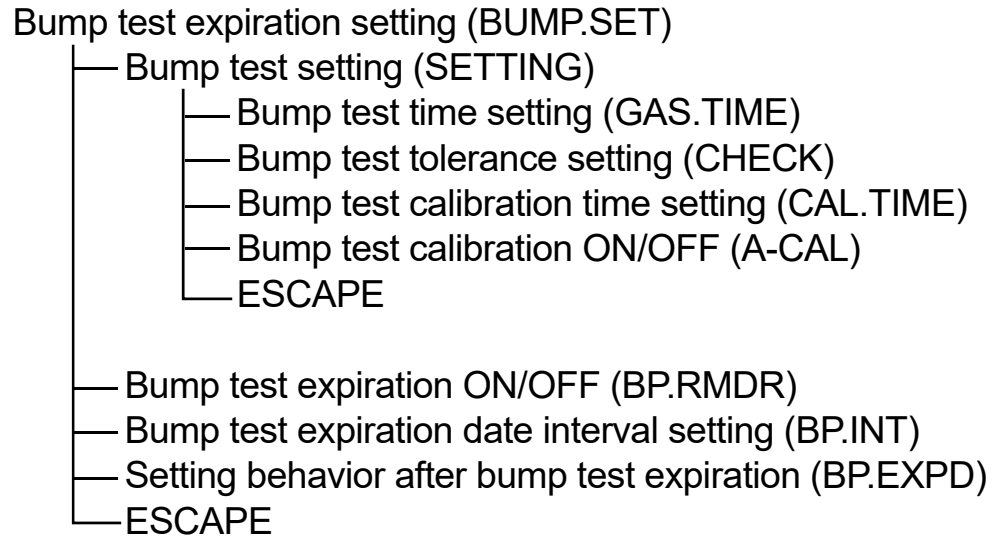

NOTE

- ▶ To display the menu one level higher while configuring settings, hold down the AIR button and the POWER/MODE button at the same time.
- ▶ To end the bump test expiration settings (BUMP.SET), press the AIR button several times to select [ESCAPE], then press the POWER/MODE button. The display returns to the user mode menu.
- ▶ To end the bump test settings (SETTING), press the AIR button several times to select [ESCAPE], then press the POWER/MODE button. The display returns to the bump test expiration setting (BUMP.SET) menu.

6-4-1. Bump test setting (SETTING)

Set the bump test time, bump test tolerance, calibration time, and ON/OFF for calibration after a bump test failure.

<Bump test time setting (GAS.TIME)>

This lets you set the time at which the calibration gas is introduced when performing a bump test.

Select from 30, 45, 60, and 90 seconds. The default setting is 30 seconds.

- 1 Press the AIR button several times in user mode to select [BUMP.SET], then press the POWER/MODE button.
- 2 Select [SETTING], then press the POWER/MODE button.
- 3 Select [GAS.TIME], then press the POWER/MODE button.
- 4 Press the AIR button several times to select the time for the bump test, then press the POWER/MODE button.
Select [30], [45], [60], or [90].



[END] appears once the settings are complete. The display returns to the [GAS.TIME] screen.

<Bump test tolerance setting (CHECK)>

Set the bump test tolerance (threshold for determining pass or failure for the bump test).

Select from 10, 20, 30, 40, and 50 %. The default setting is 50 %.

- 1 Press the AIR button several times in user mode to select [BUMP.SET], then press the POWER/MODE button.**
- 2 Select [SETTING], then press the POWER/MODE button.**
- 3 Press the AIR button several times to select [CHECK], then press the POWER/MODE button.**
- 4 Press the AIR button several times to select the bump tolerance, then press the POWER/MODE button.**
Select [10], [20], [30], [40], or [50].

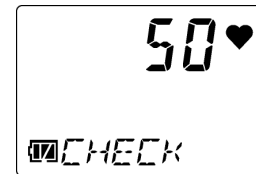

[END] appears once the settings are complete. The display returns to the [CHECK] screen.

<Bump test calibration time setting (CAL.TIME)>

Set the time for calibration after a bump test fails.

Select from 60, 90, and 120 seconds. The default setting is 60 seconds.

- 1 Press the AIR button several times in user mode to select [BUMP.SET], then press the POWER/MODE button.**
- 2 Select [SETTING], then press the POWER/MODE button.**
- 3 Press the AIR button several times to select [CAL.TIME], then press the POWER/MODE button.**
- 4 Press the AIR button several times to select the calibration time after a bump test, then press the POWER/MODE button.**
Select [60], [90], or [120].



[END] appears once the settings are complete. The display returns to the [CAL.TIME] screen.

<Bump test calibration ON/OFF (A-CAL)>

Set whether calibration is to be performed after a bump test fails.

If this is set to ON, calibration (AUTO calibration) is performed automatically when a bump test fails.

The default setting is ON.

- 1 Press the AIR button several times in user mode to select [BUMP.SET], then press the POWER/MODE button.**
- 2 Select [SETTING], then press the POWER/MODE button.**
- 3 Press the AIR button several times to select [A-CAL], then press the POWER/MODE button.**
- 4 Press the AIR button several times to select [ON] or [OFF], then press the POWER/MODE button.**

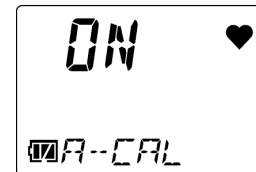

[END] appears once the settings are complete. The display returns to the [A- CAL] screen.

6-4-2. Bump test expiration ON/OFF (BP.RMDR)

This toggles the bump test expiration ON/OFF.

If the setting is ON, the operation set in setting behavior after bump test expiration (BP.EXPD) is performed when the expiration date set in bump test expiration date interval setting (BP.INT) is reached.

The default setting is OFF.

- 1 Press the AIR button several times in user mode to select [BUMP.SET], then press the POWER/MODE button.**
- 2 Press the AIR button several times to select [BP.RMDR], then press the POWER/MODE button.**
- 3 Press the AIR button several times to select [ON] or [OFF], then press the POWER/MODE button.**

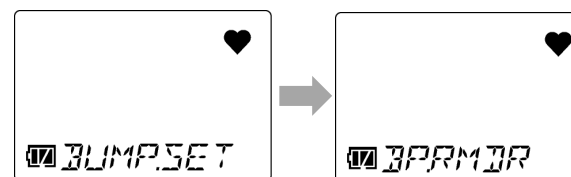

[END] appears once the settings are complete. The display returns to the [BP.RMDR] screen.

6-4-3. Bump test expiration date interval setting (BP.INT)

This sets the number of days (0 to 30 days) for bump test expiration.
The default setting is 30 days.

- 1 Press the AIR button several times in user mode to select [BUMP.SET], then press the POWER/MODE button.**
- 2 Press the AIR button several times to select [BP.INT], then press the POWER/MODE button.**
- 3 Press the AIR button several times to set the bump test expiration date interval, then press the POWER/MODE button**

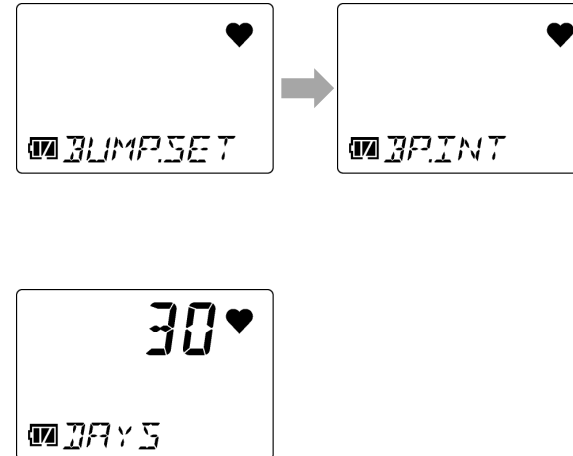

[END] appears once the settings are complete. The display returns to the [BP.INT] screen.

6-4-4. Setting behavior after bump test expiration (BP.EXPD)

This selects the behavior after the bump test expiration date.

Select one of the following:

- CONFIRM: The behavior differs depending on the operation.
Press the AIR button to proceed to measurement mode or press the POWER/MODE button to proceed to the bump test.
- CANT.USE: Measurement mode is not available. Press the POWER/MODE button to proceed to the bump test.
If you do nothing, the product will automatically proceed to the bump test after about six seconds.
- NONE: The behavior differs depending on the operation.
If the product indicates that the expiration date has been reached, press the POWER/MODE button to proceed to the bump test. If you do nothing, the product will proceed to measurement mode after about six seconds.

The default setting is CONFIRM.

- 1 Press the AIR button several times in user mode to select [BUMP.SET], then press the POWER/MODE button.**
- 2 Press the AIR button several times to select [BP.EXPD], then press the POWER/MODE button.**

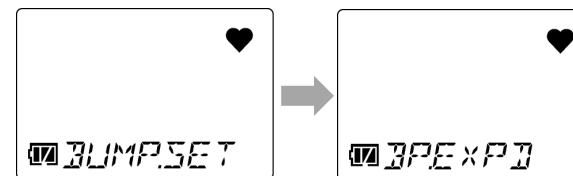

- 3 Press the AIR button several times to select the behavior after expiration, then press the POWER/MODE button.**

Select [CONFIRM], [CANT.USE], or [NONE].

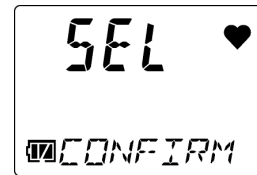

[END] appears once the settings are complete. The display returns to the [BP.EXPD] screen.

6-5. Alarm setpoint setting (ALARM-P)

This is used to set alarm setpoints. You can also return the alarm setpoints to their default settings. The following items can be set in the alarm setpoint setting (ALARM-P):

- Alarm setpoint setting (ALARM-P)
 - Alarm setpoint setting (ALARM-P)
 - Resetting alarm setpoints (DEF.ALMP)
 - ESCAPE

NOTE

- ▶ To display the menu one level higher while configuring settings, hold down the AIR button and the POWER/MODE button at the same time.
 - ▶ To end the alarm setpoint settings (ALARM-P), press the AIR button several times to select [ESCAPE], then press the POWER/MODE button. The display returns to the user mode menu.
-

6-5-1. Alarm setpoint setting (ALARM-P)

<Alarm setpoint setting range>

Alarm setpoints can be set to the specified number of digits.

OX G OX

Detection target gas	1 digit	First/second alarm		Third alarm	
		Lower limit	Upper limit	Lower limit	Upper limit
Oxygen (O ₂)	0.1 %	0.0 %	20.0 %	21.8 %	40.0 %

CO C-

Detection target gas	1 digit	Lower limit	Upper limit
Carbon monoxide (CO)	1 ppm (0 to 300 ppm) 10 ppm (300 to 2,000 ppm)	20 ppm	2,000 ppm

HS

Detection target gas	1 digit	Lower limit	Upper limit
Hydrogen sulfide (H ₂ S)	0.1 ppm (0.0 to 30.0 ppm) 1.0 ppm (30.0 to 200.0 ppm)	1.0 ppm	200.0 ppm

CX

Detection target gas	1 digit	Lower limit	Upper limit
Carbon monoxide (CO)	1 ppm (0 to 300 ppm) 10 ppm (300 to 2,000 ppm)	20 ppm	2,000 ppm

Detection target gas	1 digit	First/second alarm		Third alarm	
		Lower limit	Upper limit	Lower limit	Upper limit
Oxygen (O ₂)	0.1 %	0.0 %	20.0 %	21.8 %	40.0 %

SO2

Detection target gas	1 digit	Lower limit	Upper limit
Sulfur dioxide (SO ₂)	0.05 ppm (0.00 to 100.00 ppm)	1.00 ppm	100.00 ppm

<Alarm setpoint setting> **OX G** **OX** **CO** **HS** **C-** **SO2** (Display example: CO-04)

Set the alarm setpoints as follows: First alarm \leq second alarm \leq third alarm (first alarm \geq second alarm for oxygen [O₂]).

- 1 Press the AIR button several times in user mode to select [ALARM-P], then press the POWER/MODE button.



- 2 Confirm the name of the target gas, then press the POWER/MODE button.



- 3 Press the POWER/MODE button several times to select the alarm type.

Alarm setpoints are displayed in the following order:

OX-04G, OX-04:

First alarm setpoint → Second alarm setpoint →
Third alarm setpoint

CO-04, CO-04 (C-):

First alarm setpoint → Second alarm setpoint →
Third alarm setpoint → STEL alarm setpoint →
Cumulative alarm setpoint or TWA alarm setpoint*



*Domestic models: Cumulative alarm setpoint/
Export models: TWA alarm setpoint

HS-04, SC-04 (SO₂):

First alarm setpoint → Second alarm setpoint →

Third alarm setpoint → STEL alarm setpoint →

TWA alarm setpoint

- 4 Press the AIR button several times to set the value for the alarm setpoint, then press the POWER/MODE button.**

Set each alarm setpoint within the valid range of setpoints.

Furthermore, set as follows: First alarm ≤ second alarm ≤ third alarm (first alarm ≥ second alarm for oxygen [O₂]).

[END] appears once the settings are complete. The display returns to the [ALARM-P] (target gas display) screen.



<Alarm setpoint setting> 

Set the alarm setpoints as follows: First alarm \leq second alarm \leq third alarm (first alarm \geq second alarm for oxygen [O₂]).

- 1 Press the AIR button several times in user mode to select [ALARM-P], then press the POWER/MODE button.**



- 2 Press the AIR button several times to select the target gas, then press the POWER/MODE button.**

Select either [CO] or [O₂].

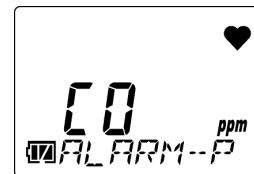

- 3 Press the POWER/MODE button several times to select the alarm type.**

Alarm setpoints are displayed in the following order:

For [CO] (carbon monoxide):

First alarm setpoint → Second alarm setpoint →

Third alarm setpoint → STEL alarm setpoint →

Cumulative alarm setpoint or TWA alarm setpoint*

*Domestic models: Cumulative alarm

setpoint/Export models: TWA alarm setpoint



For [O₂] (oxygen):

First alarm setpoint → Second alarm setpoint →

Third alarm setpoint

- 4 Press the AIR button several times to set the value for the alarm setpoint, then press the POWER/MODE button.**

Set each alarm setpoint within the valid range of setpoints.

Furthermore, set as follows: First alarm \leq second alarm \leq third alarm (first alarm \geq second alarm for oxygen [O₂]).

[END] appears once the settings are complete. The display returns to the [ALARM-P] (target gas display) screen.



6-5-2. Resetting alarm setpoints (DEF.ALMP)

This restores alarm setpoints to their default settings.

For more information on default settings for alarm setpoints, see '4-1. Gas alarm types and alarm setpoints'.

1 Press the AIR button several times in user mode to select [ALARM-P], then press the POWER/MODE button.

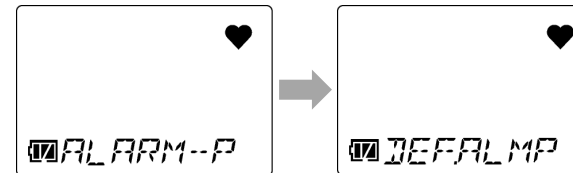

2 Press the AIR button several times to select [DEF.ALMP], then press the POWER/MODE button.

3 Press the POWER/MODE button.

To cancel the reset, press the AIR button.

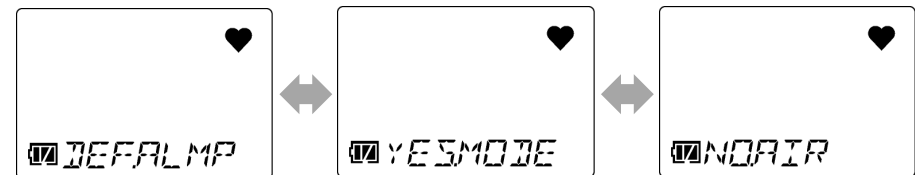

4 Press the POWER/MODE button when the reset confirmation screen appears.

To cancel the reset, press the AIR button.

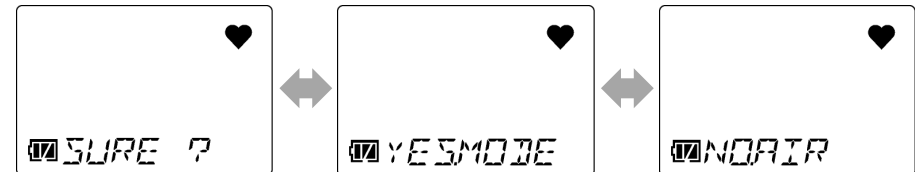

[END] appears once the settings are complete. The display returns to the [DEF.ALMP] screen.

6-6. Lunch break ON/OFF (LUNCH)

Set the lunch break setting to ON/OFF.

The lunch break function retains the gas concentration values from the last time the power was turned off and loads them to resume measurement the next time the power is turned on.

When the lunch break setting is ON, a confirmation screen will appear the next time the power is turned on and prompt you to decide whether to retain the gas concentration values from the last time the power was turned off and resume measurement or to reset the values from the last time the power was turned off.

The default setting is OFF.

The retained gas concentration values are as follows:

- OX-04G, OX-04: PEAK value
- CO-04, CO-04 (C-), CX-04: Cumulative value or TWA value*, PEAK value
- HS-04, SC-04 (SO₂): TWA value, PEAK value

*Domestic models: Cumulative value/Export models: TWA value

1 Press the AIR button several times in user mode to select [LUNCH], then press the POWER/MODE button.



2 Press the AIR button several times to select [ON] or [OFF], then press the POWER/MODE button.

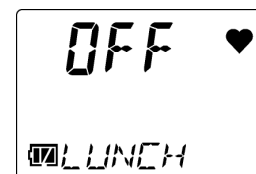

[END] appears once the settings are complete. The display returns to the user mode menu.

6-7. Confirmation beep setting (BEEP)

This function provides an audible indication of whether the product is operating normally while measuring gas concentrations.

The following items can be set in the confirmation beep setting (BEEP):

- Confirmation beep setting (BEEP)
 - └ Beep operation setting (BEEP.SEL)
 - └ Beep interval setting (BEEP.INT)
 - └ ESCAPE

NOTE

- ▶ To display the menu one level higher while configuring settings, hold down the AIR button and the POWER/MODE button at the same time.
- ▶ To end the confirmation beep settings (BEEP), press the AIR button several times to select [ESCAPE], then press the POWER/MODE button. The display returns to the user mode menu.

6-7-1. Beep operation setting (BEEP.SEL)

Set the confirmation beep operation.

Select one of the following. The default setting is OFF.

- OFF: The confirmation beep is OFF.
- LED: The alarm lamp lights up.
- BUZZER: The buzzer sounds.
- LED+BUZ: The alarm lamp lights up, and the buzzer sounds.
- BMP/CAL: If the bump test expiration setting or the calibration expiration setting is ON, the alarm lamp lights up when the expiration date is reached.

- 1 Press the AIR button several times in user mode to select [BEEP], then press the POWER/MODE button.**
- 2 Select [BEEP.SEL], then press the POWER/MODE button.**
- 3 Press the AIR button several times to select the behavior of the confirmation beep, then press the POWER/MODE button.**
Select [OFF], [LED], [BUZZER], [LED+BUZ], or [BMP/CAL].

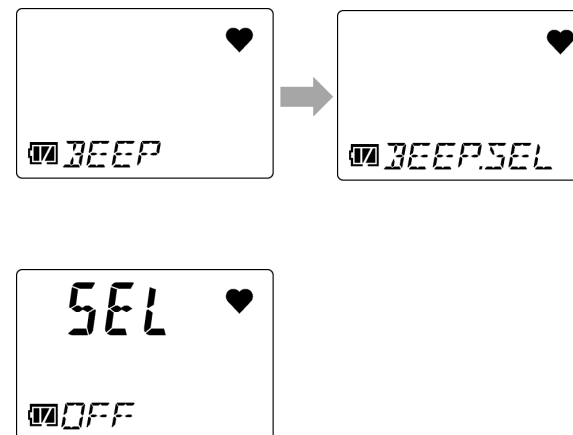

[END] appears once the settings are complete. The display returns to the [BEEP.SEL] screen.

6-7-2. Beep interval setting (BEEP.INT)

Set the interval between confirmation beeps.

Set the interval to 0.5 minutes or to a value from 1 to 99 minutes. The default setting is 5 minutes.

- 1 Press the AIR button several times in user mode to select [BEEP], then press the POWER/MODE button.**
- 2 Press the AIR button several times to select [BEEP.INT], then press the POWER/MODE button.**
- 3 Press the AIR button several times to set the interval for the confirmation beep, then press the POWER/MODE button.**

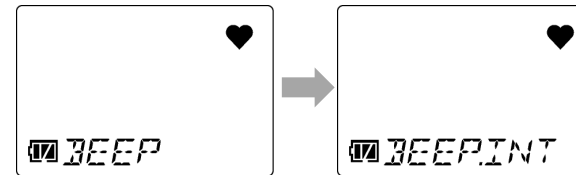

[END] appears once the settings are complete. The display returns to the [BEEP.INT] screen.

6-8. LCD lighting time setting (BL TIME)

Set the duration for which the LCD backlight remains lit.

Set the LCD lighting time to OFF or to a value from 1 to 255 seconds. The default setting is 30 seconds.

- 1 Press the AIR button several times in user mode to select [BL TIME], then press the POWER/MODE button.**

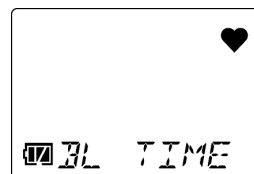

- 2 Press the AIR button several times to set the LCD lighting time, then press the POWER/MODE button.**

You can set to [OFF] or to a value from [1] to [255].

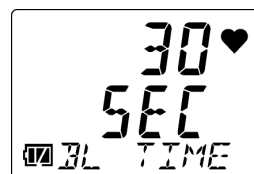

[END] appears once the settings are complete. The display returns to the user mode menu.

6-9. Key operation tone ON/OFF (KEY.TONE)

Select ON/OFF for the key operation tone when you press the AIR button or the POWER/MODE button.

If this setting is set to ON, the key operation tone will sound when you press the AIR button or the POWER/MODE button.

The default setting is ON.

- 1 Press the AIR button several times in user mode to select [KEY.TONE], then press the POWER/MODE button.**



- 2 Press the AIR button several times to select [ON] or [OFF], then press the POWER/MODE button.**



[END] appears once the settings are complete. The display returns to the user mode menu.

6-10. Display mode item display ON/OFF (DISP.SET)

You can select whether to display or hide items that can be set in display mode (buzzer volume setting). If this is set to OFF, the items that can be set in display mode (buzzer volume setting) will not be displayed. The default setting is ON.

- 1 Press the AIR button several times in user mode to select [DISP.SET], then press the POWER/MODE button.



- 2 Press the AIR button several times to select [ON] or [OFF], then press the POWER/MODE button.

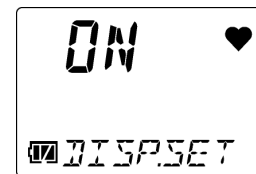

[END] appears once the settings are complete. The display returns to the user mode menu.

6-11. Quick calibration time setting (E-CAL)

The quick calibration function performs AUTO calibration after the introduction of the calibration gas by automatically counting down the calibration time set with the quick calibration time setting (E-CAL).

Select OFF or a time from 1 to 180 seconds for quick calibration time.

The default settings are as follows:

- For CO-04, CO-04 (C-), CX-04 domestic models: 60 seconds
- For models other than the above: OFF

1 Press the AIR button several times in user mode to select [E-CAL], then press the POWER/MODE button.



2 Press the AIR button several times to set the time for quick calibration, then press the POWER/MODE button.



Set to [OFF] or to a value from [1] to [180].

[END] appears once the settings are complete. The display returns to the user mode menu.

NOTE

- ▶ The standard calibration time for AUTO calibration is 60 seconds. While AUTO calibration will finish faster if you set this to a lesser value, doing so may affect the precision of the readings.
- ▶ When quick calibration is enabled, the AUTO calibration menu display changes from [A-CAL] to [E-CAL]. (Refer to '7-2-4. Performing AUTO calibration'.)

6-12. Date and time setting (DATE)

Set the date and time for the internal clock.

- 1 Press the AIR button several times in user mode to select [DATE], then press the POWER/MODE button.**



- 2 Press the POWER/MODE button to select each of Year, Month, Day, Hour, and Minutes, then press the AIR button to set the date and time.** Pressing the POWER/MODE button cycles through the items in the following order: Year → Month → Day → Hour → Minutes.

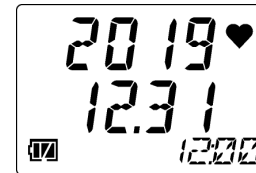

- 3 When the settings are complete, select [Minutes], then press the POWER/MODE button.**

[END] appears once the settings are complete. The display returns to the user mode menu.

6-13. User mode password setting (PASS-W)

Set a password when transitioning to user mode.

If the setting is ON, access to user mode is password-protected and a password input screen is displayed when the user seeks to enter user mode.

The default setting is OFF.

If this is set to ON, set a four-digit password between 0000 and 9999. The default setting is 0000.

- 1 Press the AIR button several times in user mode to select [PASS-W], then press the POWER/MODE button.**

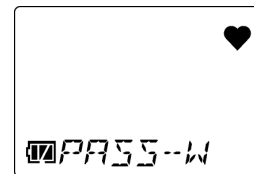

- 2 Press the AIR button several times to select [ON] or [OFF] for the password setting, then press the POWER/MODE button.**

If [ON] is selected, a password setting screen appears.

If [OFF] is selected, [END] appears. The display returns to the user mode menu.



- 3 Press the AIR button several times to set the password one digit at a time, then press the POWER/MODE button.**

Set the password one digit at a time, starting from the left. Select a number with the AIR button, then press the POWER/MODE button to move to the next digit to the right.

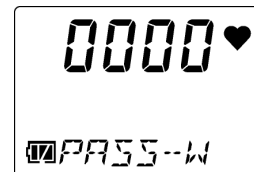

When you have set the 4th digit and press the POWER/MODE button, [END] appears. The display returns to the user mode menu.

6-14. ROM/SUM display (ROM/SUM)

This displays the program number and SUM value of the product.

This is normally not set or adjusted by the user.

- 1 Press the AIR button several times in user mode to select [ROM/SUM], then press the POWER/MODE button.**
- 2 Check the program number and the SUM value, then press the POWER/MODE button.**

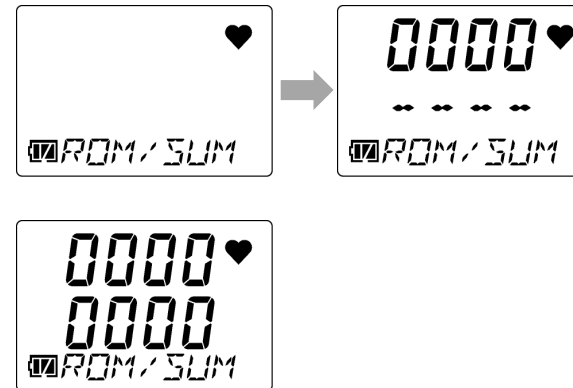

[END] appears. The display returns to the user mode menu.

7

Maintenance

The product is an important safety and disaster-prevention device.

Perform product maintenance at regular intervals to ensure performance and to improve disaster-prevention and safety reliability.

7-1. Maintenance intervals and maintenance items

Maintain the following items at regular intervals:

- Daily maintenance: Perform maintenance before commencing work.
- Monthly maintenance: Perform alarm tests monthly. (Refer to '7-4. Performing alarm tests'.)
- Regular maintenance: Perform maintenance at least once a year (ideally, at least once every six months).

Maintenance item	Maintenance details	Daily maintenance	Monthly maintenance	Regular maintenance
Battery level	Check to confirm that battery levels are adequate.	○	○	○
Concentration display	Check to confirm that the concentration readout is [0ppm] ([20.9%] for oxygen) by measuring fresh air. If the readout is not [0ppm] ([20.9%] for oxygen), check to confirm that no interference gases are present, then perform air calibration.	○	○	○
Main unit operation	Check to confirm that no fault alarm is displayed on the LCD display.	○	○	○

Maintenance item	Maintenance details	Daily maintenance	Monthly maintenance	Regular maintenance
Filters	Check to confirm that the filters are not dirty.	○	○	○
Alarm test	Perform a test. Check to confirm that the alarm lamp, buzzer, and vibration are functioning normally.	—	○	○
Calibration	Perform calibration using a calibration gas.	—	—	○
Gas alarm check	Check the gas alarm using a calibration gas.	—	—	○



WARNING

- If you encounter a product abnormality, contact Riken Keiki immediately.

NOTE

- ▶ Calibration requires dedicated tools and the preparation of a calibration gas. Contact Riken Keiki before performing calibration.
- ▶ The built-in sensor has an expiration date. Replace periodically.
- ▶ The sensor needs to be replaced if you encounter symptoms like failure to restore readings after air calibration or fluctuating readings when performing calibration. Contact Riken Keiki for replacement.

7-2. Performing calibration

The product can be calibrated using AUTO calibration with preset gas concentrations, in addition to air calibration performed in the atmosphere.

Calibration requires dedicated tools and a calibration gas. Contact Riken Keiki before performing calibration.

7-2-1. Preparation for calibration

Prepare the following equipment and calibration gases, then connect to this product:

<Required equipment>

- Gas set
(Gas sampling bag, tube (length not exceeding 1 m), pump with flow adjuster function (a pump, flow gauge, and needle can also be used.))
- Calibration adapter
- Stopwatch

<Calibration gases and recommended gas concentrations>

The calibration gases and recommended gas concentrations are as follows. (Domestic standard)

Model	Calibration gas	Recommended value
OX-04G, OX-04	N ₂	99.9 % or more
CO-04	CO (N ₂ -based)	80 ppm
HS-04	H ₂ S (N ₂ -based)	16 ppm
CO-04 (C-)	CO (N ₂ -based)	80 ppm
	H ₂ (air-based)*	500 ppm

*H₂ (air-based) must be calibrated at ambient temperatures ranging from 10 °C to 30 °C.

Model	Calibration gas	Recommended value
CX-04	CO (N ₂ -based)	80 ppm
	N ₂	99.9 % or more
SC-04 (SO ₂)	SO ₂ (N ₂ -based)	8 ppm

<Connecting the equipment>

Before performing calibration, attach the calibration adapter, connect as shown below, then adjust the flow of the calibration gas to 250 ±10 mL/min.

Connect the gas sampling bag when the gas concentration display is blinking ([A-CAL] and [APPLY] alternate on the display) during AUTO calibration.

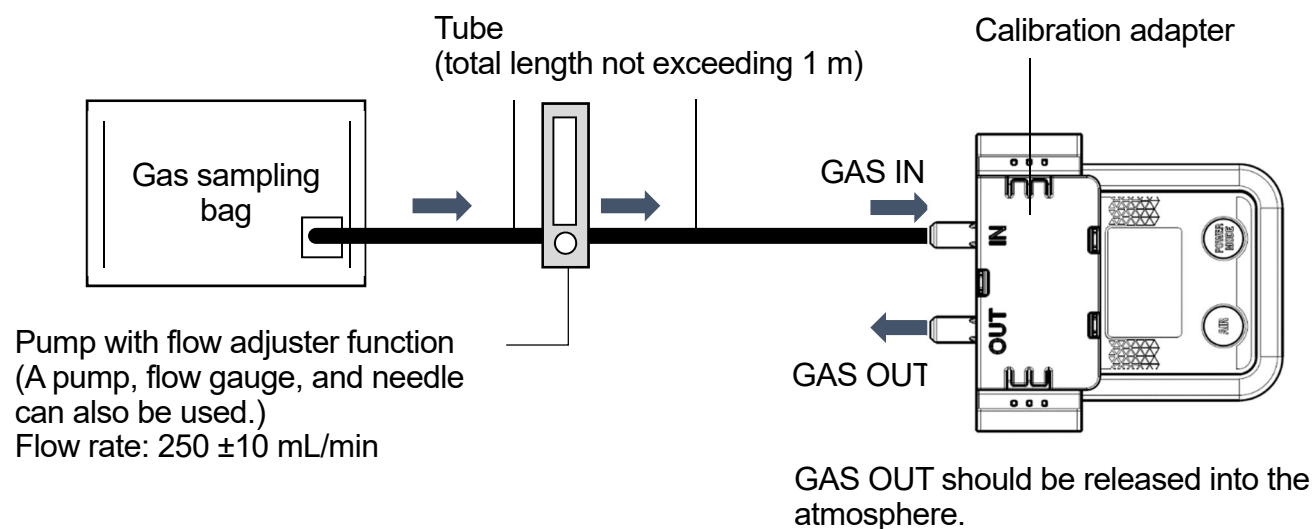

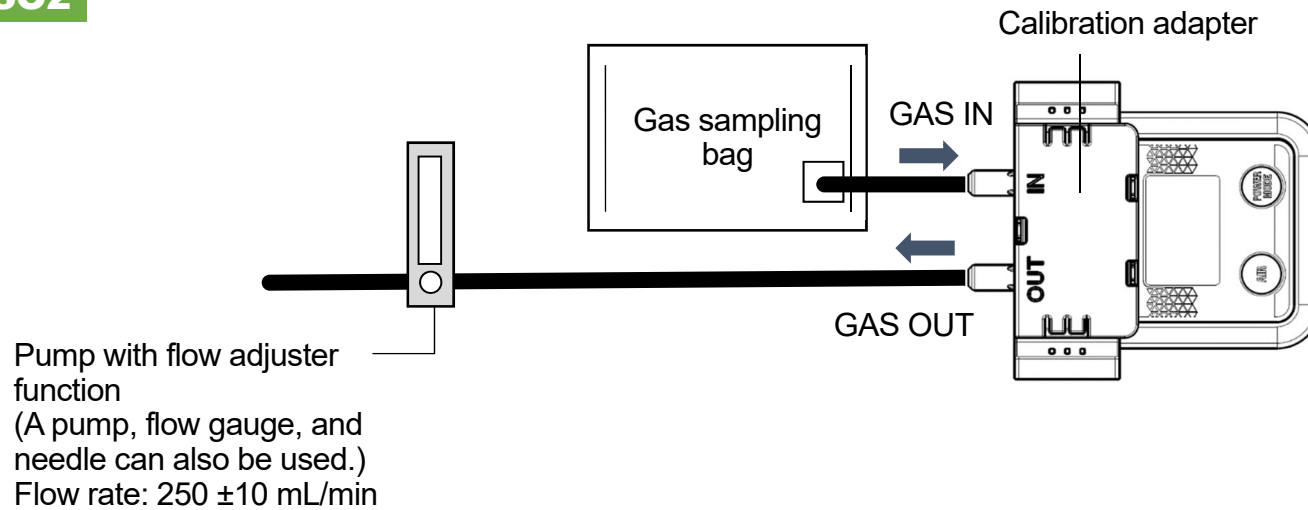
S02**WARNING****Gas sampling bag**

- Use different gas sampling bags for each gas type and concentration to ensure accurate calibration.

Calibration location

- Do not calibrate in confined spaces.
- Do not calibrate in locations where gases such as silicone and spray can gases are used.
- Calibrate indoors at normal temperatures free of significant temperature fluctuations (within ±5 °C).

**WARNING OX G****Handling the calibration gas**

- The calibration gas is nitrogen. Inhaling the gas may lead to loss of health or even death. When using calibration gas, discharge outside, perform calibration in a well-ventilated area, or use local ventilation equipment.
- The nitrogen used for calibration must be used by itself or as a gas mixture of nitrogen and oxygen. Calibration can be performed with gas mixtures that include other components. However, doing so will result in poor sensitivity and inaccurate concentration readings.

Handle the calibration gases and the equipment used for calibration with due care.

- Calibration gases include hazardous gases (e.g., nitrogen gas). Handle with due care.
-

**WARNING OX****Handling the calibration gas**

- The calibration gas is nitrogen. Inhaling the gas may lead to loss of health or even death. When using calibration gas, discharge outside, perform calibration in a well-ventilated area, or use local ventilation equipment.
- The nitrogen used for calibration must be used by itself or as a gas mixture of nitrogen and oxygen. Calibration can be performed with gas mixtures that include other components. However, doing so will result in poor sensitivity and inaccurate concentration readings.
- Do not expose the product to sudden pressure fluctuations. Oxygen readings will fluctuate briefly, preventing accurate calibration.

Handle the calibration gases and the equipment used for calibration with due care.

- Calibration gases include hazardous gases (e.g., nitrogen gas). Handle with due care.
 - Do not apply a load on the GAS OUT end.
-

**WARNING CO****Handling the calibration gas**

- The calibration gas (carbon monoxide) is toxic. Inhaling the gas may lead to loss of health or even death. When using calibration gas, discharge outside, perform calibration in a well-ventilated area, or use local ventilation equipment.
- The calibration gas used should be a standard gas, which is carbon monoxide diluted with nitrogen or air. Calibration can be performed with a gas mixture that includes other components. However, such calibrations will result in poor sensitivity and inaccurate concentration readings.

Handle the calibration gases and the equipment used for calibration with due care.

- Calibration gases include hazardous gases (e.g., toxic gases, nitrogen gas). Handle with due care.

**WARNING HS****Handling the calibration gas**

- The calibration gas (hydrogen sulfide) is toxic. Inhaling the gas may lead to loss of health or even death. When using calibration gas, discharge outside, perform calibration in a well-ventilated area, or use local ventilation equipment.
- The calibration gas used should be a standard gas consisting of hydrogen sulfide diluted with nitrogen or air. Calibration can be performed with gas mixtures that include other components. However, doing so will result in poor sensitivity and inaccurate concentration readings.

Handle the calibration gases and the equipment used for calibration with due care.

- Calibration gases include hazardous gases (e.g., toxic gases, nitrogen gas). Handle with due care.

**WARNING****C-****Handling the calibration gas**

- The calibration gas (carbon monoxide) is toxic. Inhaling the gas may lead to loss of health or even death. When using calibration gas, discharge outside, perform calibration in a well-ventilated area, or use local ventilation equipment.
- The calibration gases used should be a standard gas consisting of carbon monoxide diluted with nitrogen or air and a standard gas consisting of hydrogen diluted with air. Calibration can be performed with gas mixtures that include other components. However, doing so will result in poor sensitivity and inaccurate concentration readings.
- The carbon monoxide sensor with hydrogen compensation must be calibrated separately for carbon monoxide and hydrogen.
- If hydrogen sensitivity calibration is not performed, carbon monoxide readings may be inaccurate due to hydrogen interference.
- Due to the hydrogen compensation mechanism, carbon monoxide readings may increase temporarily if hydrogen gas concentrations increase rapidly in the atmosphere being measured.

Handle the calibration gases and the equipment used for calibration with due care.

- Calibration gases include hazardous gases (e.g., combustible gases, toxic gases, nitrogen gas). Handle with due care.

**WARNING****CX****Handling the calibration gas**

- The calibration gases are nitrogen and toxic carbon monoxide. Inhaling the gas may lead to loss of health or even death.

When using calibration gas, discharge outside, perform calibration in a well-ventilated area, or use local ventilation equipment.

- Using a gas mixture of carbon monoxide and nitrogen allows calibration for both carbon monoxide and oxygen.
- Do not expose the product to sudden pressure fluctuations. Oxygen readings will fluctuate briefly, preventing accurate calibration.

Handle the calibration gases and the equipment used for calibration with due care.

- Calibration gases include hazardous gases (e.g., combustible gases, toxic gases, nitrogen gas). Handle with due care.
- Do not apply a load on the GAS OUT end.

**WARNING** SO₂**Handling the calibration gas**

- The calibration gas (sulfur dioxide) is toxic. Inhaling the gas may lead to loss of health or even death. When using calibration gas, discharge outside, perform calibration in a well-ventilated area, or use local ventilation equipment.
- The calibration gas used should be a standard gas consisting of sulfur dioxide diluted with nitrogen or air. Calibration can be performed with gas mixtures that include other components. However, doing so will result in poor sensitivity and inaccurate concentration readings.

Handle the calibration gases and the equipment used for calibration with due care.

- Calibration gases include hazardous gases (e.g., toxic gases, nitrogen gas). Handle with due care.
-

7-2-2. Displaying the calibration (GAS CAL) screen

Calibration is performed with the calibration function (GAS CAL) in user mode.
The following items can be performed or set with the calibration function (GAS CAL):

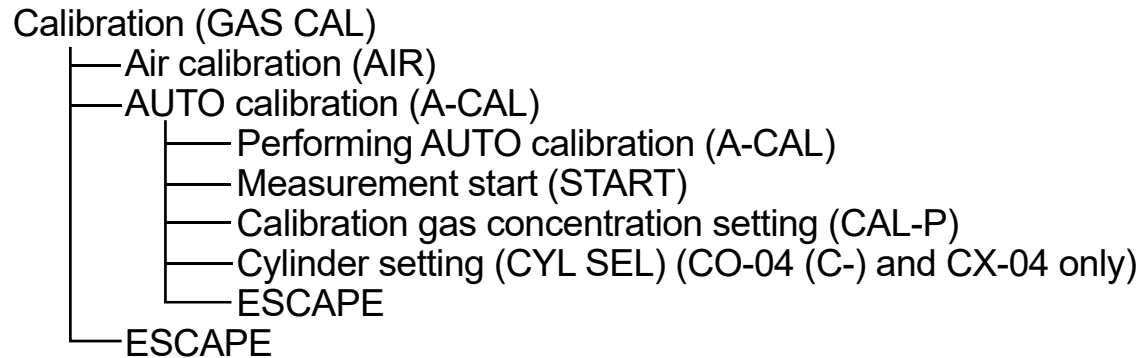

NOTE

- ▶ With the power turned off, hold down the AIR button and the POWER/MODE button at the same time (for about three seconds) to enter user mode. (Refer to '6-1. User mode setting procedure'.)
- ▶ Following successful calibration, the product will automatically return to measurement mode. However, if multiple cylinders are set (CO-04 (C-) and CX-04 only), the product will not automatically return to measurement mode.
- ▶ Do the following to return to measurement mode from the calibration (GAS CAL) screen:
 - ① Press the AIR button several times to select [A-CAL], then press the POWER/MODE button.
 - ② Press the AIR button several times to select [START], then press the POWER/MODE button.User mode ends. The product will return to measurement mode after performing the same operation as when the power is turned on.
- ▶ To end calibration (GAS CAL), press the AIR button several times to select [ESCAPE], then press the POWER/MODE button. The display returns to the user mode menu.
- ▶ To end AUTO calibration (A-CAL), press the AIR button several times to select [ESCAPE], then press the POWER/MODE button. The display returns to the calibration (GAS CAL) menu.

7-2-3. Performing air calibration



WARNING

- When air calibration is performed in the atmosphere, check the atmosphere for freshness before starting. The presence of interference gases will prevent proper air calibration. The presence of interference gases is also extremely dangerous because the product may not detect actual gas leaks correctly.
-



CAUTION

OX**CO****HS****C-****CX****SO₂**

- Perform air calibration in an environment that meets all of the following conditions:
 - Pressures, temperatures, and humidity levels are similar to pressures, temperatures, and humidity levels in the actual usage environment.
 - In fresh air
 - Wait for the readout to stabilize before performing air calibration.
 - If the temperature difference between the storage location and usage location is 15 °C or greater, turn on the power and allow the product to adjust to ambient conditions similar to those at the usage location for about 10 minutes. After this, air calibrate in fresh air before use.
-

**CAUTION OX G**

- Perform air calibration in an environment that meets all of the following conditions:
 - Pressures, temperatures, and humidity levels are similar to pressures, temperatures, and humidity levels in the actual usage environment.
 - In fresh air
- Wait for the readout to stabilize before performing air calibration.
- If the temperature difference between the storage location and usage location is 15 °C or greater, turn on the power and allow the product to adjust to ambient conditions similar to those at the usage location for about 30 minutes. After this, air calibrate in fresh air before use.

1 Press the AIR button several times in user mode to select [GAS CAL], then press the POWER/MODE button.

2 Select [AIR], then press the POWER/MODE button.

3 Hold down the AIR button.

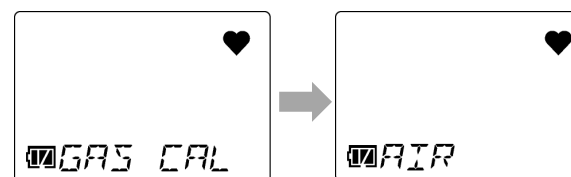

- 4 Release the AIR button once the LCD display changes from [Air HOLD] to [AdJ RELEASE]. When air calibration succeeds, [PASS] appears.

After air calibration, the current gas concentration appears, and the display returns to the [AIR] screen.



NOTE

- ▶ If air calibration fails, [FAIL AIR] will appear. Air calibration will not be performed. Press the POWER/MODE button to reset the fault alarm (calibration abnormality). Resetting the alarm displays the value before air calibration.

7-2-4. Performing AUTO calibration

Introduce the calibration gas and perform calibration at the gas concentration set in the calibration gas concentration setting (CAL-P).

**CAUTION**

- Air calibration must always be performed before AUTO calibration.

<Performing AUTO calibration (A-CAL)>
OX G
OX

- 1 Press the AIR button several times in user mode to select [GAS CAL], then press the POWER/MODE button.
- 2 Press the AIR button several times to select [A-CAL], then press the POWER/MODE button.
- 3 Confirm the name of the gas to calibrate, then press the POWER/MODE button.
- 4 Introduce the calibration gas, wait 60 seconds, then press the POWER/MODE button.

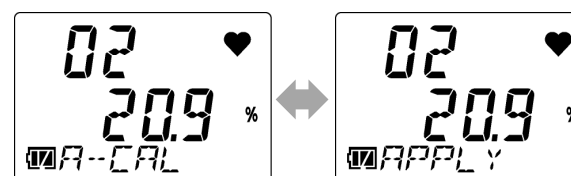
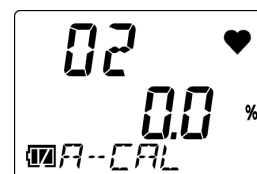
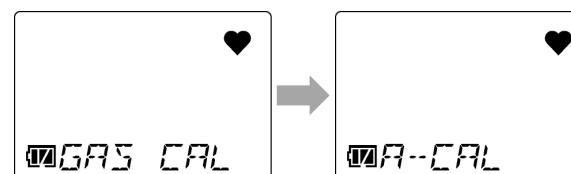

AUTO calibration starts.



5 Check the AUTO calibration result.

If AUTO calibration is successful
[PASS] appears, followed by the gas concentration
after AUTO calibration.
After this, the product returns automatically to
measurement mode.

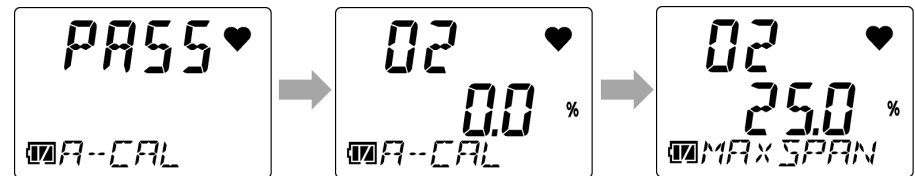

If AUTO calibration fails
[FAIL] appears.



<Performing AUTO calibration (A-CAL)> **CO** **HS** **SO2** (Display example: CO-04)

- 1 Press the AIR button several times in user mode to select [GAS CAL], then press the POWER/MODE button.
- 2 Press the AIR button several times to select [A-CAL], then press the POWER/MODE button.
- 3 Confirm the name of the gas to calibrate, then press the POWER/MODE button.

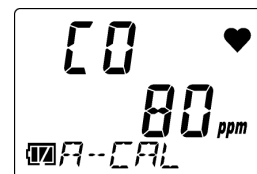
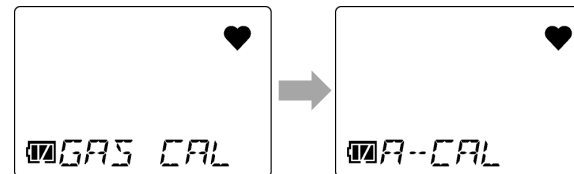

- 4 Introduce the calibration gas, wait 60 seconds, then press the POWER/MODE button.

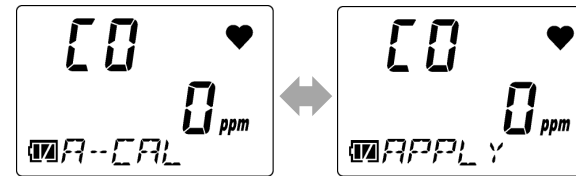

AUTO calibration starts.

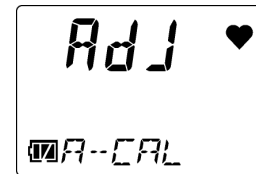

- 5 Check the AUTO calibration result.

If AUTO calibration is successful [PASS] appears, followed by the gas concentration after AUTO calibration.

After this, the product returns automatically to measurement mode.

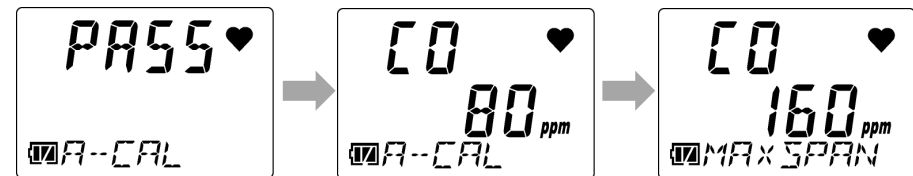

[FAIL] appears if AUTO calibration fails.



<Performing AUTO calibration (A-CAL)> **C-** **CX** (Display example: CX-04)

- 1 Press the AIR button several times in user mode to select [GAS CAL], then press the POWER/MODE button.
- 2 Press the AIR button several times to select [A-CAL], then press the POWER/MODE button.
- 3 Press the AIR button to select the cylinder to calibrate, then press the POWER/MODE button.
- 4 Introduce the calibration gas, wait 60 seconds, then press the POWER/MODE button.

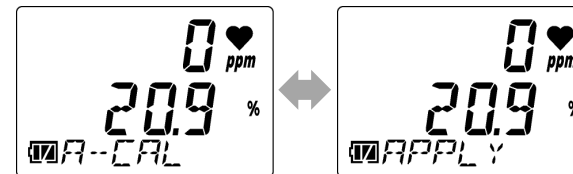
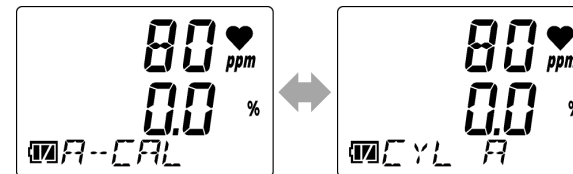
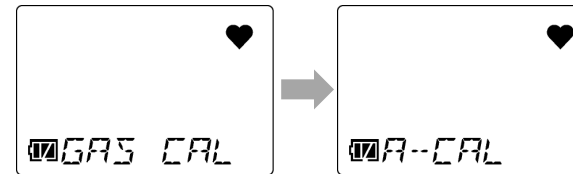

AUTO calibration starts.

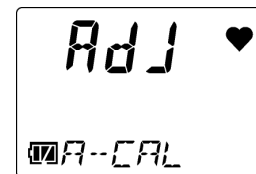

5 Check the AUTO calibration result.

If AUTO calibration is successful

[PASS] appears, followed by the gas concentration after AUTO calibration.

After this, the product returns automatically to measurement mode.

However, if multiple cylinders are set, the product will not automatically return to measurement mode.

If AUTO calibration fails

[FAIL] appears.

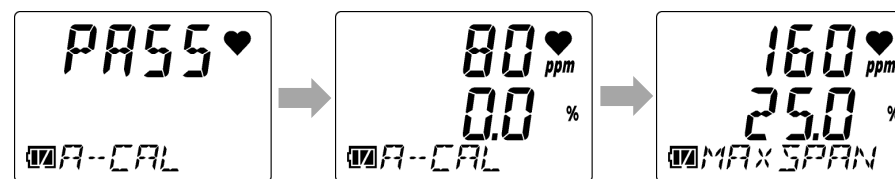

Upper row: [CO] AUTO calibration result
Middle row: [O2] AUTO calibration result

NOTE

- ▶ When the quick calibration function is enabled, the AUTO calibration menu display changes to [E-CAL]. Select [E-CAL], then press the POWER/MODE button. After the introduction of the calibration gas, AUTO calibration is performed by automatically counting down the calibration time set with the quick calibration time setting (E-CAL). (Refer to '6-11. Quick calibration time setting (E-CAL)'.)

<Calibration gas concentration setting (CAL-P)> **OX G** **OX** **CO** **HS** **SO2** (Display example: CO-04)

- 1 Press the AIR button several times in user mode to select [GAS CAL], then press the POWER/MODE button.
- 2 Press the AIR button several times to select [A-CAL], then press the POWER/MODE button.
- 3 Press the AIR button several times to select [CAL-P], then press the POWER/MODE button.
- 4 Confirm the name of the target gas, then press the POWER/MODE button.
- 5 Press the AIR button several times to set the calibration gas concentration, then press the POWER/MODE button.

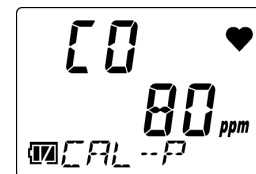
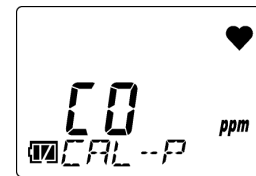
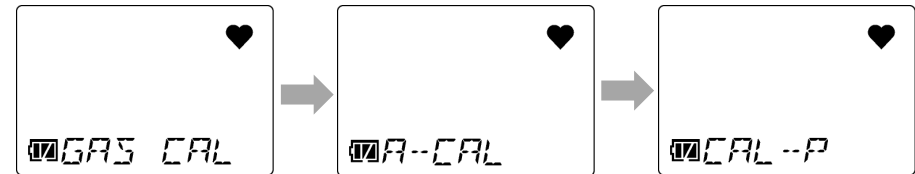

[END] appears once the settings are complete. The display returns to the [CAL-P] (target gas confirmation) screen.

<Calibration gas concentration setting (CAL-P)>



- 1 Press the AIR button several times in user mode to select [GAS CAL], then press the POWER/MODE button.
- 2 Press the AIR button several times to select [A-CAL], then press the POWER/MODE button.
- 3 Press the AIR button several times to select [CAL-P], then press the POWER/MODE button.
- 4 Press the AIR button several times to select the target gas, then press the POWER/MODE button.

CO-04 (C-): Select either [CO] or [H₂].

CX-04: Select either [CO] or [O₂].

- 5 Press the AIR button several times to set the calibration gas concentration, then press the POWER/MODE button.

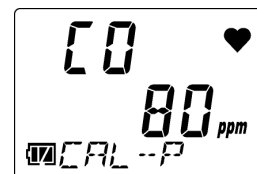
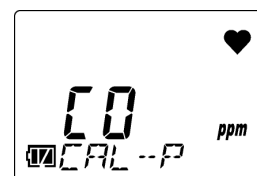
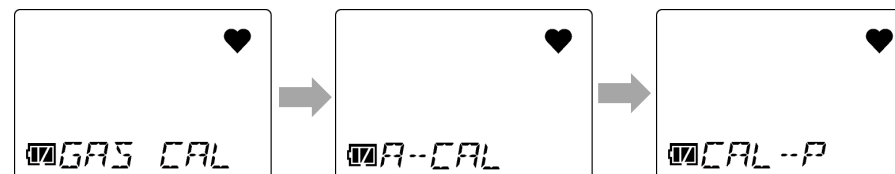

[END] appears once the settings are complete. The display returns to the [CAL-P] (target gas selection) screen.

<Cylinder setting (CYL SEL)> **C-** **CX**

Set gas groups (cylinders) for calibration. Five cylinders can be set as A to E.

The default settings are as follows:

CO-04 (C-): [CO]: A, [H2]: B

CX-04: [CO]: A, [O2]: A

NOTE

- ▶ Under most circumstances, there is no need to change the cylinder setting. Change the cylinder setting if [CO] (carbon monoxide) and [O2] (oxygen) are to be calibrated separately on the CX-04.

1 Press the AIR button several times in user mode to select [GAS CAL], then press the POWER/MODE button.

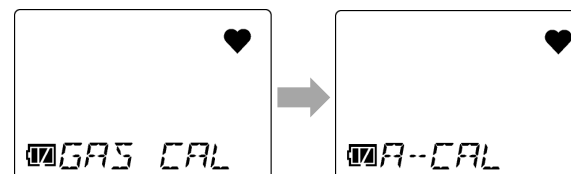

2 Press the AIR button several times to select [A-CAL], then press the POWER/MODE button.

3 Press the AIR button.

Pressing the AIR button displays the gas type and concentration for cylinders A to E in sequence.

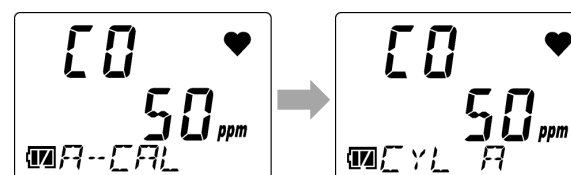

4 Press the AIR button several times to select [CYL SEL], then press the POWER/MODE button.

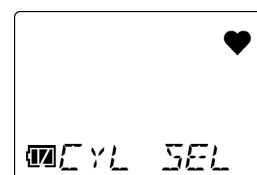

- 5 Press the AIR button several times to select the detection target gas, then press the POWER/MODE button.**

Pressing the AIR button cycles through the detection target gases.

CO-04 (C-): [CO] → [H2] → [ESCAPE]

CX-04: [CO] → [O2] → [ESCAPE]

Selecting [ESCAPE] and pressing the POWER/MODE button returns the display to the AUTO calibration (A-CAL) screen.

To cancel the cylinder setting, press the AIR button until [ESCAPE] appears.

- 6 Press the AIR button several times to select a cylinder, then press the POWER/MODE button.**
Select from [A] to [E].

[END] appears once the settings are complete. The display returns to the [CYL SEL] (target gas selection) screen.

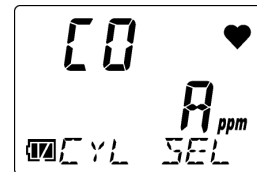
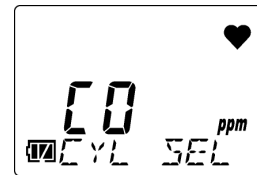

7-3. Performing bump tests

Bump tests are performed using the bump test function (BUMP) in user mode.

The bump test (function check) is a test for checking whether the readings are within the acceptable range by introducing a calibration gas.

As with calibration, prepare the equipment and calibration gases, then connect to this product. (Refer to '7-2-1. Preparation for calibration'.)

NOTE

- ▶ With the power turned off, hold down the AIR button and the POWER/MODE button at the same time (for about three seconds) to enter user mode. (Refer to '6-1. User mode setting procedure'.)
- ▶ Following a successful bump test, the product will automatically return to measurement mode. However, if multiple cylinders are set (CO-04 (C-) and CX-04 only), the product will not automatically return to measurement mode.
- ▶ To return to measurement mode from the bump test (BUMP) screen, press the AIR button several times to select [START], then press the POWER/MODE button. User mode ends. The product will return to measurement mode after performing the same operation as when the power is turned on.
- ▶ To end the bump test (BUMP), press the AIR button several times to select [ESCAPE], then press the POWER/MODE button. The display returns to the user mode menu.

OX G OX

- 1 Press the AIR button several times in user mode to select [BUMP], then press the POWER/MODE button.

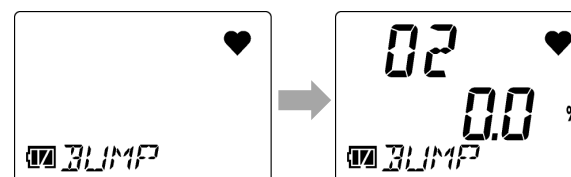

2 Introduce the calibration gas, then press the POWER/MODE button.

[APLY] and [BUMP] alternate on the display. The time until the bump test starts is displayed on the right side.

The bump test starts when the remaining time reaches [0].

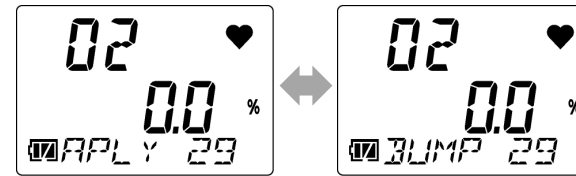

3 Check the bump test result.

If the bump test is successful [P] appears in the [BMP/CAL] screen. Press the AIR button to view the reading at the time of the bump test.

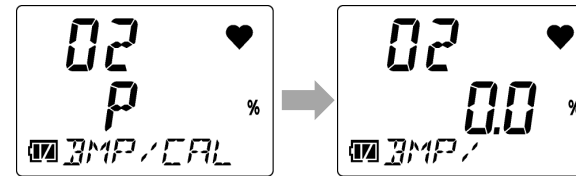

If the bump test fails [F] appears in the [BMP/CAL] screen (left side of middle row). Press the AIR button to view the reading at the time of the bump test.



After a bump test failure, calibration is performed if specified in the setting. Once calibration is complete, the calibration result is displayed on the [BMP/CAL] screen (right side of middle row), then each time the AIR button is pressed, the display shows the reading at the time of the bump test and the calibration reading.

Left side of middle row:
Bump test result
Right side of middle row:
Calibration result
(P: Passed/F: Failed)

(Displayed only if calibration was performed)

4 Press the POWER/MODE button.

[END] appears. If the bump test is successful, the product will automatically return to measurement mode.

CO **HS** **SO2** (Display example: CO-04)

1 Press the AIR button several times in user mode to select [BUMP], then press the POWER/MODE button.

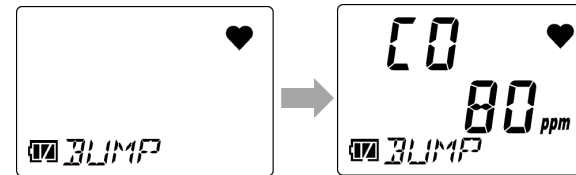

2 Introduce the calibration gas, then press the POWER/MODE button.
[APLY] and [BUMP] alternate on the display. The time until the bump test starts is displayed on the right side.
The bump test starts when the remaining time reaches [0].

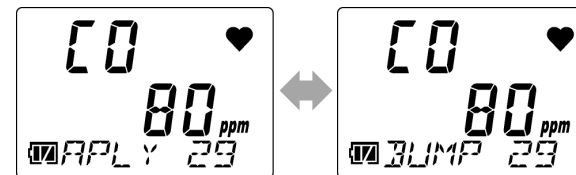

3 Check the bump test result.

If the bump test is successful [P] appears in the [BMP/CAL] screen. Press the AIR button to view the reading at the time of the bump test.

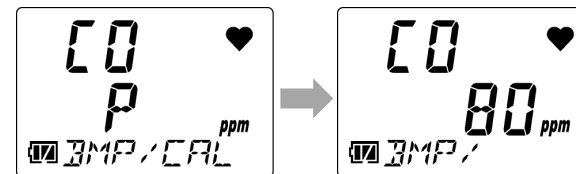

If the bump test fails

[F] appears in the [BMP/CAL] screen (left side of middle row). Press the AIR button to view the reading at the time of the bump test.

After a bump test failure, calibration is performed if specified in the setting. Once calibration is complete, the calibration result is displayed on the [BMP/CAL] screen (right side of middle row), then each time the AIR button is pressed, the display shows the reading at the time of the bump test and the calibration reading.

4 Press the POWER/MODE button.

[END] appears. If the bump test is successful, the product will automatically return to measurement mode.

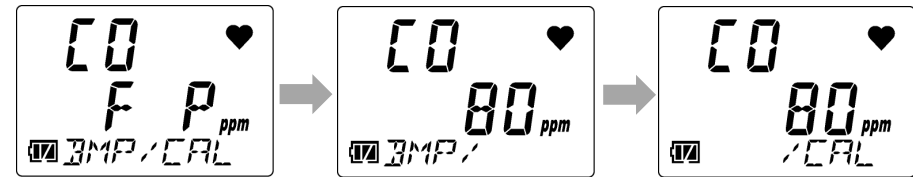

Left side of middle row:
Bump test result
Right side of middle row:
Calibration result
(P: Passed/F: Failed)

(Displayed only if
calibration was
performed)

C- **CX** (Display example: CX-04)

1 Press the AIR button several times in user mode to select [BUMP], then press the POWER/MODE button.

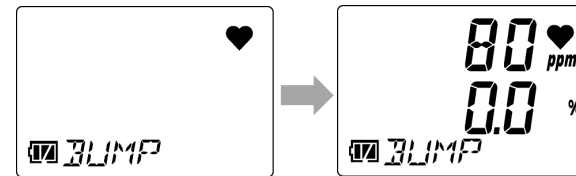

2 Press the AIR button several times to select the cylinder for the bump test, then press the POWER/MODE button.

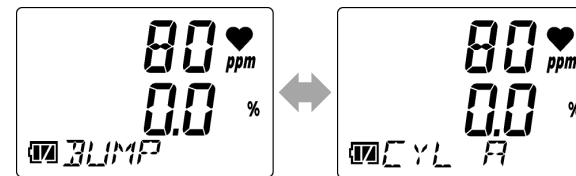

3 Introduce the calibration gas, then press the POWER/MODE button.
[APLY] and [BUMP] alternate on the display. The time until the bump test starts is displayed on the right side.
The bump test starts when the remaining time reaches [0].

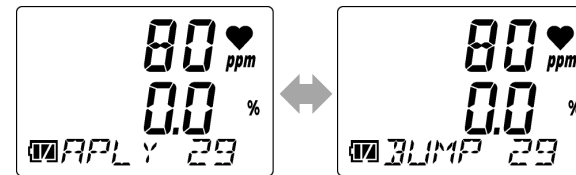

4 Check the bump test result.

If the bump test is successful [P] appears in the [BMP/CAL] screen. Press the AIR button to view the reading at the time of the bump test.

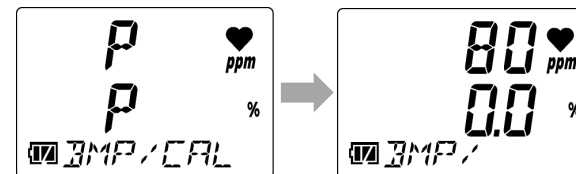

Upper row: [CO] bump test result
Middle row: [O2] bump test result

If the bump test fails

[F] appears in the [BMP/CAL] screen (left side).

Press the AIR button to view the reading at the time of the bump test.

After a bump test failure, calibration is performed if specified in the setting. Once calibration is complete, the calibration result is displayed on the [BMP/CAL] screen (right side), then each time the AIR button is pressed, the display shows the reading at the time of the bump test and the calibration reading.

5 Press the POWER/MODE button.

[END] appears. If the bump test is successful, the product will automatically return to measurement mode.

However, if multiple cylinders are set, the product will not automatically return to measurement mode.

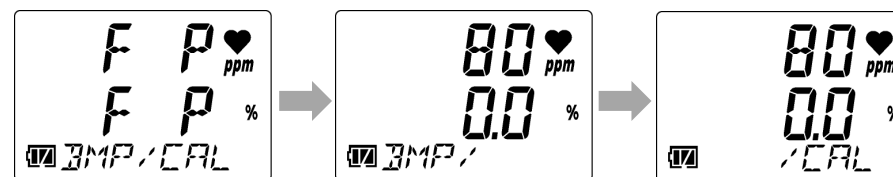

Left side of upper row:

[CO] bump test result

Right side of upper row:

[CO] calibration result

Left side of middle row:

[O2] bump test result

Right side of middle row:

[O2] calibration result)

(P: Passed/F: Failed)

(Displayed only if
calibration was
performed)

NOTE

- ▶ The bump test expiration and the various conditions for bump testing are set in the bump test expiration setting (BUMP.SET) in user mode. (Refer to '6-4. Bump test expiration setting (BUMP.SET)').
- ▶ After a bump test failure, set the bump test calibration ON/OFF (A-CAL) setting to ON to perform calibration after the bump test. (Refer to '6-4-1. Bump test setting (SETTING)').

7-4. Performing alarm tests

By pressing the AIR button and the POWER/MODE button at the same time while displaying any of the alarm setpoints in the alarm setpoint display of display mode, you can test the relevant alarm.

1 Press the POWER/MODE button in measurement mode.

The buzzer blips once, and the product switches to display mode.

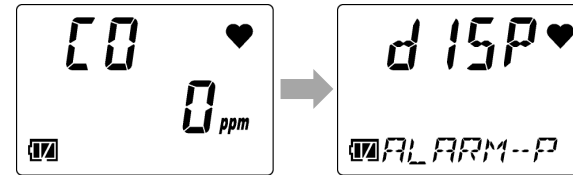

2 Press the POWER/MODE button several times to select the alarm setpoint display [dISP].

3 Press the AIR button several times to select the alarm setpoint for the alarm test.

Pressing the AIR button cycles through the alarm setpoints.

For the alarm setpoints displayed, see '5-6-2. Items displayed in display mode'.



4 Press the AIR button and the POWER/MODE button at the same time.

This activates the selected alarm setpoint alarm.

Press the POWER/MODE button to reset the alarm.

NOTE

- ▶ For information on the alarm patterns at the different alarm setpoints, see '4-2. Gas alarm activation'.
 - ▶ The gas concentration on the LCD display will not blink in alarm tests.
 - ▶ To end display mode, press the POWER/MODE button, select the buzzer volume setting screen, then press the POWER/MODE button. When the display mode item display setting (DISP.SET) is OFF, the buzzer volume setting screen is not displayed. Press the POWER/MODE button in the alarm setpoint display (ALARM-P) screen.
-

7-5. Cleaning instructions

Clean the product if it becomes excessively dirty.

Be sure to turn off the power before cleaning. Wipe clean using a cloth or rag soaked in water and firmly wrung out.

Do not clean using water, organic solvents, or commercially available cleaners for cleaning, as these may cause the product to malfunction.



CAUTION

- When wiping the product clean, do not splash water on it or use organic solvents like alcohol and benzene or commercially available cleaners.
These may discolor or damage the surface of the product, or cause the sensor to malfunction.

NOTE

- ▶ Water may remain in the buzzer sound opening or grooves if the product gets wet. Remove any moisture as follows:
 - ① Wipe off any moisture on the product using a dry towel or cloth.
 - ② Hold the product firmly and shake about 10 times with the buzzer sound opening facing downward.
 - ③ Use a towel or cloth to wipe up all moisture drained from the interior.
 - ④ Place the product on a dry towel or cloth and allow to stand at room temperature.

7-6. Parts replacement

For information on parts replacement, please contact Riken Keiki. A functional check by a qualified service engineer is also required after parts replacement.

For more information, contact Riken Keiki.

7-6-1. Periodic replacement parts

Listed below are the product's consumable parts. Replace the consumable parts based on the recommended replacement intervals.

<Recommended replacement parts list>

Name	Recommended check interval	Recommended replacement interval	Quantity (piece/unit)	Remarks
O₂ sensor (OS-BM2 C)	6 months	1 year	1	Sensor for OX-04G
O₂ sensor (ESR-X13P)	6 months	3 years	1	Sensor for OX-04
H₂S sensor (ESR-A13i)	6 months	3 years	1	Sensor for HS-04
CO sensor (ESR-A13P)	6 months	3 years	1	Sensor for CO-04
CO sensor (ESR-A1CP)	6 months	3 years	1	Sensor for CO-04 (C-)
CO/O₂ sensor (ESR-X1DP)	6 months	3 years	1	Sensor for CX-04
SO₂ sensor (ESR-A13D)	6 months	3 years	1	Sensor for SC-04 (SO ₂)
Dust filter	Before and after use	6 months or when contaminated	1	
Humidity control filter (CF-A13i-1)	3 months	6 months	1	Filter for HS-04

Name	Recommended check interval	Recommended replacement interval	Quantity (piece/unit)	Remarks
Interference gas removal filter (CF-1821)	3 months	6 months	1	Filter for CO-04/CO-04 (C-)
Interference gas removal filter (CF-6280)	3 months	6 months	1	Filter for CX-04
H₂S removal filter (CF-A13D-1)	3 months	6 months	1	Filter for SC-04 (SO ₂)
Rubber seal for switch	-	3 to 6 years	1	
Rubber seal for upper and lower cases	-	3 to 6 years	1	
Rubber seal for battery cover	-	3 to 6 years	1	
Rubber seal for sensor	-	3 to 6 years	1	
AAA alkaline batteries	-	-	2	Dry cell specifications
AAA Ni-MH batteries	-	-	2	Rechargeable battery specifications

*A functional check must be performed by a qualified service engineer after parts replacement to ensure safety and the stable operation of the product. Contact Riken Keiki to request a functional check.

NOTE

- ▶ The above replacement intervals are guidelines. Replacement intervals may vary depending on actual operating conditions. In addition, these intervals do not constitute warranty periods. Replacement intervals may vary depending on the results of regular maintenance.

7-6-2. Filter replacement

OX G OX

The dust filter is a consumable. Check the extent of the contamination and replace periodically at appropriate intervals.

1 Turn off the power.

Hold down the POWER/MODE button for at least three seconds to turn off the power.

2 Remove the rubber protection cover.

3 Position with the display facing down, then loosen the four screws with a Phillips head screwdriver.

4 Position with the display facing up. Remove the upper case.

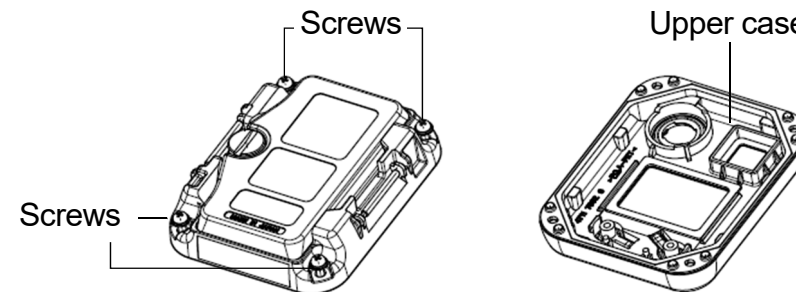

5 Remove the rubber seal and dust filter from the upper case.

6 Replace the dust filter.

7 Attach the rubber seal.

Refer to the diagram at right and note the orientation of the rubber seal when fitting.

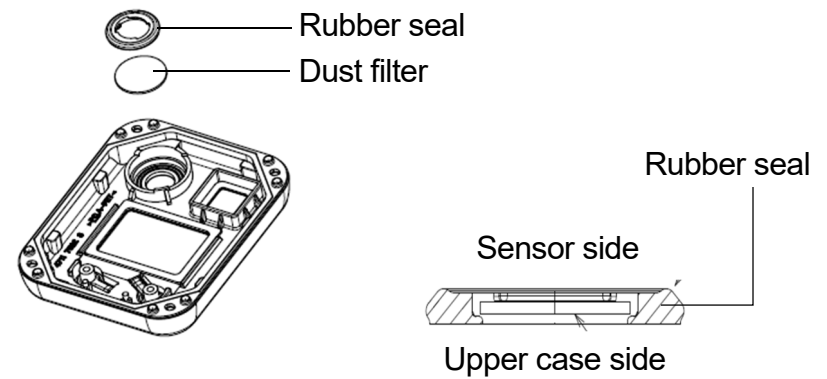

8 Return the upper case to its original position. Tighten the four screws with the Phillips head screwdriver.

Tighten the screws to a torque of 15 to 16 N·cm with the Phillips head screwdriver.

9 Attach the rubber protection cover.



CAUTION

- Replace filters approximately every six months.
- Handle filters carefully. Do not use this product with damaged filters.



The dust filter and filter are consumables. Check the extent of the contamination and replace periodically at appropriate intervals.

The filter types are as follows:

- CO-04, CO-04 (C-): Interference gas removal filter CF-1821
- HS-04: Humidity control filter CF-A13i-1
- CX-04: Interference gas removal filter CF-6280
- SC-04 (SO₂): H₂S removal filter CF-A13D-1

1 Turn off the power.

Hold down the POWER/MODE button for at least three seconds to turn off the power.

2 Remove the rubber protection cover.

3 Position with the display facing down, then loosen the four screws with a Phillips head screwdriver.

4 Position with the display facing up. Remove the upper case.

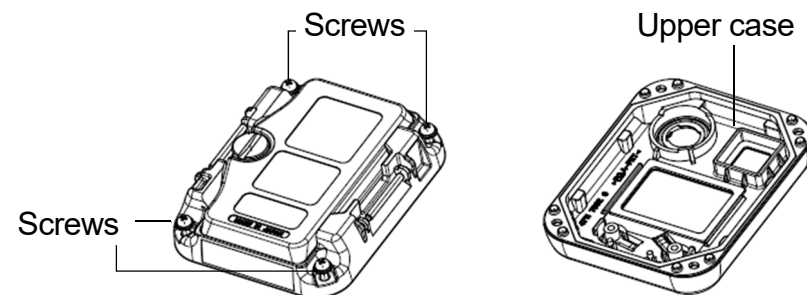

5 Remove the filter, rubber seal, and dust filter from the upper case.

6 Replace the dust filter.

7 Attach the rubber seal.

Note the orientation of the rubber seal when fitting. Refer to the diagram at right and note the orientation of the rubber seal when fitting.

8 Replace the filter.

9 Return the upper case to its original position. Tighten the four screws with the Phillips head screwdriver.

Tighten the screws to a torque of 15 to 16 N·cm with the Phillips head screwdriver.

10 Attach the rubber protection cover.

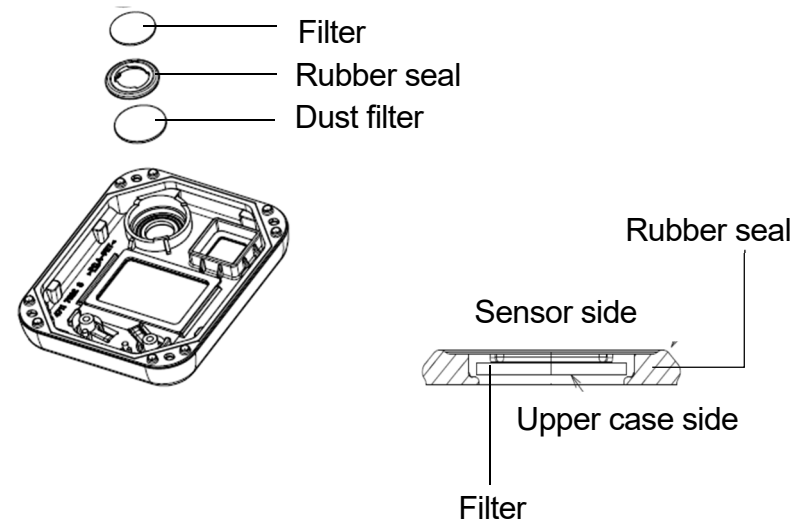

CAUTION

- Chemicals have been applied to the interference gas removal filter CF-1821, humidity control filter CF-A13i-1, interference gas removal filter CF-6280, and H₂S removal filter CF-A13D-1. When replacing the filters, hold with tweezers. Work carefully to avoid damaging the filters or touching with bare hands. Wash your hands immediately if they come into contact with the chemical.
- Replace filters approximately every six months.
- Handle filters carefully. Do not use this product with damaged filters.

NOTE

- ▶ The interval for replacing the filters (six months) is a guideline value. Actual intervals may vary depending on operating conditions. These intervals do not constitute warranty periods. The replacement timing may vary depending on the results of daily and regular maintenance.
- ▶ Be sure to turn off the power for the product before replacing the filters.
- ▶ The rubber seals also contain filters. Handle with care, as they are easily damaged.
- ▶ When assembling the upper case, make sure no foreign matter is trapped in the rubber seal around the upper case.

7-6-3. Sensor replacement

The sensor needs to be replaced if you encounter symptoms like failure to restore readings after air calibration or fluctuating readings when performing calibration.

Contact Riken Keiki for replacement.

OX G**1 Turn off the power.**

Hold down the POWER/MODE button for at least three seconds to turn off the power.

2 Remove the rubber protection cover.

- 3** Position with the display facing down, then loosen the four screws with a Phillips head screwdriver.
- 4** Position with the display facing up. Remove the upper case.
- 5** Replace the sensor.
Insert the sensor fully.
- 6** Return the upper case to its original position.
Tighten the four screws with the Phillips head screwdriver.
Tighten the screws to a torque of 15 to 16 N·cm with the Phillips head screwdriver.
- 7** Attach the rubber protection cover.

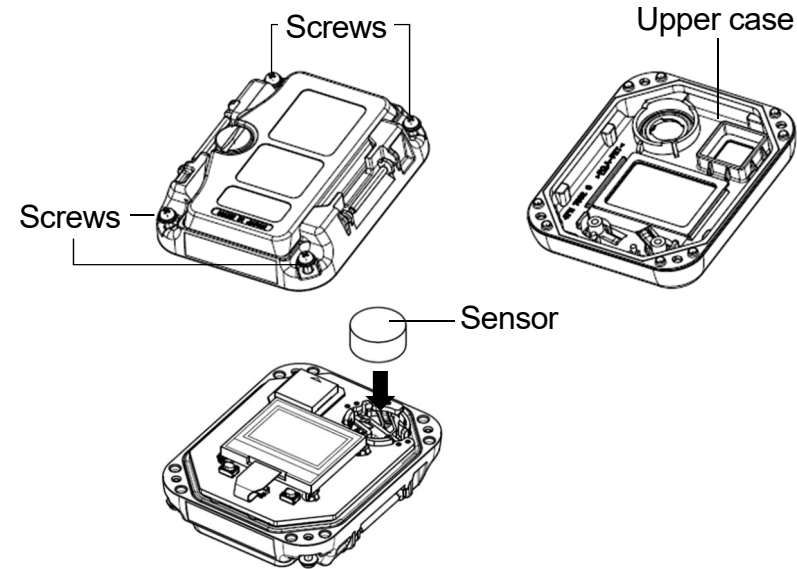

OX **CO** **HS** **C-** **CX** **SO2**

1 Turn off the power.

Hold down the POWER/MODE button for at least three seconds to turn off the power.

2 Remove the rubber protection cover.

3 Position with the display facing down, then loosen the four screws with a Phillips head screwdriver.

4 Position with the display facing up. Remove the upper case.

5 Replace the sensor.

Match the Δ marks on the sensor to the matching locations on the sensor case, then insert the sensor fully.

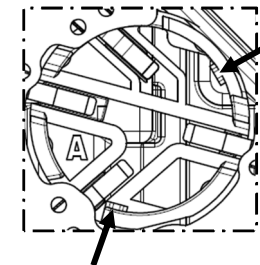
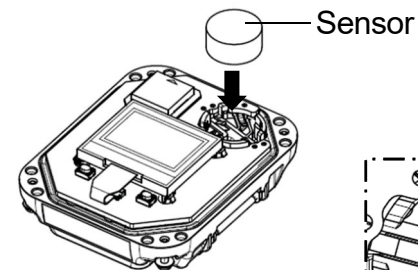
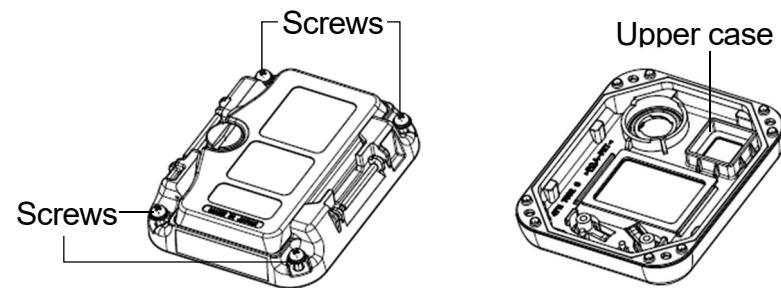

Locations to match when fitting the sensor
(CO-04/HS-04/SC-04 (SO2))

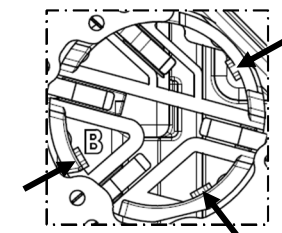

Locations to match when fitting the sensor
(OX-04, CX-04)

- 6 Return the upper case to its original position.
Tighten the four screws with the Phillips head
screwdriver.**

Tighten the screws to a torque of 15 to 16 N·cm with the Phillips head screwdriver.

- 7 Attach the rubber protection cover.**

NOTE

- ▶ The rubber seals also contain filters. Handle with care, as they are easily damaged.
 - ▶ When assembling the upper case, make sure no foreign matter is trapped in the rubber seal around the upper case.
-

8

Storage and Disposal**8-1. Procedures for storage or when not in use for extended periods**

The product must be stored in the following environment:

- In a dark place at normal temperatures and humidity and away from direct sunlight
- In a place free of gases, solvents, and vapor

Store the product in its shipping carton, if retained and available. If the shipping carton is not available, store away from dust and dirt.

**CAUTION**

- If the product is not to be used for extended periods, store with the battery removed. Battery leaks may result in fire or injury.

<Procedure for reuse>

Perform calibration if the product is used again after a period in storage. (Refer to '7-2. Performing calibration'.)

8-2. Product disposal

Dispose of the product as industrial waste (incombustible) in accordance with local regulations.



WARNING

- Dispose of batteries in accordance with procedures specified by local authorities.

<Disposal in EU member states>

When disposing of the product in an EU member state, dispose of the batteries separately.

The batteries must be removed and disposed of appropriately in accordance with waste sorting and collection or recycling systems stipulated by the regulations of EU member states.

NOTE

Crossed-out recycle dustbin mark

The pictogram at right indicates that batteries must be separated from ordinary waste and disposed of appropriately.

This is affixed to products containing batteries to which EU Battery Directive 2006/66/EC applies.

Such batteries must be disposed of appropriately.



9

Troubleshooting

9-1. Product abnormalities

Symptom	Cause	Corrective action
The power cannot be turned on.	The batteries are depleted.	Turn off the power and replace with new batteries in a safe place. (Refer to '3-3. Inserting the batteries'.)
	The batteries were inserted with polarity reversed.	Reinsert the batteries correctly. (Refer to '3-3. Inserting the batteries'.)
	The POWER/MODE button was pressed too briefly or for too long.	To turn the power on, hold down the POWER/MODE button for at least three seconds until the buzzer blips once. (Refer to '5-3. Turning on the power'.)
	The battery cover is not closed completely.	Close the battery cover completely.
System abnormality: [FAIL SYSTEM] appears.	A circuit abnormality occurred in the main unit.	Contact Riken Keiki for repair.
Sensor abnormality: [FAIL SENSOR] appears.	The sensor sensitivity has degraded.	Contact Riken Keiki to request sensor replacement. (Refer to '7-6-2. Sensor replacement'.)

Symptom	Cause	Corrective action
Low battery voltage alarm: [FAIL BATTERY] appears.	Battery levels are low.	Turn off the power and replace with new batteries in a safe place. (Refer to '3-3. Inserting the batteries'.)
Air calibration is not possible. [FAIL AIR] appears.	Fresh air is not being supplied to the product.	Supply fresh air around the product.
	The sensor sensitivity has degraded.	Contact Riken Keiki to request sensor replacement. (Refer to '7-6-2. Sensor replacement'.)
Clock abnormality: [FAIL CLOCK] appears.	Internal clock abnormality	Set the date and time. (Refer to '6-12. Date and time setting (DATE)'). If this occurs frequently, the internal clock may be faulty. Contact Riken Keiki to request internal clock replacement.
The alarm does not stop even after gas concentrations fall below the alarm setpoint.	You did not press the POWER/MODE button.	For OX-04G, OX-04, HS-04, SC-04 (SO₂) The product alarms are self-latching. After the alarm occurs, press the POWER/MODE button. For CO-04, CO-04 (C-), CX-04 If the gas alarm pattern is self-latching, press the POWER/MODE button after the alarm occurs.

NOTE

- ▶ This troubleshooting section does not address all problems that may occur with the product. Brief explanations of causes and corrective actions have been provided to help correct common problems that may occur frequently. If problems persist even after taking the corrective actions suggested here or if you encounter symptoms not listed here, contact Riken Keiki.

10

Product Specifications

10-1. Common specifications

Concentration display	LCD digital display (segments + icons)
Gas alarm indications	Flashing lamp, intermittent buzzer sounding, gas concentration display blinking, vibration
Fault alarm/ self diagnosis	Sensor abnormality, low battery voltage, faulty calibration, clock abnormality, system abnormality
Fault alarm indications	Flashing lamp, intermittent buzzer sounding, fault information display
Detection method	Diffusion type
Power source	Dry cell specifications: AAA alkaline battery × 2 / Rechargeable battery specifications: AAA Ni-MH battery (eneloop) × 2
Protection level	IP67 equivalent
Explosion-proof construction	Intrinsically safe explosion-proof construction

Explosion-proof class	<p><Dry cell specifications> Certificate of conformity for electrical equipment used in potentially explosive atmospheres: Ex ia IIC T4 Ga ATEX: II 1G Ex ia IIC T4 Ga IECEX: Ex ia IIC T4 Ga</p> <p><Rechargeable battery specifications> Certificate of conformity for electrical equipment used in potentially explosive atmospheres: Ex ia IIC T3 Ga ATEX: II 1G Ex ia IIC T3 Ga IECEX: Ex ia IIC T3 Ga</p>
Certifications	Certificate of conformity for electrical equipment used in potentially explosive atmospheres, ATEX, IECEX
External dimensions	Approx. 54 mm (W) × 67 mm (H) × 24 mm (D) (excluding projections)
Weight	Approx. 93 g (including batteries)
Functions	Data logger, vibration, STEL alarm, cumulative or TWA alarm (for CO models only, for domestic models only), quick calibration, PEAK value display, temperature display

10-2. Specifications by model

Model	OX-04G	OX-04	HS-04	CO-04	CO-04 (C-)	CX-04		SC-04 (SO2)	
Detection target gas	Oxygen	Oxygen	Hydrogen sulfide	Carbon monoxide	Carbon monoxide (reduced hydrogen interference)	Carbon monoxide	Oxygen	Sulfur dioxide	
Detection principle	Galvanic cell type	Electrochemical type							
Display name	O2	O2	H2S	CO	CO	CO	O2	SO2	
Sensor model	OS-BM2 C	ESR-X13P	ESR-A13i	ESR-A13P	ESR-A1CP	ESR-X1DP		ESR-A13D	
Display range (1 digit)	0.0-40.0% (0.1)		0.0-30.0ppm (0.1) 30.0-200.0ppm (1.0)	0-300ppm (1) 300-2000ppm (10)		0-300ppm (1) 300-2000ppm (10)	0.0-40.0% (0.1)	0.00-100.00ppm (0.05)	
Measurement range / Service range (Japan standard)	0.0-25.0% /25.0-40.0%		0.0-30.0ppm /30.0-200.0ppm	0-500ppm /500-2000ppm		0-500ppm /500-2000ppm	0.0-25.0% /25.0-40.0%	0.00-20.00ppm /20.00-100.00ppm	
Measurement range / Service range (Export models)	0.0-25.0% /25.0-40.0%		0.0-100.0ppm /100.0-200.0ppm	0-500ppm /500-2000ppm		0-500ppm /500-2000ppm	0.0-25.0% /25.0-40.0%	0.00-20.00ppm /20.00-100.00ppm	
Alarm setpoints (Domestic standard)	L 18.0 % LL 18.0 % H 25.0 % OVER 40.0 %		1st 1.0 ppm 2nd 10.0 ppm 3rd 10.0 ppm TWA 1.0 ppm STEL 5.0 ppm OVER 200.0 ppm		1st 50 ppm 2nd 150 ppm 3rd 150 ppm Integrated 150 ppm STEL 200 ppm OVER 2,000 ppm		1st 50 ppm 2nd 150 ppm 3rd 150 ppm Integrated 150 ppm STEL 200 ppm OVER 2,000 ppm	L 18.0 % LL 18.0 % H 25.0 % OVER 40.0 %	1st 2.00 ppm 2nd 5.00 ppm 3rd 5.00 ppm TWA 2.00 ppm STEL 5.00 ppm OVER 100.00 ppm

10. Product Specifications

10-2. Specifications by model

Alarm setpoints (Export models)	L 18.0 % LL 18.0 % H 25.0 % OVER 40.0 %	1st 5 ppm 2nd 30.0 ppm 3rd 100.0 ppm TWA 1.0 ppm STEL 5.0 ppm OVER 200.0 ppm	1st 25 ppm 2nd 50 ppm 3rd 1,200 ppm TWA 25 ppm STEL 200 ppm OVER 2,000 ppm	1st 25 ppm 2nd 50 ppm 3rd 1,200 ppm TWA 25 ppm STEL 200 ppm OVER 2,000 ppm	L 18.0 % LL 18.0 % H 25.0 % OVER 40.0 %	1st 2.00 ppm 2nd 5.00 ppm 3rd 100.00 ppm TWA 2.00 ppm STEL 5.00 ppm OVER 100.00 ppm	
Alarm permitted setting range	L/LL 0.0 to 20.0 % H 21.8 to 40.0 %	1.0 to 200.0 ppm	20 to 2,000 ppm	20 to 2,000 ppm	L/LL 0.0 to 20.0 % H 21.8 to 40.0 %	1.00 to 100.00 ppm	
Gas alarm pattern	Self-latching	Self-latching	Domestic models: Auto reset Export models: Self-latching	Domestic models: Auto reset Export models: Self-latching		Self-latching	
Operating temperature range	-20 °C to +50 °C (no sudden changes)	Temporary use environment for approx. 15 minutes: -40 °C to +60 °C (no sudden changes) Continuous use environment: -20 °C to +50 °C (no sudden changes)					
Operating humidity range	10 to 90 %RH (no condensation)	Temporary use environment for approx. 15 minutes: 0 to 95 %RH (no condensation) Continuous use environment: 10 to 90 %RH (no condensation)					
Operating pressure range	80 kPa to 120 kPa (80 kPa to 110 kPa for explosion-proof range)						
Certifications	JIS T 8201: 2010	-	JIS T 8205: 2018	-			
Continuous operating time (Alkaline batteries)	Approx. 9,000 hours	Approx. 3,000 hours	Approx. 9,000 hours	Approx. 9,000 hours	Approx. 6,200 hours	Approx. 4,600 hours	Approx. 3,000 hours
Continuous operating time (Ni-MH batteries)	Approx. 6,000 hours	Approx. 2,000 hours	Approx. 6,000 hours	Approx. 6,000 hours	Approx. 4,200 hours	Approx. 3,000 hours	Approx. 2,000 hours

*25 °C, no alarm, no lighting

11

Appendix

11-1. Data logger function

The product is equipped with a data logger function that records measurement results and events such as gas alarms, fault alarms, and calibration.

NOTE

- ▶ The data logger management program (sold separately) is required to check data recorded using the data logger function. Contact Riken Keiki for more information.
-

The data logger has the following five functions:

(1) Interval trend

Records changes in measured concentration from the time the power is turned on until it is turned off.

The average value, PEAK value, and PEAK value detection time are recorded for carbon monoxide, hydrogen sulfide, and sulfur dioxide. The average value, minimum value, minimum value detection time, maximum value, and maximum value detection time are recorded for oxygen.

Records/retains the most recent 3,600 data items.

If the number of items exceeds 3,600, new data will overwrite the oldest data.

If overwriting is disabled, recording will stop at 3,600 data items.

If 3,600 items are recorded for a single measurement, even if overwriting is enabled, the oldest data will not be overwritten, and recording will stop.

However, if the maximum recording time is exceeded, new data will overwrite the oldest data, even if the number of data items is less than 3,600.

The maximum recording times corresponding to different intervals are as follows:

Interval	10 seconds	20 seconds	30 seconds	1 minute	3 minutes	5 minutes	10 minutes
Maximum recording time	10 hours	20 hours	30 hours	60 hours	180 hours	300 hours	600 hours

*The standard interval is five minutes. The interval can be set using the data logger management program (sold separately).

(2) Alarm trend

When an alarm is triggered, this function records the changes in measured concentration for 30 minutes before and after the alarm occurred (one hour in total).

Alarm trend records PEAK values (minimum values for oxygen) over 5-second periods at 5-second intervals.

Records/retains the most recent eight data items.

If the number of items exceeds eight, new data will overwrite the oldest data.

(3) Alarm event

Records alarm occurrences as events.

This function records the time an alarm was triggered, the measurement target gas, and the type of alarm event.

Records/retains the most recent 100 data items.

If the number of items exceeds 100, new data will overwrite the oldest data.

(4) Trouble event

Records fault alarm occurrences as events.

This function records the time a fault alarm was triggered, the measurement target gas, device information, and the type of trouble event.

Records/retains the most recent 100 data items.

If the number of items exceeds 100, new data will overwrite the oldest data.

(5) Calibration history

Records data when calibration is performed.

This function records calibration time, concentration values before and after calibration, and calibration errors.

Records/retains data items for the most recent 100 calibrations.

If the number of calibrations exceeds 100, new data will overwrite the oldest data.

NOTE

- ▶ Communication mode will start automatically if the power is turned on, the date and time or battery level/alarm pattern is displayed, and the product infrared communication port faces in a direction that enables IrDA communication. You can also enter communication mode by pressing the AIR and POWER/MODE buttons at the same time with the product infrared communication port facing in a direction that enables IrDA communication.
 - ▶ A fault alarm will be triggered if no communication connection can be confirmed for a preset duration in communication mode. If this occurs, either repeat the attempt to establish a communication connection or turn off the power for the product.
-

11-2. Terminology

ppm	Indicates gas concentration in units of parts per million by volume.
%	Indicates gas concentration in units of parts per hundred by volume.
Calibration	Determining correlation between product readout values, display values, and setting values with actual values using calibration gas
Cumulative value	This is the time-weighted average for one hour. The duration for which the gas has been present is multiplied by the carbon monoxide concentration value. After the sum of this result (value) is calculated, it is divided by the number of hours to provide the exposure amount per hour.
TWA	Acronym for Threshold Limit Value Time Weighted Average Time-weighted average concentrations of a harmful substance considered to have no adverse health effects in nearly all workers, even with repeated exposure, during normal work for 8 hours per day or 40 hours per week
STEL	Acronym for Threshold Limit Value Short Term Exposure Limit Concentrations of a harmful substance considered to have no adverse health effects in workers, even with continuous exposure for 15 minutes, provided daily exposure does not exceed the TWA
Self-latching	Configuration in which an alarm persists, once triggered, unless reset, even when alarm conditions no longer apply
Auto reset	Configuration in which an alarm stops automatically after being triggered when alarm conditions no longer apply

Revision History

Issue	Revision details	Issue date
0	First issue * This Technical Manual corresponds to Operation Manual (PT0E-1890)	January 24, 2020

Declaration of Conformity

We, **RIKEN KEIKI CO., LTD.**

2-7-6, Azusawa, Itabashi-ku,
Tokyo 174-8744 Japan

declare in our sole responsibility that the following
product conforms to all the relevant provisions.

Product Name : Portable Gas Monitor
Model Name : OX-04,OX-04G,HS-04,CO-04,CX-04,SC-04
Council Directives : EMC : 2014/30/EU

ATEX : 2014/34/EU

RoHS : 2011/65/EU

Applicable Standards : EMC : EN 50270:2015 (Type2)
EN 61326-1:2013
IEC 61326-1:2012

ATEX : EN60079-0:2018
EN60079-11:2012

RoHS : EN50581(2012)

Name and address of the ATEX Notified Body : DEKRA Certification B.V (NB 0344)
Meander 1051, 6825 MJ Arnhem
P.O.Box 5185,6802 ED Arnhem
The Netherlands

Number of the EU type examination certificate : DEKRA 19ATEX0097
17 October 2019

Name and address of the ATEX Auditing Organization : DNV GL Presafe AS (NB 2460)
Veritasveien 3
1363 Høvik
Norway

The Marking of the equipment or protective system shall include the
following : II 1G Ex ia II C T4/T3 Ga

Year to begin affixing CE Marking : 2019

Place: TOKYO, Japan

Signature: 
Full name: Tetsuya Kawabe

Date: Nov. 25, 2019

Title: Director,Quality control center