

















ANTENNAS | MIMO-4-19 SERIES

9-IN-1 TRANSPORTATION & AUTOMOTIVE ANTENNA

617 – 7200 MHz; 4x4 LTE/5G (MIMO), 6 dBi; 4x4 Wi-Fi (MIMO), 6.5 dBi; GPS/GLONASS, 21 dBi



 617 – 960 MHz 1427 – 1517 MHz 1710 – 2700 MHz 3400 – 4200 MHz 5000 – 6000 MHz	 LTE: 6 dBi Wi-Fi: 6.5 dBi GPS: 21 dBi	 Increase X Mb/s	 Omni- Directional	 5G Coverage	 4G LTE	 Urban
 2.4 – 2.5 GHz 5.0 – 7.2 GHz	 CBRS Band	 4x4 MIMO	 -40°C to +80°C	 IP 69K	 GPS Included	 Rural/Farm
<ul style="list-style-type: none"> • 9-in-1 High performance multi frequency automotive antenna • Ultra-wideband coverage from 617 to 6000 MHz for cellular • 4x4 MIMO LTE/5G, 4x4 MIMO Wi-Fi & GPS/GLONASS • Robust and weather resistant antenna with an IP 69K rating • Ideal for transportation and marine implementation • Multi mounting options for ease of installation 						 Marine
						 Vehicle
						 Smart Meter

APPLICATION AREAS

Product Overview

The MIMO-4-19 is a 9-in-1 high performance, multi frequency antenna within a single housing. The antenna provides four cellular, four Wi-Fi and a GPS/GLONASS antenna. The four cellular MIMO antennas offer wideband coverage from 617 to 6000 MHz, covering contemporary LTE/4G and 5G bands for future proof implementation. The ultra-wideband performance of the cellular antennas allows it to be used across different operators and technologies and is ready for future cellular technologies up to 6 GHz for 5G applications, as well as Wi-Fi application from 5 to 6 GHz.

The antenna also provides four dual-band Wi-Fi antennas, providing concurrent 2.4 GHz and 5 to 7.2 GHz on each antenna for 4x4 MIMO capability. The MIMO-4-19 exceeds the performance of most competitors due to the attention to the design of this high-performance antenna. The radiation patterns of all radiating elements, provide an excellent balance between omni-directionality, pattern diversity and good radiation abilities at the desired elevation. This is an important criterion for the transportation and marine market, which the antenna was specifically designed for. Main applications are for commercial/industrial vehicles, marine, M2M and other IoT systems using a wide range of radio technologies, while remaining futureproof over the wide frequency band.

Features

- Ultra-wideband operation from 617 to 6000 MHz for cellular
- Features 4 x cellular, 4 x Wi-Fi and 1 x GPS/GLONASS antenna
- Ultra-rugged mechanical design to allow for IP 69K rating
- Ground plane independent; antenna design with internal ground
- Multiple mounting options available for ease of installation

Application Areas

- Transport broadband cellular and Wi-Fi distribution, automation and telemetry for busses, utility, trucking and public safety vehicles
- Industrial factory automation, robotic machinery and other M2M systems telemetry
- Farming & Agricultural automation such as M2M & IoT
- Broadband cellular to Wi-Fi distribution for Marine/Boats
- Mining vehicles & machinery communications, telemetry, and automation (M2M & IoT)



Frequency Bands

The MIMO-4-19 is an omni-directional antenna that works from 617 – 960 MHz | 1427 – 1517 MHz | 1710 – 2700 MHz | 3400 – 4200 MHz | 5000 – 6000 MHz | and the following Wi-Fi frequency bands | 2400 – 2500 MHz | and | 5000 – 7200 MHz |

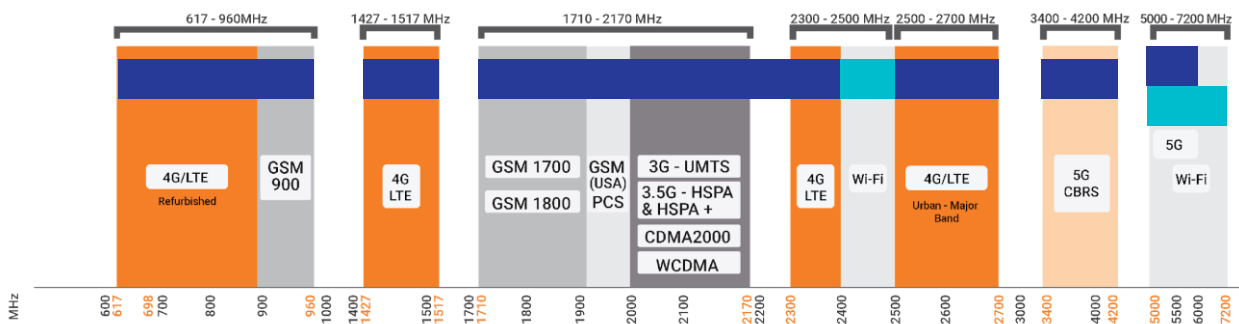

Indicates the 5G/LTE bands on which MIMO-4-19 works Indicates the WI-FI bands on which MIMO-4-19 works

Antenna Derivatives

Product Order Code (SKU)	A-MIMO-0004-V1-19-B	A-MIMO-0004-V1-19-W
Radome Colour	Black	White
Radome Material	PC+ABS (Halogen Free)	UV Stable ASA
Ports	9	9
SISO/MIMO	4x4 MIMO	4x4 MIMO
Coax Cable Type	RTK-031 – LTE, Wi-Fi & GPS	RTK-031 – LTE, Wi-Fi & GPS
Coax Cable Length	2m – LTE, Wi-Fi & GPS	2m – LTE, Wi-Fi & GPS
Connector Type	SMA (M) – LTE, Wi-Fi & GPS	SMA (M) – LTE, Wi-Fi & GPS
EAN	6009710925348	6009710925362
E-Mark Certification Number	E1*10R06/02*9871*00	E1*10R06/02*9871*00

**The coax cable & connector are factory mounted to the antenna*

Electrical Specifications - Cellular

Frequency Bands:	617 – 960 MHz 1427 -1517 MHz 1710 -2700 MHz 3400 – 4200 MHz 5000 – 6000 MHz
Gain (Max):	-0.5 dBi @ 617 – 960 MHz 3.5 dBi @ 1427 – 1517 MHz 5.5 dBi @ 1710 – 2700 MHz 5.5 dBi @ 3400 - 4200 MHz 6 dBi @ 5000 - 6000 MHz
VSWR:	<2:1
Feed Power Handling:	10 W
Input Impedance:	50 Ohm (nominal)
Polarisation:	Linear Vertical
Coax Cable Loss:	0.56 dB/m @ 900 MHz 0.785 dB/m @ 1800 MHz 1.2 dB/m @ 3000 MHz
DC Short:	Yes

Electrical Specifications - GPS/Glonass

Frequency Range (GPS):	1575.42MHz/1600MHz
Gain (Max):	21+/-2dBi
VSWR:	≤1.5:1
DC Voltage:	2.7-3.3 V
DC Current:	5-15mA
Noise Figure:	≤1.5 dB
Nominal Impedance:	50 Ω
Polarisation:	RHCP
Filter Out Band Attenuation:	12dB Min f0+50MHz, 16dBi Min f0-50MHz
Max. Power:	50 W
Coax Cable Loss:	0.71 dB/m @ 1500 MHz

Electrical Specifications - Wi-Fi

Frequency:	2400 - 2500 MHz 5000 – 7200 MHz
Gain (Max):	5 dBi @ 2400 - 2500 MHz 6.5 dBi @ 5000 - 7200 MHz
VSWR:	< 2.5:1
Feed Power Handling:	10 W
Nominal Input Impedance:	50 Ohm (nominal)
Coax Cable Loss:	0.91 dB/m @ 2400 MHz 1.65 dB/m @ 5800 MHz
Path to Ground:	Yes

Product Box Contents

Antenna:	A-MIMO-0004-V1-19
Mounting Bracket*:	Ø25 Threaded Spigots (Up to 70mm clamping thickness), Pole/Wall Mounting Bracket & Adhesive Surface Mounting
Adapters:	4 x RP-SMA(M) To SMA (F)

Mechanical Specifications

Product Dimensions	Ø160 mm x 65 mm
Packaged Dimensions:	230 mm x 220 mm x 150 mm
Weight:	0.94 kg
Packaged Weight:	1.46 kg
Mounting Type*:	Pole, Wall, Surface, Marine and Optional Magnetic mount

Environmental Specifications, Certification & Approvals

Wind Survival:	≤220 km/h
Temperature Range (Operating):	-40°C to +80°C
Environmental Conditions:	Outdoor/Indoor
Water Ingress Protection Ratio/Standard:	IP 69K
Salt Spray:	MIL-STD 810G/ASTM B117
Operating Relative Humidity:	Up to 98%
Storage Humidity:	5% to 95% - non-condensing
Storage Temperature:	-40°C to +80°C
Enclosure Flammability Rating:	UL 94-HB
Impact Resistance:	IK 10**
Product Safety & Environmental:	Complies with CE and RoHS standards

*Pole/wall mount for non-mobility applications

**IK 08 for pole/wall mount options



Antenna Performance Plots

VSWR: Cellular Antenna

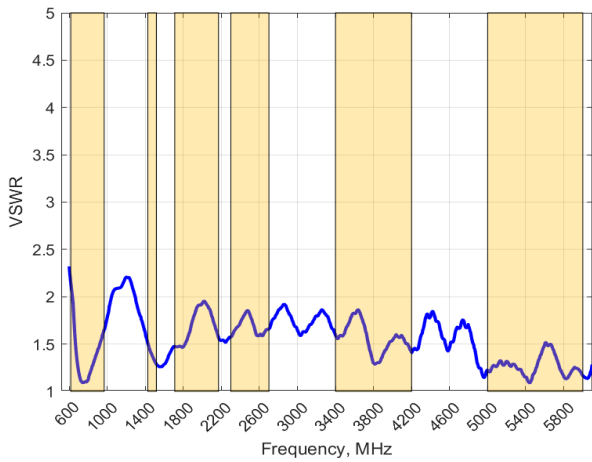

Voltage Standing Wave Ratio (VSWR)*

VSWR is a measure of how efficiently radio-frequency power is transmitted from a power source, through a transmission line, into a load. In an ideal system, 100% of the energy is transmitted which corresponds to a VSWR of 1:1.

The MIMO-4-19 delivers superior performance across all bands with a VSWR of <2:1.

*VSWR measured with 2m low loss cable.

GAIN (EXCLUDING CABLE LOSS): Cellular Antenna

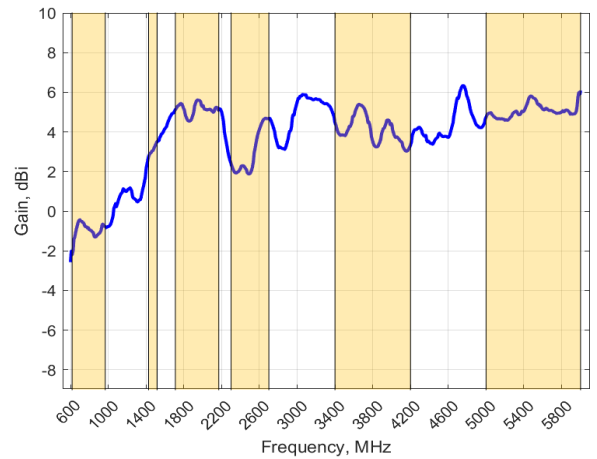

Gain* in dBi

6 dBi is the peak gain across all bands from 617 – 6000 MHz

Gain @ 617 – 960 MHz:	-0.5 dBi
Gain @ 1427 – 1517 MHz:	3.5 dBi
Gain @ 1710 – 2700 MHz:	5.5 dBi
Gain @ 3400 – 4200 MHz:	5.5 dBi
Gain @ 5000 – 6000 MHz:	6 dBi

*Antenna gain measured with polarisation aligned standard antenna on a 600mm ground plane.

VSWR: Wi-Fi Antenna

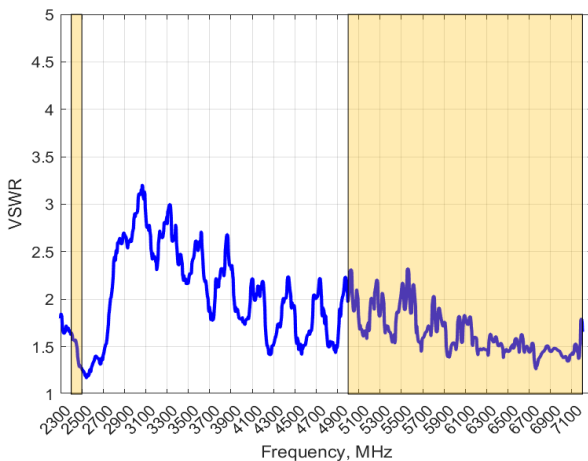

Voltage Standing Wave Ratio (VSWR)*

VSWR is a measure of how efficiently radio-frequency power is transmitted from a power source, through a transmission line, into a load. In an ideal system, 100% of the energy is transmitted which corresponds to a VSWR of 1:1.

The MIMO-4-19 delivers superior performance across all bands with a VSWR of <2.5:1.

*VSWR measured with 2m low loss cable.

GAIN (EXCLUDING CABLE LOSS): Wi-Fi Antenna

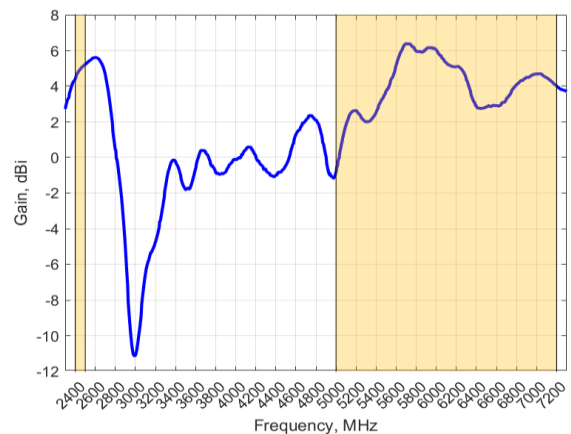

Gain* in dBi

6.5 dBi is the peak gain across all bands from 2400 – 2500 MHz and 5000 – 7200 MHz

Gain @ 2400 – 2500 MHz:	5 dBi
Gain @ 5000 – 7200 MHz:	6.5 dBi

*Antenna gain measured with polarisation aligned standard antenna on a 600mm ground plane.

MIMO Radiation Patterns

Azimuth: 617 – 960 MHz

Elevation: 617 – 960 MHz

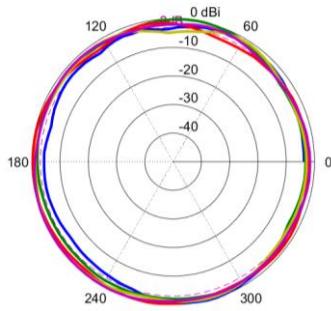

- 617 MHz
- 698 MHz
- 800 MHz
- 900 MHz
- 960 MHz

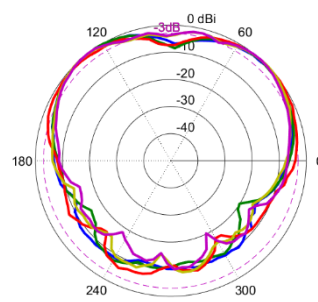

- 617 MHz
- 698 MHz
- 800 MHz
- 900 MHz
- 960 MHz

Azimuth: 1427 – 1517 MHz

Elevation: 1427 – 1517 MHz

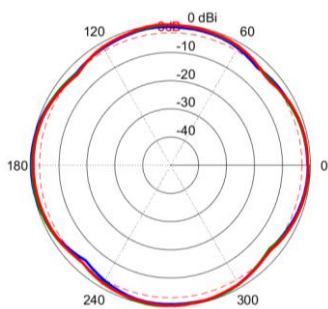

- 1427 MHz
- 1472 MHz
- 1517 MHz

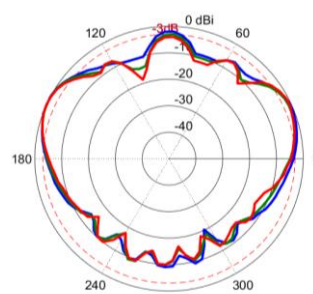

- 1427 MHz
- 1472 MHz
- 1517 MHz

Azimuth: 1710 – 2170 MHz

Elevation: 1710 – 2170 MHz

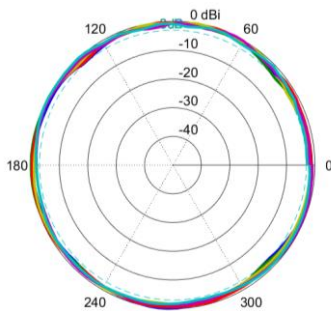

- 1710 MHz
- 1800 MHz
- 1900 MHz
- 2000 MHz
- 2100 MHz
- 2170 MHz

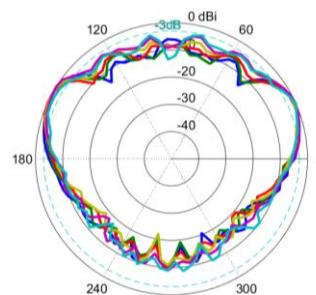

- 1710 MHz
- 1800 MHz
- 1900 MHz
- 2000 MHz
- 2100 MHz
- 2170 MHz

Azimuth: 2300 – 2700 MHz

Elevation: 2300 – 2700 MHz

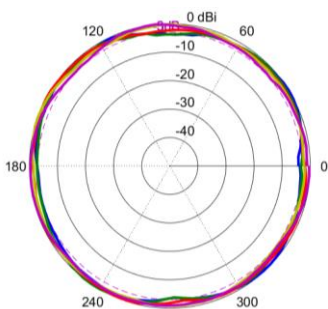

- 2300 MHz
- 2400 MHz
- 2500 MHz
- 2600 MHz
- 2700 MHz

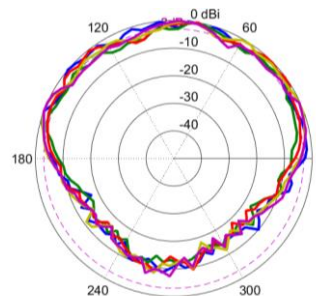

- 2300 MHz
- 2400 MHz
- 2500 MHz
- 2600 MHz
- 2700 MHz

Azimuth: 3400 – 4200 MHz

Elevation: 3400 – 4200 MHz

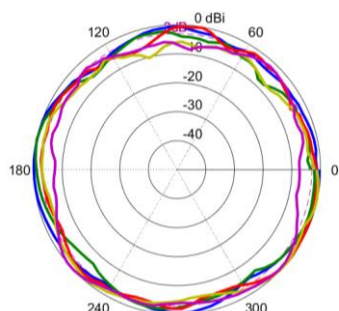

- 3400 MHz
- 3600 MHz
- 3800 MHz
- 4000 MHz
- 4200 MHz

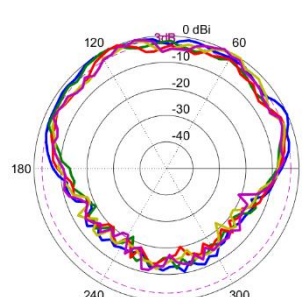

- 3400 MHz
- 3600 MHz
- 3800 MHz
- 4000 MHz
- 4200 MHz

Azimuth: 5000 – 6000 MHz

Elevation: 5000 – 6000 MHz

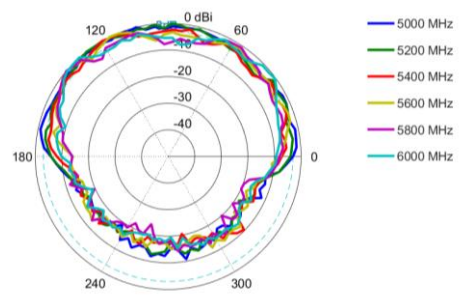
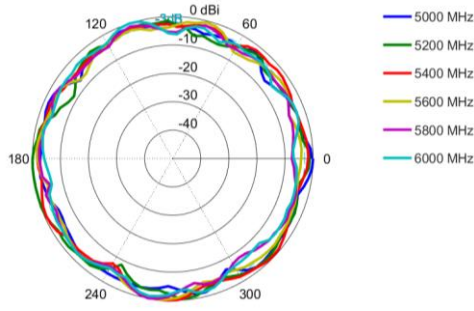

Radiation Patterns – Wi-Fi

Azimuth: 2400 – 2500 MHz

Elevation: 2400 – 2500 MHz

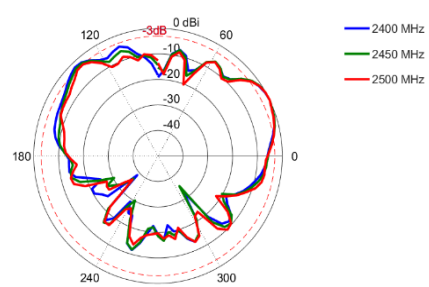
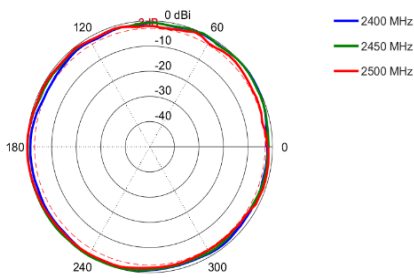

Azimuth: 5000 – 6000 MHz

Elevation: 5000 – 6000 MHz

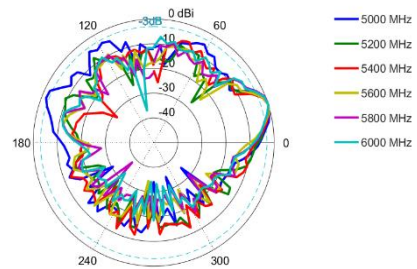
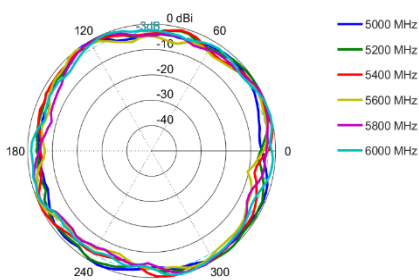

Azimuth: 6300 – 7200 MHz

Elevation: 6300 – 7200 MHz

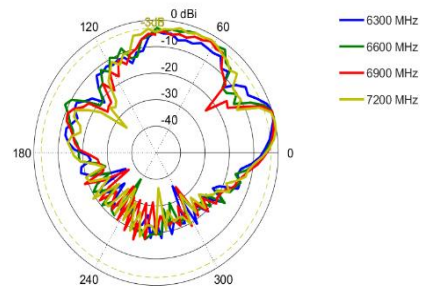
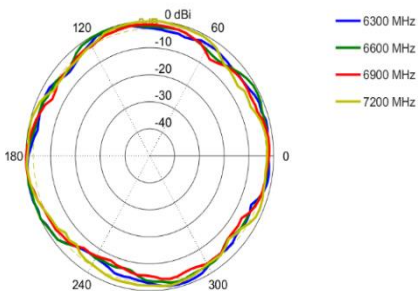

Radiation Patterns – GPS

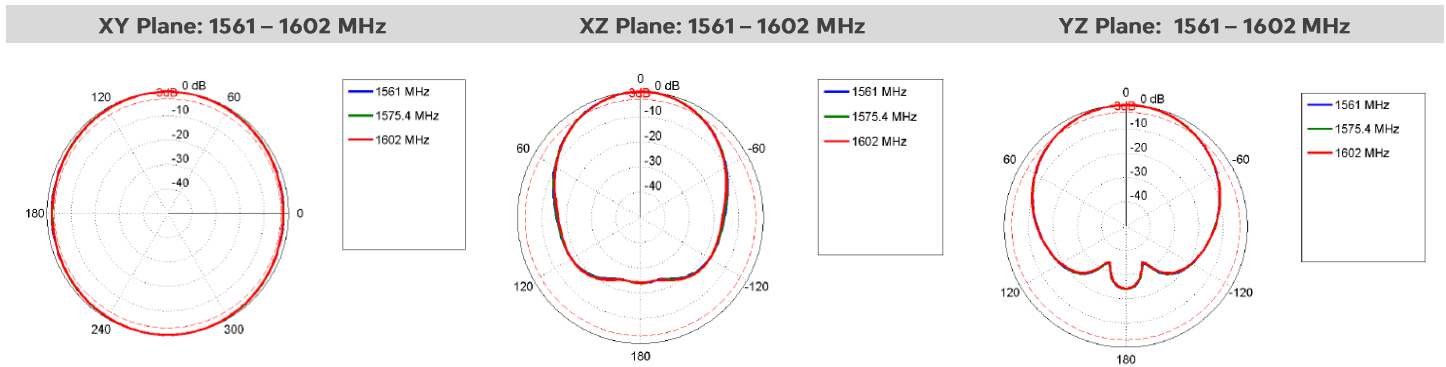

Technical Drawings

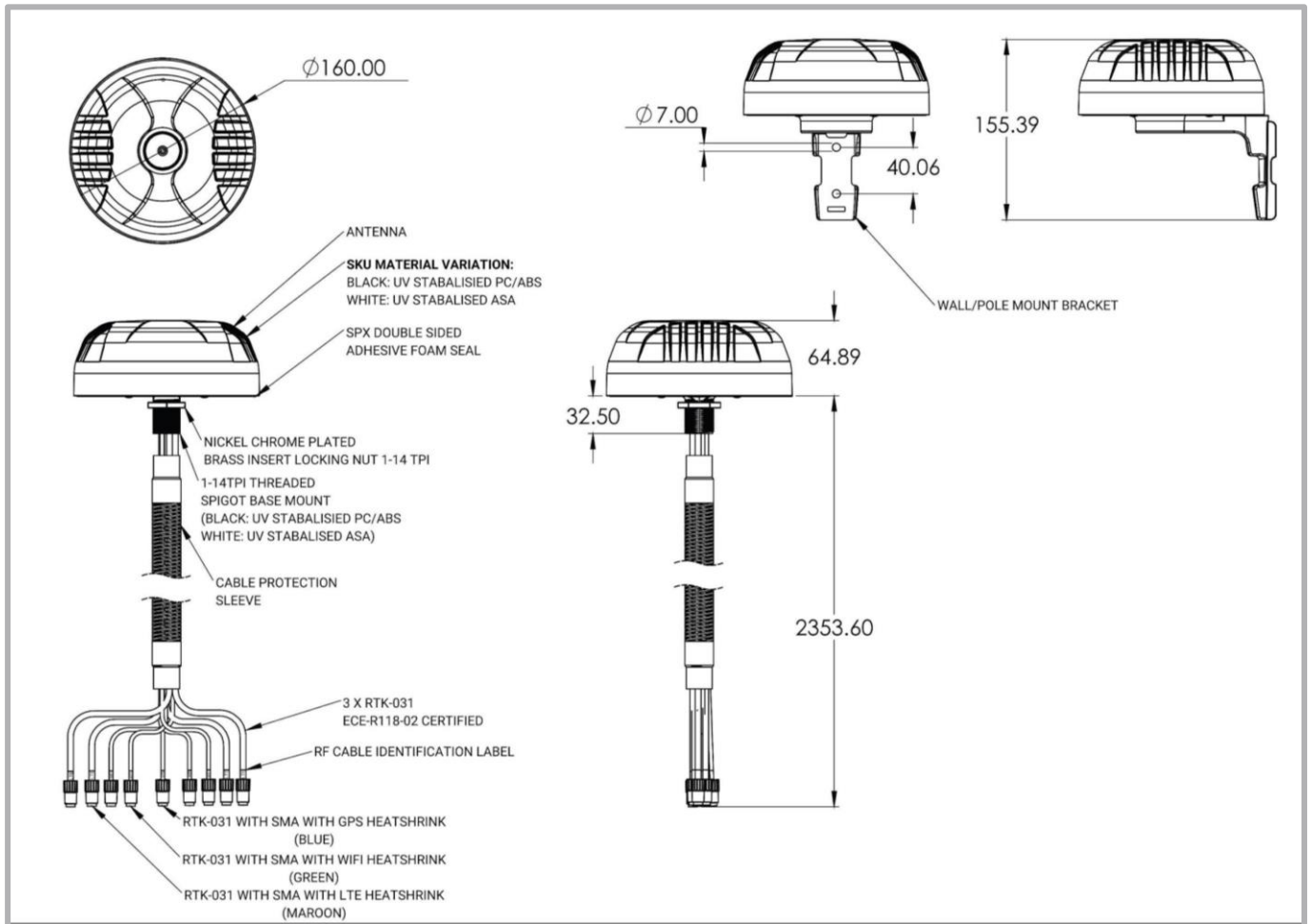

Mounting Options

Many Mounting Possibilities – included as standard

Poynting's MIMO-4 antenna range provides easy installation with the multiple mounting options. This includes as standard:

- Vertical Pole Mount (inner & outer mounting for smaller and larger poles)
- Horizontal Pole Mount (e.g., marine rails)
- Magnetic Mount (Optional)
- Wall Mount
- Surface Mount (Double Sided Tape)
- Marine Mount

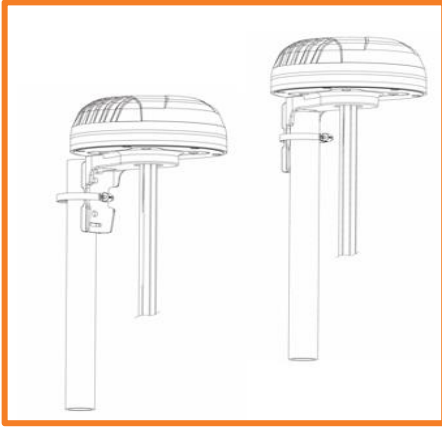

Vertical Pole Mount

Pole/Wall Mounting bracket (included)

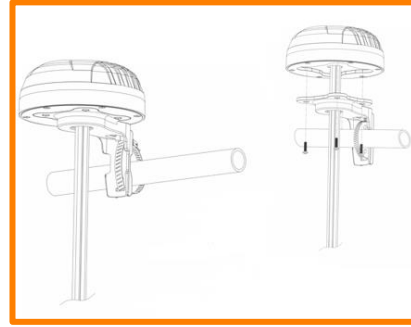

Horizontal Pole Mount

Pole/Wall Mounting bracket (included)

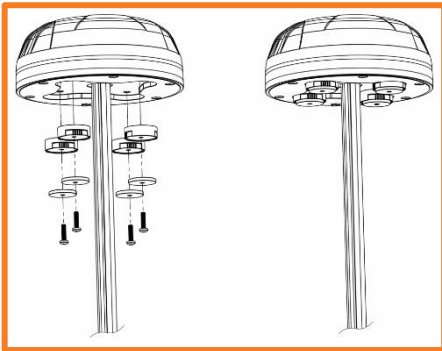

Magnetic Mount (Optional)

Magnetic Base Kit (not included)

For temporary and low mobility installations.

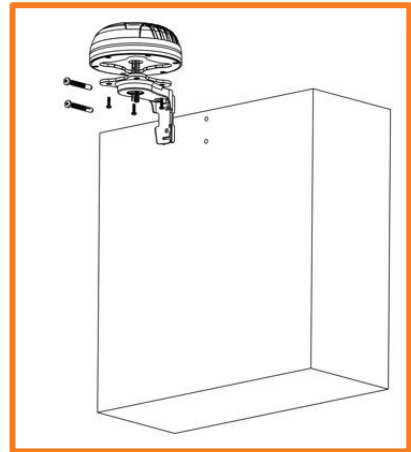

Wall Mount

Pole/Wall Mounting bracket (included)

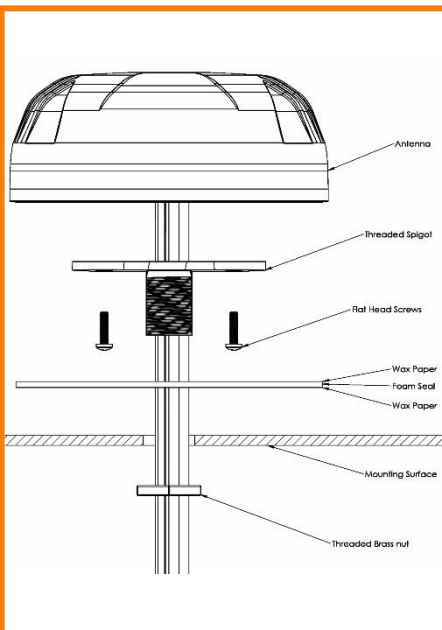

Surface Mount

Adhesive Surface Mounting (included) or can also be directly secured with longer M4 bolts (not included) to the female threaded inserts located in the antenna base.

Short and long spigots provided for clamping thicknesses of 22mm or less and 70mm or less respectively.

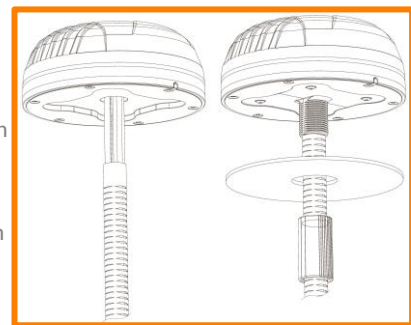

Marine Mount Preparation

Preparation for marine mount using removable female threaded spigot (included)

Connector re-crimping will be required after passing cables through marine bracket.

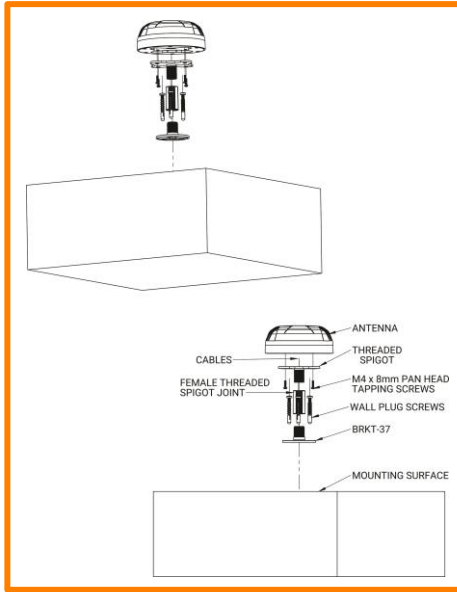

Marine Mount

Mounts to standard marine bracket (BRKT-37: Flat Mount)

Additional Accessories



A-MBK-0003-V1 – NOT PROVIDED

Optional Magnetic Base Kit with four magnets for magnetic mount option

See accessories technical specifications on www.poynting.tech

CONTACT POYNTING

Poynting Antennas (Pty) Ltd - Head Office

Unit 4, N1 Industrial Park,
Landmarks Avenue,
Samrand, 0157, South Africa

Phone: +27 (0) 12 657 0050

E-mail: info@poynting.tech

International Email: sales-global@poynting.tech

Poynting Europe

Regus Business Center Neue Messe Riem
Kronstadter Straße 4
81677 München
Germany

Phone: +49 89 7453 9002

E-mail: sales-europe@poynting.tech

Poynting USA

1804 Owen Court, Suite 104,
Mansfield,
TX 76063
USA

Phone: +1 817 533-8130

E-mail: sales-us@poynting.tech