









## ANTENNAS | PUCK-3 SERIES

# 3-IN-1 TRANSPORTATION & IOT/M2M ANTENNA

617 – 4200 MHz, LTE (SISO); 2400 – 7200 MHz, Wi-Fi (SISO); GPS/GLONASS



 617 – 960 MHz 1427 – 1517 MHz 1710 – 2700 MHz 3400 – 4200 MHz	 LTE: 8 dBi Wi-Fi: 7.5 dBi GPS: 21 dBi	 GPS Included	 Omni-Directional	 4G LTE	 5G
 Machine to Machine	 CBRS Band	 2.4 – 2.5 GHz 5.0 – 7.2 GHz	 IP69K	 -40°C to +80°C	 Chemical Protection

**APPLICATION AREAS**

-  Urban
-  Rural/Farm
-  Marine
-  Vehicle
-  Meter

- 3-in-1 LTE high performance multi frequency antenna
- 2G/3G/4G/LTE/5G antenna
- LTE (SISO), Wi-Fi (SISO) and GPS/GLONASS
- Wideband – covers wide frequency band, incl. 3.5 GHz CBRS band
- Robust, vandal resistant and waterproof (IP69K)
- Ideal for transportation, marine and IoT/M2M use
- Ultra-versatile mounting options for easy installation

## Product Overview

Poynting's new PUCK range offers a small profile antenna for use in the IoT/M2M, Smart Meter, Smart Utilities, Transportation, Marine and the Agricultural/Farming markets. The PUCK-3 consists of a 3-in-1 antenna system within a single housing, featuring SISO LTE, SISO Wi-Fi and GPS/GLONASS. The Cellular antenna (for 2G/3G/4G) covers the 617MHz to 4200MHz band, this includes the most popular international LTE bands. The antenna provides a dual-band Wi-Fi antenna offering concurrent 2.4GHz and 5GHz bands, capable of 802.11n and 802.11ac/ax. The third antenna is a high-performance active GPS/GLONASS system operating at temperatures as low as -40°C. The PUCK exceeds the performance of many competitors due to the attention to design of this high-performance antenna. The radiation patterns of all radiating elements provide an excellent balance between omnidirectionality, pattern diversity and good radiation abilities at the desired elevation, which is often overlooked in such a small size antenna. Despite its small size, this antenna provides excellent performance especially at the higher frequency bands, where performance is critical for LTE throughput and connection stability.

## Features

- Small & Low-profile (Ø100mm x h 36mm)
- Careful mechanical design provides ruggedness, corrosion, water and dust resistance (IP69K)
- Fire Resistant
- UV Stable Enclosure
- 5G Ready – includes the 3.2 GHz to 3.8 GHz CBRS Band
- Easy installation; multi-implementation options available:
  - Spigot Mount
  - Magnetic Mount
  - Adhesive Tape Mount
  - Bracket Mount

## Application Areas

- Smart utilities: Smart Power, Gas & Water Metering
- Smart Buildings: Climate control, access control, security, irrigation
- Industrial factory automation, robotic machinery and other M2M systems
- Digital Signage
- Warehouses & Logistic systems
- Transport (Busses, Utility & Public Safety)
- Mining Vehicles & Machinery communications, telemetry and automation (M2M & IoT)
- Agricultural machinery
- Marine: small boats, yachts near to coastlines or inner waters



### Frequency Bands

The PUCK-3 is an omni-directional antenna that works from 617 – 960 MHz | 1427 – 1517 MHz | 1710 – 2700 MHz | 3400 – 4200 MHz | and the following Wi-Fi frequency bands | 2400 – 2500 MHz | and | 5000 – 7200 MHz |

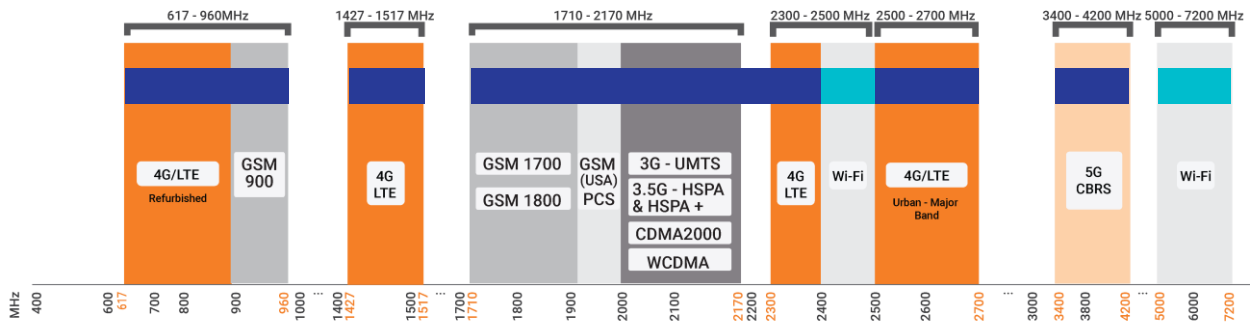

Indicates the LTE bands on which PUCK-3 works

Indicates the WI-FI bands on which PUCK-3 works

### Antenna Overview

Ports	1	2	3
SISO / MIMO	SISO	SISO	N/A
Frequency Bands	617 MHz - 4200 MHz	2.4-2.5 GHz & 5-7.2 GHz	1575.42 MHz/1600 MHz
Peak Gain	8 dBi	7.5 dBi	21 dBi
Coax Cable Type	RTK-031	RTK-031	RTK-031
Coax Cable Length	2m	2m	2m
Connector Type	SMA (M)	SMA (M) (RP-SMA Adapter included)	SMA (M)

*\*The coax cable & connector are factory mounted to the antenna*

### Electrical Specifications - Cellular

Frequency Bands:	617 – 960 MHz 1427 – 1517 MHz 1710 – 2700 MHz 3400 – 4200 MHz
Gain (Max):	-1 dBi @ 617-960 MHz 2 dBi @ 1427-1527 MHz 7 dBi @ 1710-2700 MHz 8 dBi @ 3400-4200 MHz
VSWR:	≤2.5:1 Across 85% of the bands
Feed Power Handling:	10 W
Input Impedance:	50 Ohm (nominal)
Polarisation:	Linear Vertical
Coax Cable Loss:	0.56 dB/m @ 900 MHz 0.785 dB/m @ 1800 MHz 1.2 dB/m @ 3000 MHz
DC Short:	Yes

### Electrical Specifications - GPS/Glonass Antenna

Frequency Range (GPS):	1575.42MHz/1600MHz
Gain (Max):	21+/-2dBi
VSWR:	≤1.5:1
DC Voltage:	2.7-3.3 V
DC Current:	5-15mA
Noise Figure:	≤1.5 dB
Nominal Impedance:	50 Ω
Polarisation:	RHCP
Filter Out Band Attenuation:	12dB Min f0+50MHz, 16dBi Min f0-50MHz
Cable:	RTK-031
Connector:	SMA (M)
Voltage:	2.7 - 3.3V
Max. Power-W:	50
Coax cable loss:	0.71 dB/m @ 1500 MHz

### Electrical Specifications – Wi-Fi

Frequency:	2400-2500 MHz 5000–7200 MHz
Gain (Max):	2 dBi @ 2400-2500 MHz 7.5 dBi @ 5000–7200 MHz
VSWR Port 1 & 2:	≤2:1 across 90% of the bands
Feed power handling:	10 W
Nominal input impedance:	50 Ohm (nominal)
Polarisation:	Linear Vertical
Coax Cable Loss:	0.91 dB/m @ 2400 MHz 1.65 dB/m @ 5800 MHz
Path to Ground:	Yes

### Product Box Contents

Antenna:	A-PUCK-0003-V1-01
Mounting Bracket:	Ø20 Threaded Spigots (Up to 60mm clamping thickness), Adhesive Surface Mounting & Magnetic Mount
Adapters:	1x RP-SMA(M) To SMA (F)

### Ordering Information

Commercial Name:	PUCK-3
Order Product Code:	A-PUCK-0003-V1-01
EAN Number:	6009880915286
EU Homologation Number:	E1*10R06/01*9551*00

### Mechanical Specifications

Product Dimensions	Ø99.3 mm x 36 mm
Packaged Dimensions:	150 mm x 150mm x 120mm
Weight:	0.426kg
Packaged Weight:	0.557kg
Radome Material:	PC+ABS (Halogen free)
Radome Colour:	Black
Mounting Type:	Ø20 Threaded Spigot, Pole, Wall, Surface and Magnetic mount

### Environmental Specifications, Certification & Approvals

Wind Survival:	≤220 km/h
Temperature Range (Operating):	-40°C to +80°C
Environmental Conditions:	Outdoor/Indoor
Water Ingress Protection Ratio/Standard:	IP69K
Salt Spray:	MIL-STD 810G/ASTM B117
Operating Relative Humidity:	Up to 98%
Storage Humidity:	5% to 95% - non-condensing
Storage Temperature:	-40°C to +80°C
Enclosure Flammability Rating:	UL 94-HB
Impact Resistance:	IK 10
Product Safety & Environmental:	Complies with CE and RoHS standards



**Antenna Performance Plots**

**VSWR: Cellular Antenna**

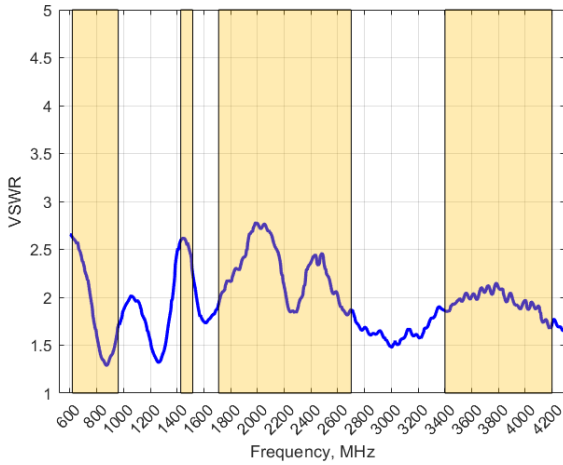

**Voltage Standing Wave Ratio (VSWR)\***

VSWR is a measure of how efficiently radio-frequency power is transmitted from a power source, through a transmission line, into a load. In an ideal system, 100% of the energy is transmitted which corresponds to a VSWR of 1:1.

The PUCK-3 delivers superior performance across all bands with a VSWR of  $\leq 2.5:1$  across 85% of the bands.

*\*Measured with 2m low loss cable, 650 x 650 mm ground plane, and unused ports terminated with 50Ω load.*

**VSWR: Wi-Fi Antenna**

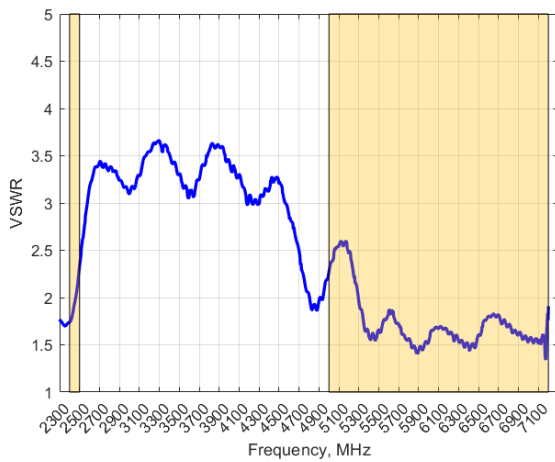

**Voltage Standing Wave Ratio (VSWR)\***

VSWR is a measure of how efficiently radio-frequency power is transmitted from a power source, through a transmission line, into a load. In an ideal system, 100% of the energy is transmitted which corresponds to a VSWR of 1:1.

The PUCK-3 delivers superior performance across all bands with a VSWR of  $\leq 2:1$  across 90% of the bands.

*\*Measured with 2m low loss cable, 650 x 650 mm ground plane, and unused ports terminated with 50Ω load.*

**GAIN (Excluding Cable Loss): Cellular Antenna**

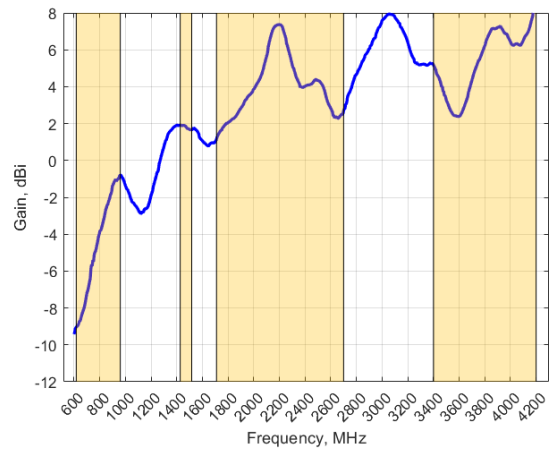

**Gain\* in dBi**

8 dBi is the peak gain across all bands from 617 – 4200 MHz

Gain @ 617 – 960 MHz:	-1 dBi
Gain @ 1427 – 1517 MHz:	2 dBi
Gain @ 1710 – 2700 MHz:	7 dBi
Gain @ 3400 – 4200 MHz:	8 dBi

*\*Antenna gain measured with polarisation aligned standard antenna*

**GAIN (Excluding Cable Loss): Wi-Fi Antenna**

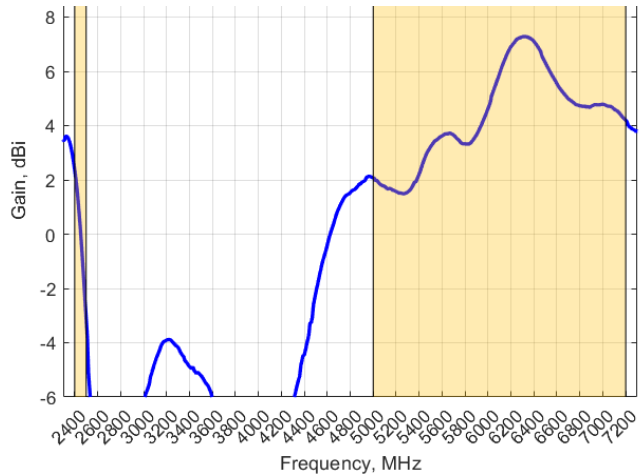

**Gain\* in dBi**

7.5 dBi is the peak gain across all bands from 2400 – 2500 MHz & 5000 – 7200 MHz

Gain @ 2400 – 2500 MHz:	2 dBi
Gain @ 5000 – 7200 MHz:	7.5 dBi

*\*Antenna gain measured with polarisation aligned standard antenna*

Technical Drawings

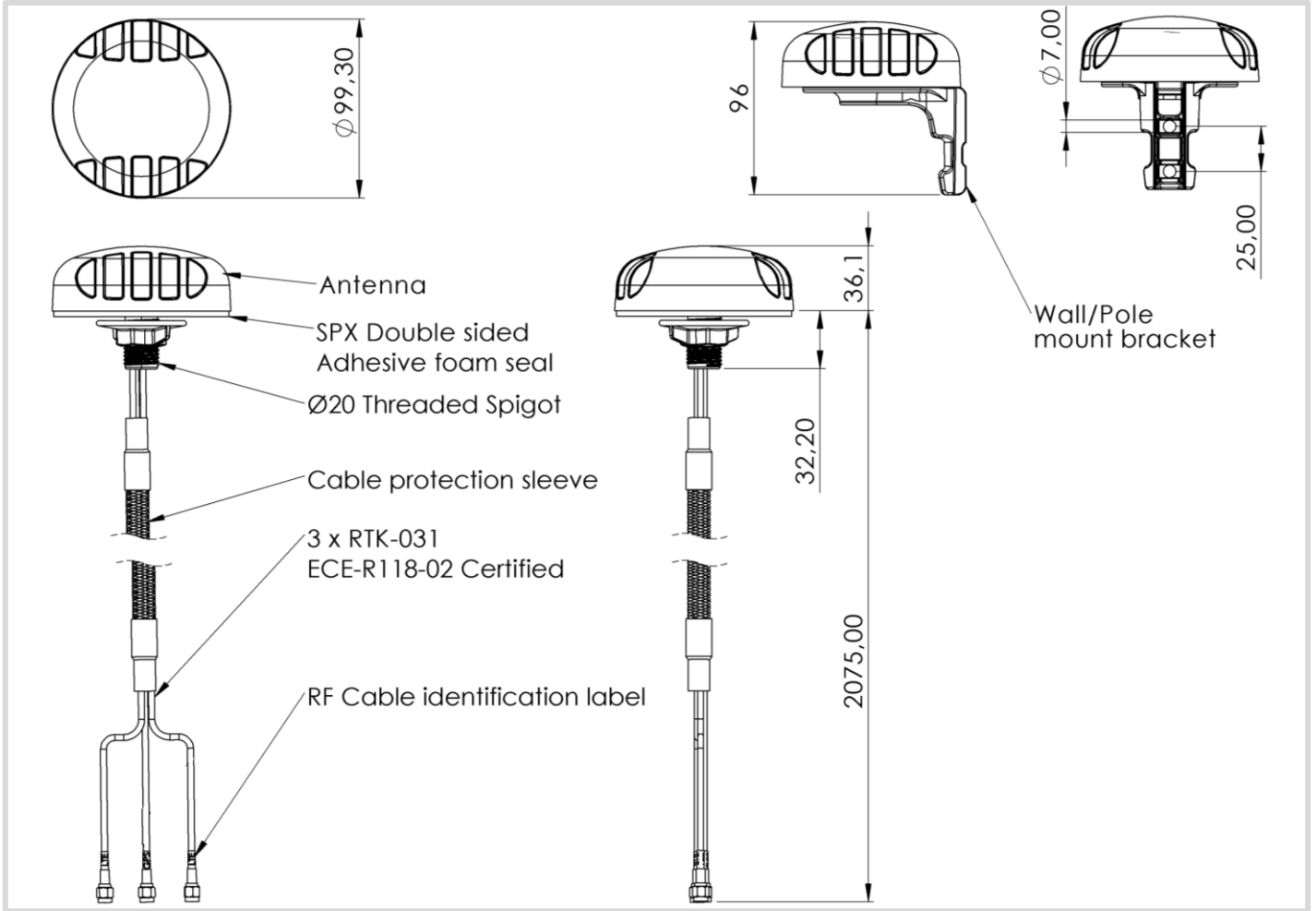

**Radiation Patterns - Cellular**

**Azimuth: 617 – 968 MHz**

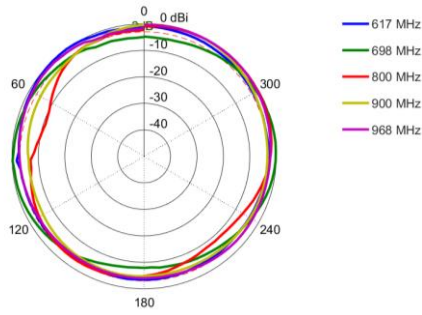

**Azimuth: 1427 – 1517 MHz**

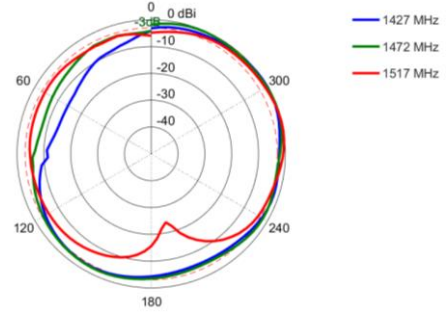

**Azimuth: 1710 – 2170 MHz**

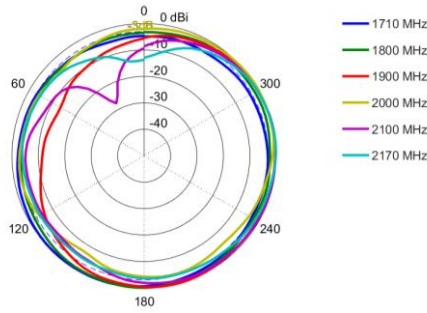

**Azimuth: 2300 – 2700 MHz**

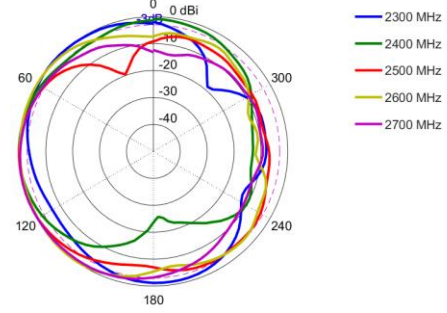

**Azimuth: 3400 – 3800 MHz**

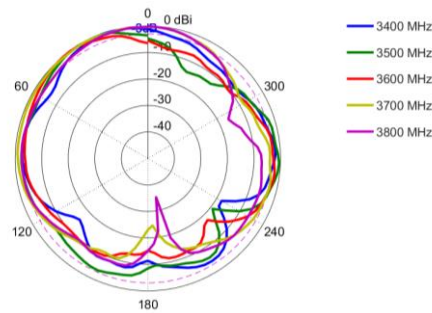

**Azimuth: 4000 – 4200 MHz**

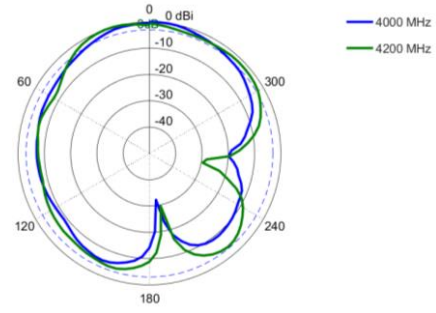

**Elevation: 617 – 968 MHz**

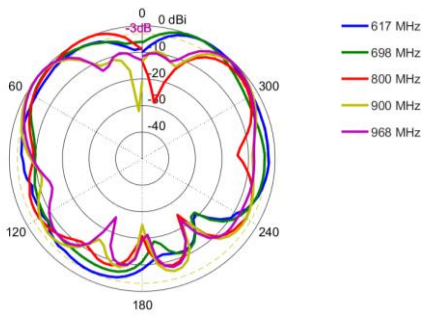

**Elevation: 1427 – 1517 MHz**

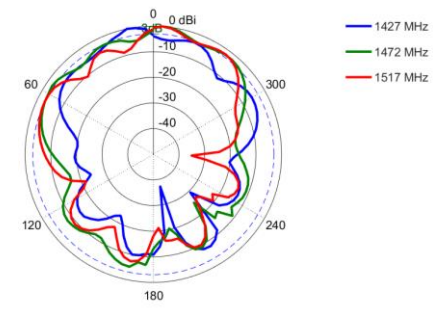

**Elevation: 1710 – 2170 MHz**

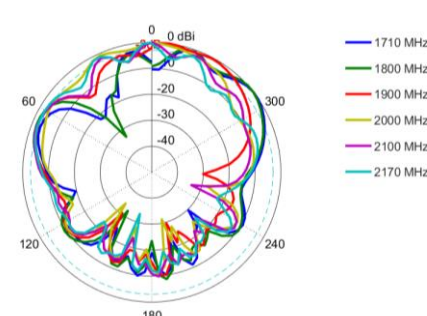

**Elevation: 2300 – 2700 MHz**

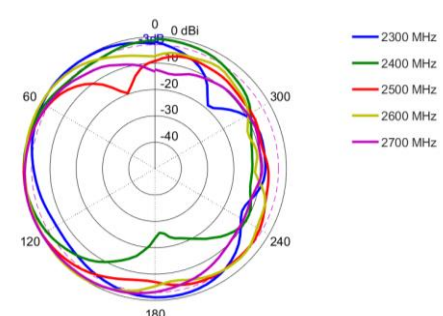

**Elevation: 3400 – 3800 MHz**

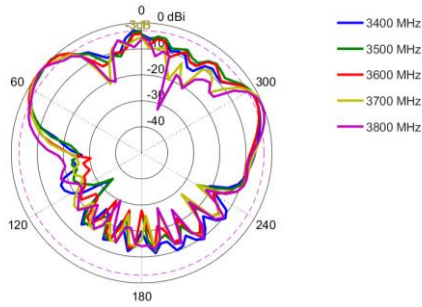

**Elevation: 4000 – 4200 MHz**

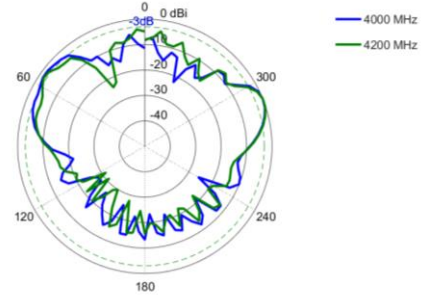

**Radiation Patterns – Wi-Fi**

**Azimuth: 2400 – 2500 MHz**

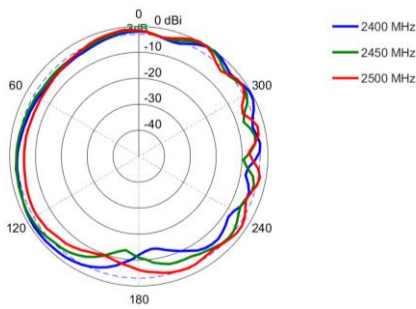

**Azimuth: 5000 – 5400 MHz**

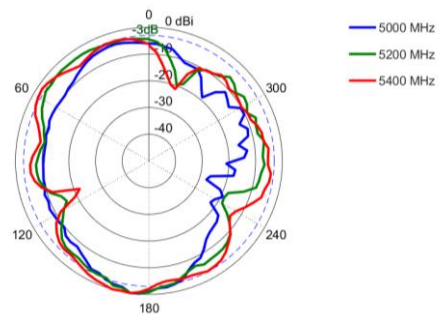

**Azimuth: 5600 – 5800 MHz**

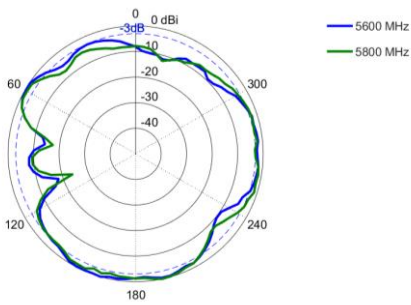

**Azimuth: 6300 – 7200 MHz**

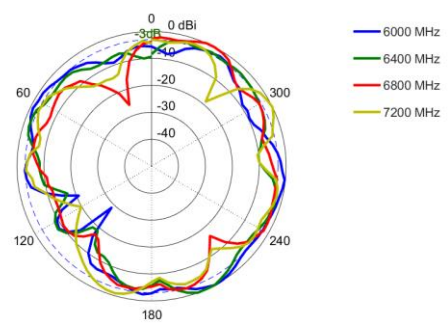

**Elevation: 2400 – 2500 MHz**

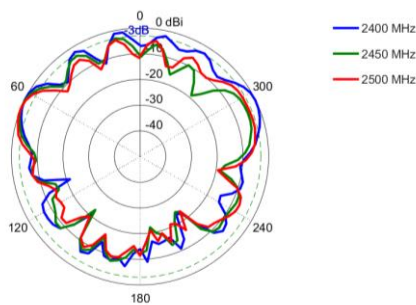

**Elevation: 5000 – 5400 MHz**

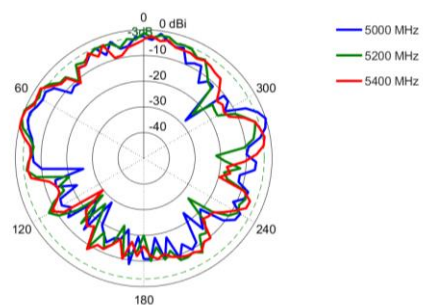

**Elevation: 5600 – 5800 MHz**

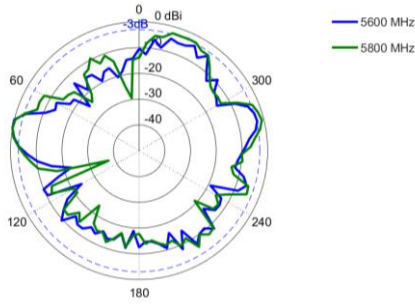

**Elevation: 6300 – 7200 MHz**

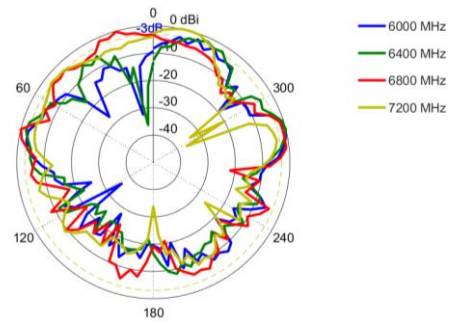

**Radiation Patterns – GPS**

**XY Plane: 1561–1602 MHz**

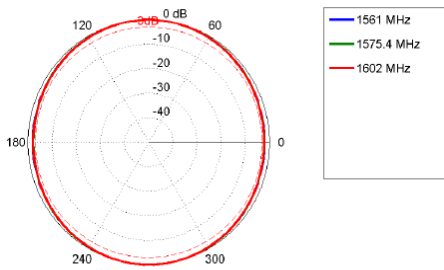

**XZ Plane: 1561–1602 MHz**

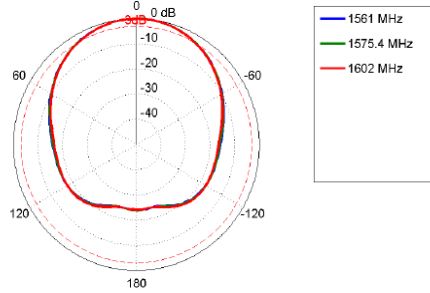

**YZ Plane: 1561–1602 MHz**

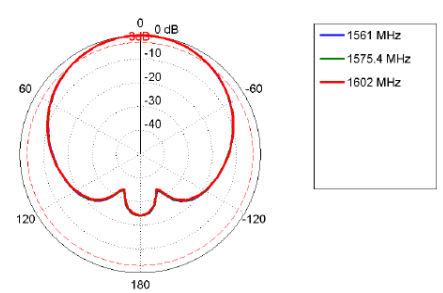



**Mounting Options**

**Many Mounting Possibilities – included as standard**

Poynting's new PUCK antenna range provides easy installation with the multiple mounting options. This includes as standard:

- Spigot Mount - two different lengths included (35mm & 75mm)
- Vertical Pole mount (inner & outer mounting for smaller and larger poles)
- Horizontal Pole Mount (e.g., marine rails)
- Magnetic Mount
- Surface Mount (Double Sided Tape)
- Wall Mount

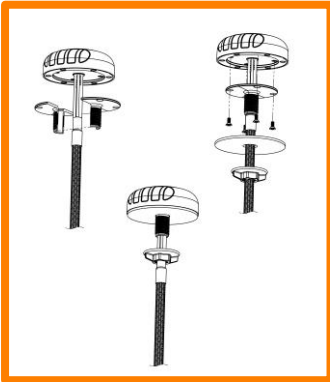

**Spigot Mount**

Removable 35mm & 75mm threaded spigot (included)

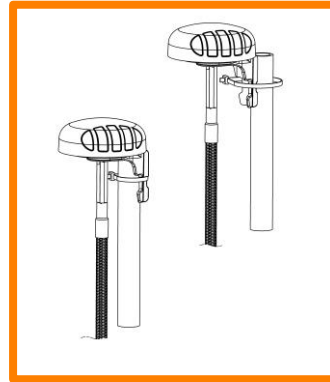

**Vertical Pole Mount**

Pole/Wall Mounting bracket (included)

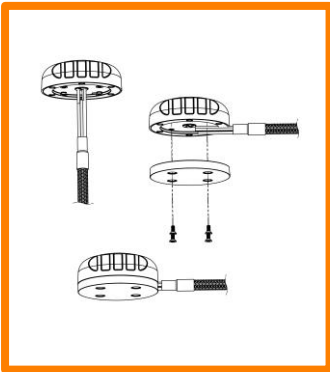

**Magnetic Mount**

Magnetic Base (included)  
For temporary and low mobility installations.

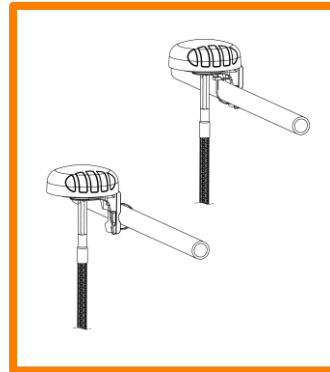

**Horizontal Pole Mount**

Pole/Wall Mounting bracket (included)

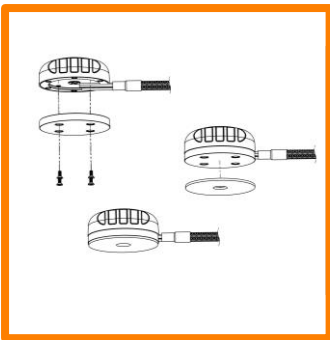

**Surface Mount**

Adhesive Surface Mounting (included) or can also be directly secured with longer M4 bolts (not included) to the female threaded inserts located in the antenna base

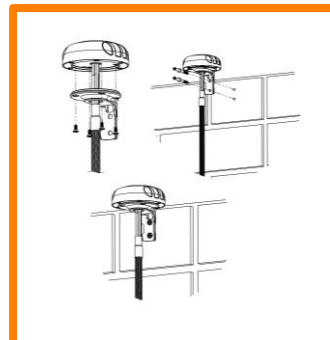

**Wall Mount**

Pole/Wall Mounting bracket (included)

---

## Additional Accessories

See accessories technical specifications on [www.poynting.tech](http://www.poynting.tech)



---

## CONTACT POYNTING

### Poynting Antennas (Pty) Ltd - Head Office

Unit 4, N1 Industrial Park,  
Landmarks Avenue,  
Samrand, 0157, South Africa

**Phone:** +27 (0) 12 657 0050

**E-mail:** [info@poynting.tech](mailto:info@poynting.tech)

**International Email:** [sales-global@poynting.tech](mailto:sales-global@poynting.tech)

### Poynting Europe

Regus Business Center Neue Messe Riem  
Kronstadter Straße 4  
81677 München  
Germany

**Phone:** +49 89 7453 9002

**E-mail:** [sales-europe@poynting.tech](mailto:sales-europe@poynting.tech)

### Poynting USA

1804 Owen Court, Suite 104,  
Mansfield,  
TX 76063  
USA

**Phone:** +1 817 533-8130

**E-mail:** [sales-us@poynting.tech](mailto:sales-us@poynting.tech)