

POYNTING

BEYOND A CONNECTED LIFE

MORAY SERIES



User Guide

Index

1.	Packing Check List	2
2.	Introduction	6
3.	Installation Instructions	8
4.	Antenna Mounting Precautions	9
5.	Cable Routing	9
6.	Safety	10

1. Packing Check List

Item	Description	Quantity
1.	Antenna only	1
2.	Adapter Base	1
3.	Seal	1
4.	L-Bracket	1
5.	Econo bracket stainless steel	2
6.	M6 x 90mm U-Bolts stainless steel	2
7.	M6 Nuts/Nylock nuts stainless steel	4
8.	M6 Flat Washers stainless steel	4
9.	Locking nut	1
10.	M4 Allen Cap Screws	4
11.	Allen key	1
12.	*SMA Grip Extender	2*

**Antenna dependent*

Appearance of components

Antenna Unit*



Adapter Base and Seal

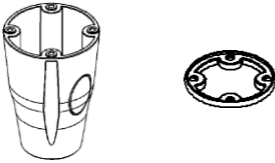

Stainless Steel Bracket Assembly

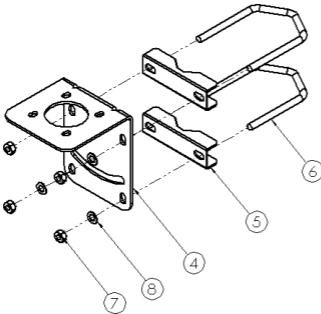

Locking Nut, Allen Cap Screw and Allen Key



SMA Grip Extender



*Antenna appearance and connections may vary depending on model

Optional Accessories

A-BRKT-037: Marine flat mount antenna bracket (stainless steel)

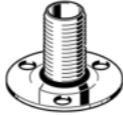

A-BRKT-038: Marine ratchet rail mount antenna bracket (stainless steel)

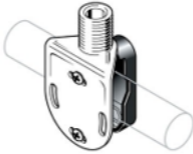

A-BRKT-039: Heavy duty marine mount antenna bracket (stainless steel)

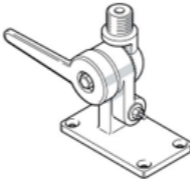

Tools Required

Masonry Drill Bit



Impact Drilling Machine

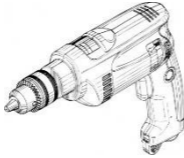

Screwdriver – Cross Slot/Philips



Hammer



Safety Goggles



2. Introduction

This User Guide provides information on the installation instructions of the Omni-directional marine antennas in the MORAY enclosure series.

Antenna Configuration 1

Pole mount with supplied L-Bracket

Attach the L-Bracket to the antenna first using the provided screws and washers before mounting to a pole.

Exploded View

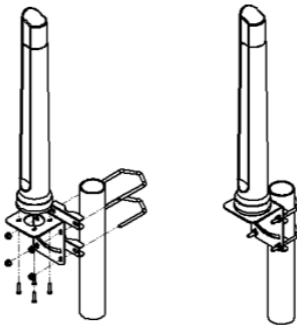

Antenna Configuration 2

Marine mount with optional bracket using the provided allen key

Exploded View

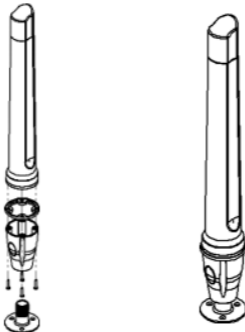

South Africa

Unit 4, N1 Industrial Park
Landmarks Ave
Samrand, 0157
South Africa
Tel: +27 12 657 0050
info@poynting.tech

USA







1804 Owen Court,
Suite 104, Mansfield,
TX 76063
Tel: +1 817 533-8130
sales-us@poynting.tech

Europe

Kronstadler Straße 4,
81677 München
Germany
Tel: +49 89 2080 265 38
Mob.: +49 176 529 733 50
sales-europe@poynting.tech

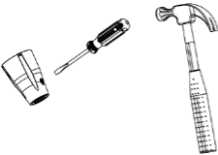
3. Installation Instructions

- Open the antenna package and confirm that all listed components are available.
- Consider the antenna mounting precautions below before installation.

Straight cable entry		
<p>Slide the RF cable through the bracket pipe, seal, and adapter base. Fasten the adapter base to the antenna using the provided allen key.</p>		 <p>Assembled antenna with straight entry cable.</p>
Side cable entry		
 <p>Use a flat screwdriver on the knock out edge of the adapter base to break the knock out section as shown above. A file might be required to remove sharp edges.</p>	 	 <p>Assembled antenna with side entry cable.</p>

4. Antenna Mounting Precautions

- Place the antenna at the highest point of the vessel and ensure that there are no obstructions surrounding the antenna.
- In order to avoid communication interference, ensure that the antenna is placed at least 0.5m away from other antennas and metal objects.
- Avoid installing the antenna near the vessel's chimney, as the smoke and soot emitted by the chimney can obstruct the signal level achieved by the antenna.
- Install the antenna away from the vessel's heat sources and flammable gases.

5. Cable Routing

- Survey the planned cable route and look for any blocked passages. Consider alternate routes to find the best available path. If extension cables are needed, refer to the cable configuration diagram. Always keep the cables as short as possible to make sure that minimum cable losses are achieved.

Note: Take advantage of any existing cable channels e.g., wiring conduits to route the cables.

- Avoid running cables through components or sharp apertures that may cause excessive chafing. Doing so may erode the jacket and break signal continuity. Also, avoid kinking, pinching, or twisting a cable during a run.

When handling the antenna cables, it is essential you follow these basic rules:

- Never pull on the cable connectors; pull only on the cable.
- Never run cables in a manner that interferes with the driver's ability to safely operate the vehicle.
- Tighten the connectors and ensure that the cables don't rattle loose.

6. Safety

- If you are installing an antenna for the first time or unsure about how to install your antenna, obtain the help of a professional installer.
- Carefully survey the installation site before installation to locate secure handholds, dangerous conditions and the safest and most convenient placement for ladders if necessary.
- The antenna may not be used as a climbing or pulling device.
- Considerations must be taken when mounting the antenna that people do not hang or pull on it.
- When installing your antenna, remember:
 1. Do not install on a wet or windy day or when there is lightning or thunder in the area.
 2. Wear shoes with rubber soles and heels, protective clothing (long sleeve shirt or jacket) and rubber gloves.
 3. Avoid installation while under the influence of drugs, alcohol or medication.
 4. Make sure that any loose-fitting jewelry or clothing is secured and tie back long hair as they can get caught in moving parts during installation.

5. If the antenna assembly starts to fall, get away from it and let it fall to avoid harming yourself.
- When drilling remember:
 1. Use safety goggles when drilling the holes.
 2. Avoid using bits that are dull, bent or damaged.
 3. Be aware of where your fingers are in relation to the drill bit when using the drilling machine.
 4. To stop the drilling machine, let the drill chuck come to a complete stop on its own. Do not grasp the chuck in an attempt to stop the drill bit.
 5. Avoid awkward hand positions where a sudden slip could cause a hand to move into the drill bit or cutting tool.

CAUTION:

Antennas must be installed to provide a separation distance of at least 20cm from all persons so as to comply with SAR (Specific Absorption Rate) RF Exposure requirements.



European Waste Electronic Equipment Directive
2002/96/EC

Please ensure that old waste, electricals and electronics are recycled.



Directive 2011/65/EU (RoHS 3)

This product is fully compliant with the RoHS 3 directive.