

WLL TURBINE FLOW METER MANUAL

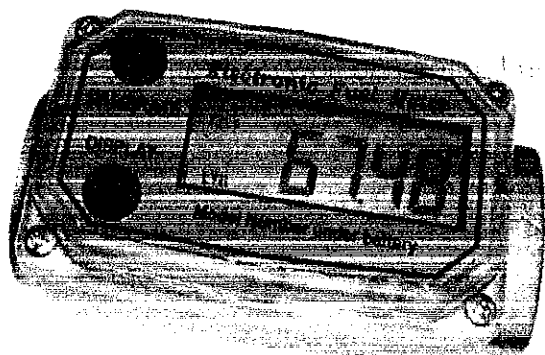

I. Summary

Turbine flow meter control panel adopts Modular design, Computer modules are local shows, it is full-featured and easy-to-use with Simple structure and clear interface.

For this manual, we have introductions about the way for jumper settings and the use of buttons

Please read this manual carefully and operate the control panel accordingly.

II. Features of control panel and wiring

1. Summary

Flow meter adopts low-power CPU core, Turbine sensor signal generated by the amplified pulse is conveyed to the CPU in, CPU operation in accordance with the flow coefficient value will flow to a 5 digits on LCD display, LCD reading range of 0.01 ~ 99999.

In addition to the normal work flow meter flow measurement of liquids, but also can automatically Factory flow coefficient (k) and user manual calibration of the flow coefficient (k) calibration

2. Functions as below

- Two cumulate (which can be reset TTL1 cumulate Clear, TTL2 the total accumulation can not clear zero), it can be shifted by the buttons
- Unit selection: The selection buttons to operate the flow units: liters and gallons (U.S.).
- Sensor pulse frequency range: 5Hz ~ 5000Hz
- Low power consumption: Two pieces of R03(UM-4) 1.5V Common Batteries (can be used for 2 years)
- Factory automatically flow coefficient (k) calibration, the user manual flow coefficient (k) calibration.

3. Performance and technical parameters

- Power supply: Two pieces of R03(UM-4) 1.5V Common Batteries
- Measurement accuracy: 1" $\pm 1\%$; 1 1/2" $\pm 0.5\%$
- Flow range: 1" 18.9~190L/min (5~50GPM)
1 1/2" 38~380L/min (10~100GPM)
- LCD display: shows the current flow value, calibration and fault code code manually when the flow calibration factor (k) value

- Operating temperature range: $-10\text{ }^{\circ}\text{C} \sim +60\text{ }^{\circ}\text{C}$
 - Pressure class: 0.2MPa
4. Jumper definition and connection
- Jumper J2: Choice between normal working status and automatic flow calibration status Factory

III. Functions and operating instructions

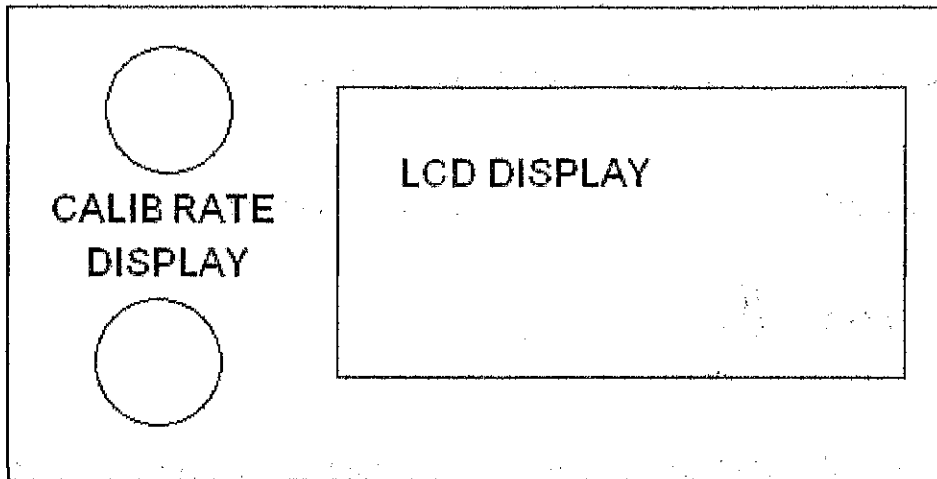

Figure 1

Buttons' operation, LCD display to indicate their location (see Figure 1)

1. Normal work status and operations

A. Buttons' operation

- To press " DISPLAY " shortly can shift current **cumulative**TTL1 and total **cumulative**TTL2, When TTL1 displayed, hold down the "DISPLAY button" about 2 seconds, cumulative flowrate of TTL1 can be cleared "0", while TTL2 can not.
- To press " CALIBRATE " can shift the unit LTR and GAL, and the corresponding characters will be showed on the LCD display
- To press "DISPLAY" and "CALIBRATE" at the same time about 2 seconds will enter the user manual flow coefficient (k) calibration status.

B. LCD Description:

- TTL1: current flow can be cumulative in which can be cleared zero;
- TTL2: current flow displayed is total cumulative in which can not be cleared zero, to clear TTL2 flow for zero, take the batteries from the body and install again.
- LTR: flow unit
- GAL: flow unit (U.S. GAL)
- Figure: five field characters, used to display the flow value of calibration coefficient (k) value and the error symbols

2. Work and dormancy status

When the panel works normally;

- The liquid flows through or to operate the buttons, the control panel LCD shows work status;
- No liquid flows through or to operate the buttons, one minute later the control panel will be in dormancy status, LCD does not display;
- The liquid flows through or to operate the buttons, the control panel LCD will display, the control panel will be waken up and normal working status restored.

3. Calibration work status

Note: only in the unit LTR for calibration

Factory calibration automatically, please follow these steps:

Batteries are not installed on the body, then a short circuit board jumpers J2, after the installation of batteries, it will display **00000**, in which means it has been entered into the calibration status, install the control panel to the shell.

When 100 liters of calibration liquid flows at the control pipeline, the flow value of the flowed liquid will be displayed on LCD screen. The liquid flows out, about 30 seconds, control panel will record the flow value, calculate the flow coefficient (**k**) values and deposited CPU of the permanent preservation of non-volatile memory, even removed the battery discharge coefficient (**k**) will not lose value. If the flow of calibration error over more than the limited 10%, the panel will consider the current calibration value is invalid, and will not record the current calibration value, the screen will show the letters **Err**, and then show the figure **00000**, re-entry into the auto-calibration status.

If the calibration successful, still want to re-calibration, please remove the batteries, repeat the above steps.

Automatic calibration is completed, please remove the battery, then disconnect the circuit board jumper J2, then the battery can be fitted into the normal working status.

User manual calibration by following these steps:

To press "**DISPLAY**" and "**CALIBRATE**" button about 2 seconds at the same time will enter the user manual flow coefficient (**k**) calibration status, such as: $k = 46.33$, at this time LCD display information in Figure 2.

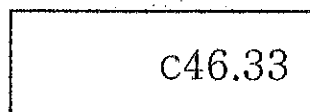

c46.33

Figure 2

Numerical after "c" (such as 46.33) is the modified flow coefficient (**k**) value, the number of flashes that can be modified, and modify the scope: 0 to 9, the position can be shifted by press the "CALIBRATE" button shortly

To press " DISPLAY" shortly can increase the numerical from 0 to 9, increase only , can not reduce.

After modification, press "DISPLAY" and "CALIBRATE" buttons simultaneously, it can return to normal working status.

User manual flow coefficient (**k**) calibration correction formula:

When the user found that the actual traffic flowed liquid flow has a larger error with displayed flow, using the following formula to re-calculated **k** value

$$k = \frac{l \times k_0}{L_0}$$

Note:

- l = flow rate of flow meter
- k_0 = current flow (not to amend before) **k** value
- L_0 = user graduated cylinder measures the value

Users to manually modify the **k** value, for example:

Clear "0" TTL1 value or remove the batteries, to clear TTL1, TTL2 "0", fitted with batteries, button is shifted to TTL1 status, start the measurement of liquid flow, the flowed liquid enters into the standard cylinder. Record the displayed flow value and graduated cylinder flow value after the liquid flows out, such as displayed flow $l=95.56$ LTR, graduated cylinder measures the value $L_0=100$ LTR, current **k** value (not to amend before) $k_0=40$, Calculated as follows

$$k = \frac{95.56 \times 40}{100} = 38.224$$

As it only keeps the 2 numerical after two decimal, $k=38.22$, to modify **k** value to 38.22 is okay

IV. Maintenance

The computerized electronic meters can work at least 9,000 hours (one year) as the battery power. In most cases, the batteries are required to be replaced for one year. Prior to the demolition of the battery on sealed meter will extend batteries life. If the meter readings are dim or blanking, the battery should be replaced. PLS use batteries for Replacement from your distributor or factory.

When the batteries are disconnected or damaged, circuits in batches and the total cumulative return to zero. Factory on-site check at the time still without power at the instrument computer.

I strongly recommend checking the batteries and electrodes cleansing routine should be used as part of the process of maintenance. Battery electrode should be inspected once a year. No need to remove the instrument from the pipeline system, the batteries can be replaced .

V. Batteries replacement

- Remove the four angle screws from the instrument's control panel, take the computerized electronic instruments (LCD screen) from the turbine flow
- Take out the batteries
- Check battery electrode, if rust, and clear it.
- Install new batteries, to ensure that the batteries are installed correctly, after the installation of the batteries, the the computer will be opened automatically, and display the reading information.
- Install the electronic instrument (LCD screen) on the turbine flow meter, ensure that the O-ring is installed to right place. tighten the four screws
- It is prohibited to use isopropyl alcohol to clean the external computer assembly.

VI. Assembly drawing

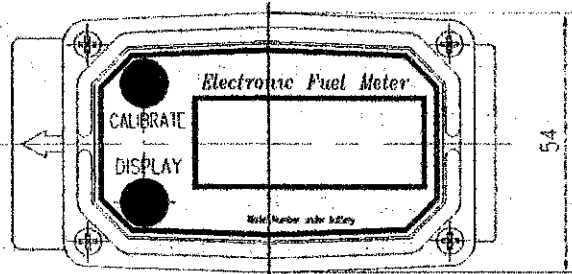
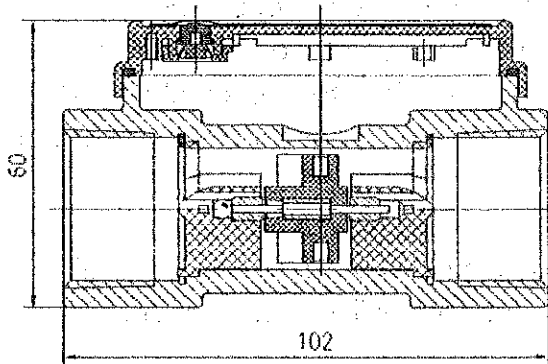

WLL1 Assembly drawing

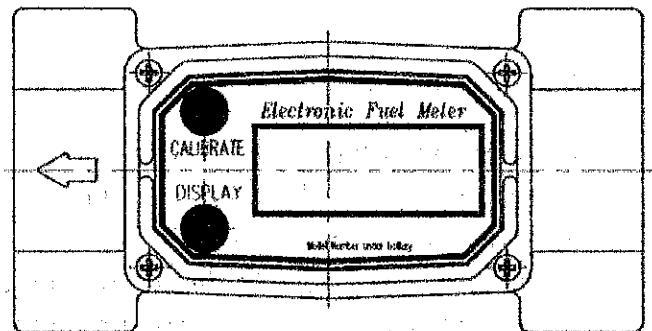
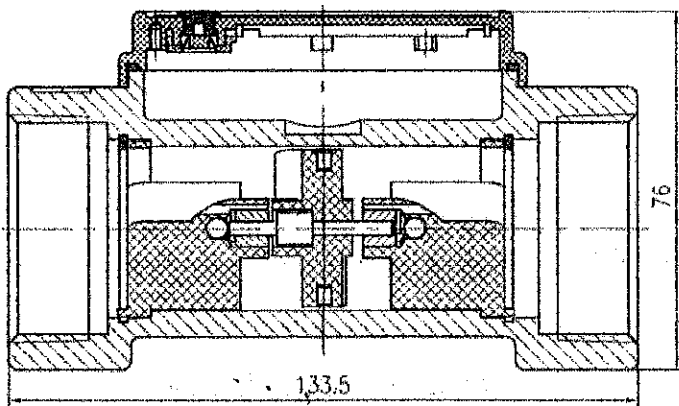

WLL40 Assembly drawing

Mode	Nominal Bore	Connecting Style
WLL1	25mm	NPT1" /BSP1"
WLL40	40mm	NPT1 1/2" /BSP1 1/2"

VII. Fault resolution

FAULTS	REASONS	RESOLUZIONI
Data inaccurate	<ol style="list-style-type: none"> 1. On-site calibration method is not correct. 2. Factory calibration is not suitable for liquid under measurement. 3. Instrument operation is less than the minimum flow rate. 4. The flow meter is blocked by part of dry liquid. 5. Sealant material wrapped around the impeller. 6. Packed with accessories too closely. 7. Installed too close to the motor or electronic noise environment. 	<ol style="list-style-type: none"> 1. Re-calibration on-site or scene selection for Factory calibration. 2. Calibration on-site by Check Chapter 3. Remove the impeller and carefully cleaned. To ensure that the impeller rotating freely. 4. Removed instrument (LCD screen) to ensure that the impeller rotating freely. 5. Installed correctly. 6. Installed correctly.
Readings are degenerating or blanking	<ol style="list-style-type: none"> 1, Power of batteries is weak, or even on depleted. 2, The computer failure. 	<ol style="list-style-type: none"> 1. Removed the computer and, if necessary, check and reinstall or replace the batteries. 2. Factory contact.
Normal flow rate but the instrument does not count, when pressing the DISPLAY button, the instrument boots.	<ol style="list-style-type: none"> 1, On-site calibration method is not correct. 2, Impeller jammed or damaged. 3, Sealant material wrapped around the impeller. 4, The computer failure. 	<p>Re-check on-site, or check by Factory.</p> <p>Removed instrument to ensure that the impeller rotating freely.</p> <p>Removed instrumentation to ensure that the impeller rotating freely.</p> <p>Contact factory</p>
The flow rate meter reduced and can not counter, when press "DISPLAY", instrument boots.	<ol style="list-style-type: none"> 1, The flow meter is blocked by dry liquid. 2, Lower than minimum flow rate 	<p>Removed instrument (LCD screen) to ensure that the impeller rotating freely.</p> <p>Improve flow rate.</p>
Instrument is not allowed the access to the site check.	<ol style="list-style-type: none"> 1, The computer circuit board failure. 2, Buttons failure. 	<p>Replace the computer, contact factory</p> <p>Replace the computer, contact factory</p>