

 Unità carrellata da 1,5 HP per l'aspirazione e la filtrazione di fumi di saldatura in impieghi poco gravosi. Agile, maneggevole e performante, ECOMINOR è equipaggiato con una batteria di 4 filtri in sequenza per filtrare meccanicamente e deodorare il fumo aspirato. Braccio autoportante articolato da 3 mt incluso. Portata max di 1.400 m³/h. Idoneo per impieghi poco gravosi.

 A 1.5 HP, trolley mounted unit for extracting and filtering fumes produced in light welding applications. ECOMINOR is agile, manageable and offers high performance, it is supplied with a battery of 4 mechanical filters in sequence that filter and deodorise the fumes. A 3 m self-supporting articulated arm is included. Max capacity 1.400 m³/h. Light process.

 Unité mobile de 1,5 HP pour l'aspiration et la filtration de fumées de soudure lors d'utilisations légères. Agile, maniable et puissant, ECOMINOR est équipé d'une batterie de 4 filtres successifs pour le filtrage mécanique et la désodorisation de la fumée aspirée. Equipé avec bras articulé autoportant de 3 m. Débit max de 1.400 m³/h. Emplois peu lourdes.

 Fahrbare 1,5 PS Einheit für das Absaugen und Filtern von Schweißrauch für den leichteren Einsatz. ECOMINOR ist handlich, beweglich und leistungsstark und mit einer Batterie von 4 Reihenfiltern für die mechanische Filterung und Geruchsverbesserung des angesaugten Rauchs ausgestattet. Geliefert mit einen selbsttragenden Gelenkarm 3 m Lang. Max. Förderleistung 1.400 m³/h. Wenig schweren Arbeiten.

 Unidad móvil de 1,5 HP para aspirar y filtrar humos de soldadura en condiciones de empleo ligero. Ágil, manejable y funcional, ECOMINOR está equipada con una batería de 4 filtros en secuencia para filtrar mecánicamente y desodorizar el humo aspirado. Equipado con brazo articulado de 3 m. Caudal máx. 1.400 m³/h. Empleos ligeros.

OPTIONAL

ARMFLEX420/C

BRACCIO ARTICOLATO AUTOPORTANTE L.4,0 mt Ø160mm

Cappetta standard in plastica

SELF SUPPORTING ARTICULATED ARM L.4,0 mt Ø160mm

Standard plastic cap

BRAS ARTICULÉ AUTOPORTEUR L.4,0 mt Ø160mm

Bouchon en plastique standard

SELBSTSTÄNDIGER GELENKARM L.4,0 mt Ø160mm

Standard-Kunststoffkappe

BRAZO ARTICULADO AUTOPORTANTE L.4,0 mt Ø160mm

Tapa de plástico estandare



Light

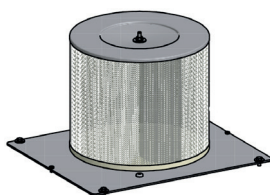
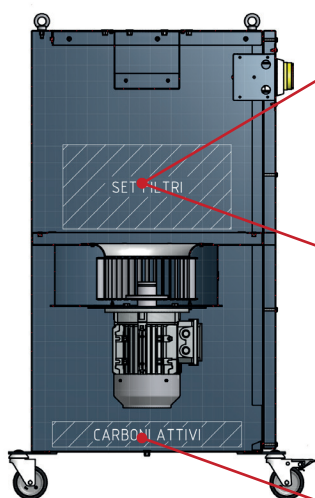

ECOMINOR-NG/CART : CELLULOSE Ø350 - H300 - EN 60335-2-69 - Class M

ECOMINOR-NG/CART-P : POLYESTER Ø350 - H300 - EN 60335-2-69 - Class M

ECOMINOR-NG/CART-HEPA : POLYESTER HEPA Ø350 - H300 - EN 1822 - Class H13

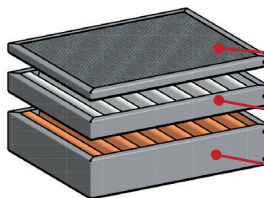

ECOMINOR-NG/RIPM : PREFILTRO METALLICO / METAL PREFILTER

ECOMINOR-NG/RIPS : PREFILTRO SINTETICO / PREFILTER

ECOMINOR-NG/RIF : FILTRO ALTA EFFICIENZA / HIGH EFFICIENCY FILTER

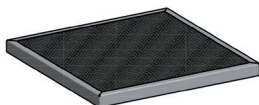

ECOMINOR-NG/CONT4.5 : FILTRO A CARBONI ATTIVI / CARBON FILTER 4,5 Kg

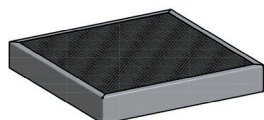

ECOMINOR-NG/CONT10 : FILTRO A CARBONI ATTIVI / CARBON FILTER 10 Kg

ECOMINOR-NG-FLEX

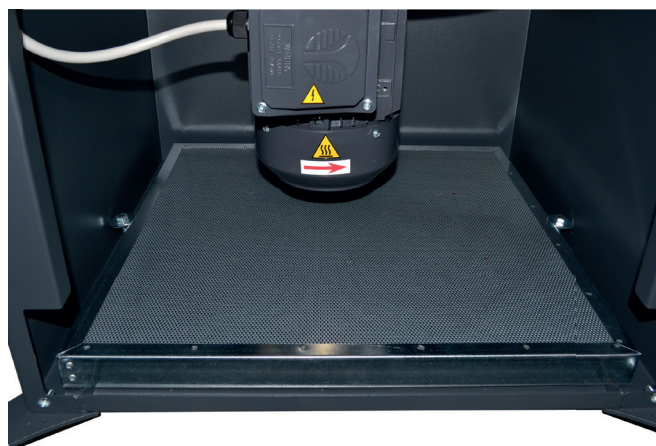

Dettagli tecnici - Technical details - Données techniques - Technische Daten - Datos Técnicos

Model		%	m ²		Carb. Kg	Carb. Lbs		cert	
ECOMINOR-NG-FLEX	1400 m ³ /h 823 c.f.m.	95	1,2	94 kg 207 lb	4,5	9,9	400 V - 52 Hz - 3ph (3p+T)	CE	1,5 Hp 1,1kW
ECOMINOR-NG-FLEX-CARB	1400 m ³ /h 823 c.f.m.	90	0,3	99 kg 218 lb	10	22	400 V - 52 Hz - 3ph (3p+T)	CE	1,5 Hp 1,1kW
ECOMINOR-NG-FLEX-C	1600 m ³ /h 882 c.f.m.	99,95	6	94 kg 207 lb	-	-	400 V - 52 Hz - 3ph (3p+T)	CE	1,5 Hp 1,1kW
ECOMINOR-NG-FLEX-C-4.5CA	1600 m ³ /h 882 c.f.m.	99,95	6	99 kg 218 lb	4,5	9,9	400 V - 52 Hz - 3ph (3p+T)	CE	1,5 Hp 1,1kW
ECOMINOR-NG-FLEX-C-10CA	1600 m ³ /h 882 c.f.m.	99,95	6	104 kg 229 lb	10	22	400 V - 52 Hz - 3ph (3p+T)	CE	1,5 Hp 1,1kW
ECOMINOR-NG-FLEX-C/P	1600 m ³ /h 882 c.f.m.	99,95	6	94 kg 207 lb	-	-	400 V - 52 Hz - 3ph (3p+T)	CE	1,5 Hp 1,1kW
ECOMINOR-NG-FLEX-C/P-4.5CA	1600 m ³ /h 882 c.f.m.	99,95	6	99 kg 218 lb	4,5	9,9	400 V - 52 Hz - 3ph (3p+T)	CE	1,5 Hp 1,1kW
ECOMINOR-NG-FLEX-C/P-10CA	1600 m ³ /h 882 c.f.m.	99,95	6	104 kg 229 lb	10	22	400 V - 52 Hz - 3ph (3p+T)	CE	1,5 Hp 1,1kW
ECOMINOR-NG-FLEX-HEPA	1400 m ³ /h 823 c.f.m	99,95	6	94 kg 207 lb	-	-	400 V - 52 Hz - 3ph (3p+T)	CE	1,5 Hp 1,1kW
ECOMINOR-NG-FLEX-HEPA-4.5CA	1400 m ³ /h 823 c.f.m	99,95	6	99 kg 218 lb	4,5	9,9	400 V - 52 Hz - 3ph (3p+T)	CE	1,5 Hp 1,1kW
ECOMINOR-NG-FLEX-HEPA-10CA	1400 m ³ /h 823 c.f.m	99,95	6	104 kg 229 lb	10	22	400 V - 52 Hz - 3ph (3p+T)	CE	1,5 Hp 1,1kW

Tabella filtri - Filter table - Tableau des filtres - Tabelle filtern - Tabla de filtros

MODELLO	BRACCIO	FILTRI						CARBONI ATTIVI	
		FILTRI A PANNELLO			CARTUCCE			ECOMINOR- NG/CONT4.5	ECOMINOR- NG/CON10
		ECOMINOR- NG/RIPM	ECOMINOR- NG/RIPS	ECOMINOR- NG/RIF	ECOMINOR- NG/CART	ECOMINOR- NG/CART-P	ECOMINOR- NG/CART-HEPA		
ECOMINOR-NG	TECHNO3/C	✓	✓	✓	✗	✗	✗	✓	✗
ECOMINOR-NG-CARB	TECHNO3/C	✓	✓ (x2)	✗	✗	✗	✗	✗	✓
ECOMINOR-NG-C	TECHNO3/C	✗	✗	✗	✓	✗	✗	✗	✗
ECOMINOR-NG-C-4.5CA	TECHNO3/C	✗	✗	✗	✓	✗	✗	✓	✗
ECOMINOR-NG-C-10CA	TECHNO3/C	✗	✗	✗	✓	✗	✗	✗	✓
ECOMINOR-NG-C/P	TECHNO3/C	✗	✗	✗	✗	✓	✗	✗	✗
ECOMINOR-NG-C/P-4.5CA	TECHNO3/C	✗	✗	✗	✗	✓	✗	✓	✗
ECOMINOR-NG-C/P-10CA	TECHNO3/C	✗	✗	✗	✗	✓	✗	✗	✓
ECOMINOR-NG-HEPA	TECHNO3/C	✗	✗	✗	✗	✗	✓	✗	✗
ECOMINOR-NG-HEPA-4.5CA	TECHNO3/C	✗	✗	✗	✗	✗	✓	✓	✗
ECOMINOR-NG-HEPA-10CA	TECHNO3/C	✗	✗	✗	✗	✗	✓	✗	✓
ECOMINOR-NG-FLEX	ARMFLEX	✓	✓	✓	✗	✗	✗	✓	✗
ECOMINOR-NG-FLEX-CARB	ARMFLEX	✓	✓ (x2)	✗	✗	✗	✗	✗	✓
ECOMINOR-NG-FLEX-C	ARMFLEX	✗	✗	✗	✓	✗	✗	✗	✗
ECOMINOR-NG-FLEX-C-4.5CA	ARMFLEX	✗	✗	✗	✓	✗	✗	✓	✗
ECOMINOR-NG-FLEX-C-10CA	ARMFLEX	✗	✗	✗	✓	✗	✗	✗	✓
ECOMINOR-NG-FLEX-C/P	ARMFLEX	✗	✗	✗	✗	✓	✗	✗	✗
ECOMINOR-NG-FLEX-C/P-4.5CA	ARMFLEX	✗	✗	✗	✗	✓	✗	✓	✗
ECOMINOR-NG-FLEX-C/P-10CA	ARMFLEX	✗	✗	✗	✗	✓	✗	✗	✓
ECOMINOR-NG-FLEX-HEPA	ARMFLEX	✗	✗	✗	✗	✗	✓	✗	✗
ECOMINOR-NG-FLEX-HEPA-4.5CA	ARMFLEX	✗	✗	✗	✗	✗	✓	✓	✗
ECOMINOR-NG-FLEX-HEPA-10CA	ARMFLEX	✗	✗	✗	✗	✗	✓	✗	✓

Dimensioni - Dimensions - Dimensions - Abmessungen - Dimensiones

