

# Instruction Manual

\_\_\_\_\_ Manual sheet metal shear

\_\_\_\_\_ TBS 1501-15

\_\_\_\_\_ TBS 2001-12



TBS 1501-15

TBS-SERIES

## Imprint

### Product identification

Manual sheet metal shears	Item number
TBS 1501-15	3746015
TBS 2001-12	3746020

### Manufacturer

Stuermer Maschinen GmbH  
Dr.-Robert-Pfleger-Str. 26  
D-96103 Hallstadt

Fax: 0049 (0) 951 96555 - 55

E-Mail: info@metalkraft.de  
Internet: www.metalkraft.de

### Information on the operating instructions

Original instructions

Edition: 20.11.2019  
Version: 1.03  
Language: English  
Author: SN/FL

### Copyright information

Copyright © 2019 Stuermer Maschinen GmbH, Hallstadt, Germany.

The contents of this manual are the sole property of Stuermer Maschinen GmbH.  
Unauthorized copying and distribution of this document, as well as the use and communication of its content are strictly prohibited unless expressly permitted. Infringements require compensation.

Technical changes and errors reserved.

## Contents

<b>1 Introduction .....</b>	<b>3</b>
1.1 Copyright .....	3
1.2 Customer Service .....	3
1.3 Limitation of Liability .....	3
<b>2 Safety .....</b>	<b>3</b>
2.1 Symbol Explanation .....	3
2.2 Responsibility of the operator .....	4
2.3 Qualification of personnel .....	4
2.4 Personal protective equipment .....	5
2.5 Safety markings on the machine .....	5
<b>3 Intended Use.....</b>	<b>5</b>
3.1 Predictable misuse .....	6
3.2 Residual risks .....	6
<b>4 Technical Data.....</b>	<b>6</b>
4.1 Type plate .....	6
<b>5 Transport, Packaging, Storage .....</b>	<b>6</b>
5.1 Delivery and Transport .....	6
5.2 Packaging .....	7
5.3 Storage .....	7
<b>6 Description .....</b>	<b>7</b>
6.1 Scope of delivery .....	7
6.2 Accessories - not included .....	8
<b>7 Assembly and adjustments.....</b>	<b>8</b>
7.1 Set up .....	8
7.2 Settings.....	8
<b>8 Operation .....</b>	<b>10</b>
<b>9 Care and Maintenance .....</b>	<b>10</b>
9.1 Care by cleaning.....	10
9.2 Lubrication schedule.....	10
<b>10 Troubleshooting .....</b>	<b>11</b>
<b>11 Disposal, recycling of old equipment... 11</b>	<b>11</b>
11.1 Decommission .....	11
11.2 Disposal of lubricants.....	11
<b>12 Spare parts .....</b>	<b>12</b>
12.1 Ordering spare parts.....	12
12.2 Spare parts drawing.....	13
<b>13 Declaration.....</b>	<b>14</b>
<b>14 Notes .....</b>	<b>15</b>

## 1 Introduction

You have made a good choice by purchasing the Manual sheet metal shears made by METALLKRAFT.

### Thoroughly read the operating instructions before commissioning the machine.

It informs you about the proper commissioning, the intended use as well as the safe and efficient operation and maintenance of your machine.

The operating instructions are part of the machine. Always keep it at the place of use of the machine. Furthermore, the local accident prevention regulations and the general safety notes are applicable for the field of application of the machine.

The illustrations in these operating instructions serve the general comprehension and may deviate from the actual type.

### 1.1 Copyright

The contents of these instructions are copyright. Their application is admissible in the frame of the machine utilisation. An application beyond the described application is not allowed without written approval of the manufacturer. For the protection of our products, we shall register trademark, patent and design rights, as this is possible in individual cases. We strongly oppose any infringement of our intellectual property.

### 1.2 Customer Service

Please contact your dealer if you have any questions about your Manual sheet metal shears or for technical information. There you will be happy to help with expert advice and information.

#### Germany:

Stürmer Maschinen GmbH  
Dr.-Robert-Pfleger-Str. 26  
D-96103 Hallstadt

#### Repair-Service:

Fax: 0049 (0) 951 96555-111  
E-Mail: [service@stuermer-maschinen.de](mailto:service@stuermer-maschinen.de)  
Internet: [www.metalkraft.de](http://www.metalkraft.de)

#### Spare part orders:

Fax: 0049 (0) 951 96555-119  
E-Mail: [ersatzteile@stuermer-maschinen.de](mailto:ersatzteile@stuermer-maschinen.de)

We are always interested in valuable experience and knowledge gained from using the application, which-then could be shared and be valuable to develop our products even further.

## 1.3 Limitation of Liability

All information and notes in these operating instructions were summarised taking the applicable standards and rules, the state-of-the-art and our long-term knowledge and experiences into consideration.

In the following cases the manufacturer is not liable for damages:

- Non-observance of the operating instructions,
- Inappropriate use,
- Use of untrained staff,
- Unauthorised modifications,
- Technical changes,
- Use of not allowed spare parts.

The actual scope of delivery may deviate from the explanations and presentations described here in case of special models, when using additional ordering options or due to latest technical modifications.

The obligations agreed in the delivery contract, the general terms and conditions as well as the delivery conditions of the manufacturer and the legal regulations at the time of the conclusion of the contract are applicable.

## 2 Safety

This paragraph will give you an overview of all important safety packages for the protection of the people using it well as for a safe and undisturbed operation. Other task-based safety notes are included in the individual chapters.

### 2.1 Symbol Explanation

#### Safety Instructions

The safety notes in these operating instructions are highlighted by symbols. The safety notes are introduced by signal words which express the concern of the risk.



#### DANGER!

This combination of symbol and signal words indicates an imminently dangerous situation which may lead to death or severe injuries if they are not avoided.



#### WARNING!

This combination of symbol and signal words indicates a possibly dangerous situation which may lead to minor or light injuries if they are not avoided.



**CAUTION!**

This combination of symbol and signal word indicates a potentially hazardous situation which, if not avoided, could result in minor injury.



**ATTENTION!**

This combination of symbol and signal word indicates a potentially hazardous situation which, if not avoided, could result in property damage and environmental damage.



**NOTE!**

This combination of symbol and signal words indicates a possibly dangerous situation which may lead to property and environmental damages if they are not avoided.

**Tips and recommendations**



**Tips and recommendations**

This symbol highlights useful tips and recommendations as well as information for an efficient and trouble-free operation.

It is necessary to observe the safety notes quoted in these operating instructions in order to reduce the risks for personal injuries and damages to property.

**2.2 Responsibility of the operator**

The operator is the person who operates the machine for commercial or economic purposes himself or leaves it to a third party for use or application and bears the legal product responsibility for the protection of the user, the personnel or third parties during operation.

**Operator obligations:**

If the machine is used in the commercial sector, the operator of the machine is subject to the legal obligations for occupational safety. Therefore, the safety instructions in this operating manual as well as the safety, accident prevention and environmental protection regulations valid for the area of application of the machine must be observed. The following applies in particular:

- The operator must inform himself about the applicable occupational health and safety regulations and, in a risk assessment, determine additional hazards that result from the special working conditions at the place of use of the machine. He must implement these in the form of operating instructions for the operation of the machine.

- The operator must check during the entire period of use of the machine whether the operating instructions he has prepared comply with the current state of the regulations and adjust them if necessary.
- The operator must clearly regulate and determine the responsibilities for installation, operation, troubleshooting, maintenance and cleaning.
- The operator must ensure that all persons handling the machine have read and understood this manual. In addition, he must train the staff at regular intervals and inform them about the dangers.
- The operator must provide the personnel with the necessary protective equipment and bind the wearing of necessary protective equipment.

Furthermore, the operator is responsible for ensuring that the machine is always in perfect technical condition. Therefore, the following applies:

- The operator must ensure that the maintenance intervals described in this manual are observed.
- The operator must have all safety equipment regularly checked for functionality and completeness.

**2.3 Qualification of personnel**

The different tasks described in this manual represent different requirements to the qualification of the persons entrusted with these tasks.



**WARNING!**

**Danger in case of insufficient qualification of the staff!**

Insufficiently qualified persons cannot estimate the risks while using the machine and expose themselves and others to the danger of severe injuries.

- Have all works only performed by qualified persons.
- Keep insufficiently qualified persons and children out of the working area.

Only persons reliable working procedures can be expected from, are allowed to perform all works. Persons the responsiveness of which is affected by e. g. drugs, alcohol or medication, are not allowed to work with the machine.

The qualifications of the personnel for the different tasks are mentioned below:

**Operator:**

The operator is instructed by the operating company about the assigned tasks and possible risks in case of improper behaviour. Any tasks which need to be performed beyond the operation in the standard mode must only be performed by the operator if it is indicated in these instructions and if the operating company expressly commissioned the operator.

**Electrician:**

Due to their professional training, knowledge and experience as well as knowledge of the relevant standards and regulations, the electrician is in a position to carry out work on electrical installations and to recognize and avoid possible dangers independently.

**Specialist staff:**

Due to their professional training, knowledge and experience as well as their knowledge of relevant regulations the specialist staff is able to perform the assigned tasks and to recognise and avoid any possible dangers themselves.

**Manufacturer:**

Certain works may only be performed by specialist personnel of the manufacturer. Other personnel is not authorized to perform these works. Please contact our customer service for the execution of all arising work.

**2.4 Personal protective equipment**

The personal protective equipment serves to protect persons against impairments of safety and health while working. The staff has to wear personal protective equipment while performing different works on and with the appliance which are indicated in the individual paragraphs of these instructions.

The personal protective equipment is explained in the following paragraph:



**Head protection**  
The industrial helmet protects the head from falling objects and bumping against fixed objects.



**Ear protection**  
Hearing protection protects ears from hearing damage caused by noise.



**Eye protection**  
The goggles protect the eyes from flying parts and liquid splashes.



**Protective gloves**  
The protective gloves serve to protect the hands against sharp components as well as against friction, abrasions or deep injuries.



**Safety boots**  
The safety boots protect the feet against crushes, falling parts and slipping over on slippery underground.



**Protective clothes**  
The protective clothes are tight clothes of little tensile strength.

**2.5 Safety markings on the machine**

There are various warning signs and safety markings on the sheet metal shears (Fig. 1), which must be observed and followed.



Fig. 1: Safety signs

The safety markings attached to the sheet metal shears must not be removed. Damaged or missing safety markings can lead to malfunctions, personal injury and property damage. They are to be replaced immediately. If the safety markings are not immediately recognizable and comprehensible, the sheet metal shears should be taken out of service until new safety markings have been made.

**3 Intended Use**

The sheet metal shears are used exclusively for cutting mild steel, aluminum, copper, zinc and plastics. It may only be operated by instructed persons familiar with the device. Proper use also includes compliance with all information in this manual. Any use beyond the intended use or otherwise is considered misuse.



**WARNING!**

**Danger in case of misuse!**

Misuse of the sheet metal scissors can lead to dangerous situations.

- Only operate the sheet metal shears in the performance range specified in the technical data.
- Never bypass or override the safety devices.
- Only operate the sheet metal shears in a technically perfect condition.

Unauthorized modifications or changes to the sheet metal scissors can invalidate the CE conformity of the sheet metal scissors and are prohibited. The company Stürmer Maschinen GmbH assumes no liability for design and technical changes to the sheet metal scissors.

The improper use of the sheet metal shears as well as the disregard of the safety regulations or the operating instructions exclude a liability of the manufacturer for resulting damage to persons or objects and cause the warranty to lapse!

**3.1 Predictable misuse**

When using the sheet metal shears, no reasonably foreseeable misuse is possible if the intended use is observed, which could lead to dangerous situations involving personal injury.

**3.2 Residual risks**

Even if all safety regulations are adhered to, a residual risk described below remains with the operation of the sheet metal shears. All persons working with the sheet metal scissors must be aware of these residual risks and follow the instructions that prevent these residual risks leading to accidents or damage.

- There is a risk of injury to the upper limbs (e.g., hands, fingers).
- Danger from falling workpieces.
- During set-up and set-up work, it may be necessary to dismantle on-site protective equipment. This creates various residual risks and potential dangers that every operator must be aware of.

**4 Technical Data**

Model	TBS 1501-15	TBS 2001-12
Length [mm]	1950	2450
Width [mm]	1100	1100
Height [mm]	1050	1050
Weight [kg]	455	511
Table height (mm)	684	684
Max. working width max [mm]	1500	2000
Sheet thickness (400 N/mm <sup>2</sup> ) max.	1,5	1,25
Sheet thickness (700 N/mm <sup>2</sup> ) max.	0,75	0,62
Rear stop adjustment range up to [mm]	0-300	0-300

**4.1 Type plate**

**Manuelle Tafelblechschere**  
Sheet metal shear CE

<b>Typ</b> Type	<b>TBS 1501-15</b>	<b>Serien-Nr.</b> Serial no.	
<b>Artikel-Nr.</b> Item no.	<b>3746015</b>	<b>Baujahr</b> Year of manufacture	
<b>Gewicht</b> Weight	<b>445 kg</b>	<b>Max. Schnittlänge</b> Max. cutting width	<b>1500 mm</b>
<b>Max. Schnittleistung bei 400 N/mm<sup>2</sup></b> Max. cutting performance at 400 N / mm <sup>2</sup>	<b>1,5 mm</b>		
<b>Max. Schnittleistung bei 700 N/mm<sup>2</sup></b> Max. cutting performance at 700 N / mm <sup>2</sup>	<b>0,75 mm</b>		

Stürmer Maschinen GmbH  
 Dr.-Robert-Pfleger-Str. 26, 96103 Hallstadt  
 Deutschland / Germany  
[www.metalkraft.de](http://www.metalkraft.de)

Fig. 2: Type plate

**5 Transport, Packaging, Storage**

**5.1 Delivery and Transport**

**Delivery**

After delivery, inspect the sheet metal shears for visible transport damage. If the sheet metal shears show damage, they must be reported immediately to the transport company or the dealer.



## Transport



### WARNING!

#### Risk of death!

If the weight of the machine and the permissible lifting capacity of the lifting gear are not observed during transport or lifting, the machine may tip over or fall.

- During transport and lifting work, pay attention to the weight of the machine. The means of transport and lifting equipment must be able to take up the load.
- The transport may only be carried out by specialists.



### NOTE!

Protect the sheet metal shears from moisture.

### Transport with a forklift / pallet truck:

The unit is delivered on a pallet so that it can be transported with a forklift or pallet truck.

### Transport by crane:

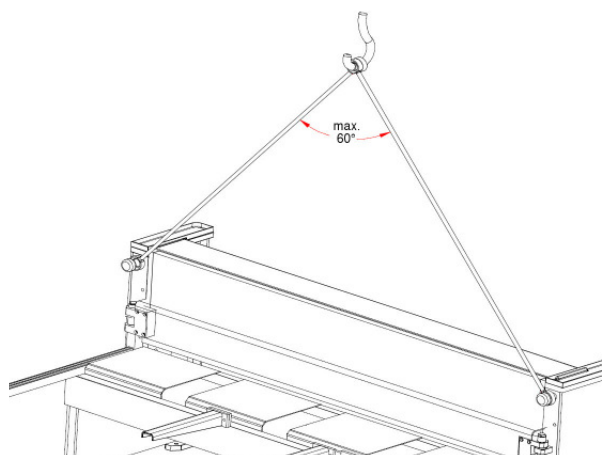

Fig. 3: Stop of ropes for transport by crane

Transport only with steel cables and hooks designed to weigh at least 1 tonne. The attachment points for the transport must be used on the sheet metal shears (Fig. 3).

## 5.2 Packaging

All used packaging materials and packaging aids of the appliance are recyclable and generally need to be transported to the material recycling.

Crush the packaging material made of cardboard and supply it to the waste paper collection.

The films are made of polyethylene (PE) and the upholstery parts are made of polystyrene (PS). These materials have to be delivered to a recycling station of the responsible dumping company.

## 5.3 Storage

Thoroughly clean the sheet metal shears in a dry, clean and frost-free environment.

## 6 Description

Illustrations in this operating manual serve the general understanding and may deviate from the actual design.

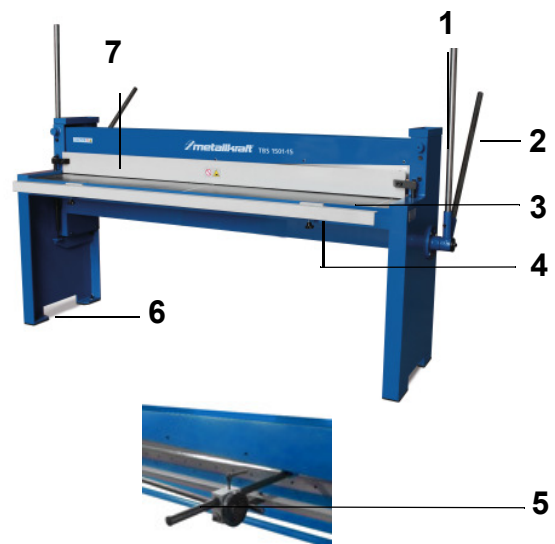

Fig. 4: Description TBS 1501-15

- 1 Transport lifting point
- 2 Hand lever
- 3 Work table
- 4 Material support, extendable
- 5 Adjustable backgauge
- 6 Hole for anchoring
- 7 Hold downs

## 6.1 Scope of delivery

- Rear stop
- Two control handles
- Instruction manual

## 6.2 Accessories - not included

TBS 1501-15:

- Replacement knife set TBS 1501-15
- Special knife set for cutting stain-less steel TBS 1501-15

TBS 2001-12:

- Replacement knife set TBS 2001-12
- Special knife set for cutting stain-less steel TBS 2001-12

## 7 Assembly and adjustments

### 7.1 Set up



**Use protective gloves!**



**Use protective boots!**



**Wear protective clothes!**



**ATTENTION!**

**Risk of crushing!**

Incorrect work on the motorized sheet metal scissors is a risk of injury to the upper limbs.

In order to achieve good functionality and long life of the sheet metal shears, the site should meet the following criteria:

- The substrate must be level, firm and vibration-free.
- The installation or working room must be dry and well ventilated.
- Do not operate machines that cause dust and chips nearby.
- There must be sufficient space for the operating personnel, for material transport as well as for adjustment and maintenance work.
- The site must have good lighting.

The sheet metal shears are already preassembled in the delivery state with the exception of some add-on parts.



**NOTE!**

After setting up, remove the protective agent from the bare metal parts, which have been applied to protect against rusting..

- Use usual solvents.
- No water, no nitrolic solvents or similar use!

Step 1: Insert the hand lever (2, Fig. 4) into the holder and screw tight. The shorter hand levers must be mounted on the operator side.

Step 2: Insert the racks of the backgauge (Fig. 5) into the recesses on the crossbeam on the back, tighten and align with the zero point.

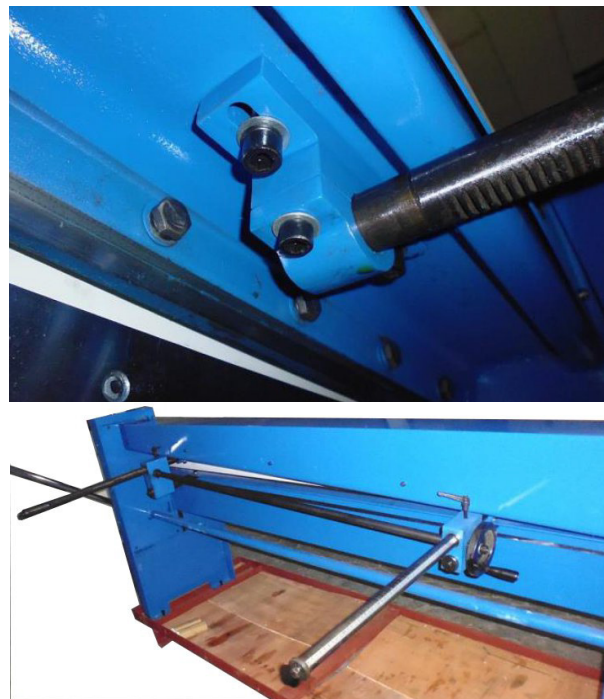

Fig. 5: Assembly of the backgauge

### 7.2 Settings

#### Cutting gap

Step 1: Unscrew the tool holders and the covers of the knife guides.

Step 2: Loosen the nuts (32, Fig. 12) and screws (33) on the front and lower the upper knife on the right side to a position 5 - 6 mm lower than the left side.

Step 3: Tighten the screws (33) on the rear one after the other until the cutting gap between the upper blade and the lower blade is set to the desired value.





Fig. 6: Adjust cutting gap, nuts for position of the upper knife on the front

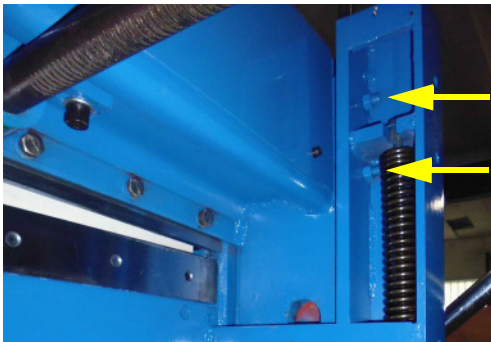

Fig. 7: Adjust cutting gap, screws for position of the upper knife on the back

- Step 4: Tighten the nuts (32) on the back. Then tighten the nuts (32) and the screws (33) on the front.
- Step 5: Perform a test cut to see if the kerf is well set for high quality cuts.
- Step 6: Screw on the tool trays and the covers of the knife guides.

**Lower stop for upper knife**

- Step 1: Use the hand lever to lower the upper knife until the left end of the upper knife overlaps the lower knife by approx. 2-3 mm.
- Step 2: Loosen the nuts (81) and bring the stop into contact with the cam (36). Then tighten the nuts (81).



Fig. 8: Lower stop for upper knife

**Adjust the hold down**

In order to ensure a uniform fixation of the workpiece during cutting, the hold-down can be adjusted.

- Step 1: Loosen the nuts (9) on the underside of the machine and adjust the position of the blank holder with the adjusting screws (8). Then tighten the nuts (9).
- Step 2: Check whether there is a uniform fixation of the workpiece. If necessary, readjust the position of the hold-down.



Fig. 9: Workpiece hold-down (left), adjusting screw (right)

**Behind-stop**

In order to be able to process several workpieces with the same dimensions, the stop on the back of the device can be set to the desired dimension.



Fig. 10: Adjust rear stop: Clamping screw, handwheel and scale

- Step 1: Loosen the clamping screws on both sides of the stopper.
- Step 2: Move the stop to the desired position with the handwheel. The position value can be read on the scale.
- Step 3: Tighten the clamping screws on both sides of the stopper.

## 8 Operation



### WARNING!

#### Danger due to insufficient qualification of persons!

Insufficiently qualified persons can not assess the risks involved in handling sheet metal shears and expose themselves and others to the risk of serious or fatal injuries.

- All work should only be carried out by qualified persons.
- Keep inadequately qualified persons out of the work area.



### ATTENTION!

#### Risk of crushing!

Incorrect work on the sheet metal scissors is a risk of injury to the upper limbs.



### DANGER!

The following rules must be followed.

- Never work on the sheet metal scissors under the influence of alcohol, drugs or medication and / or in case of fatigue or concentration-impairing illnesses.
- The sheet metal shears may only be operated by a trained person.



#### Use protective gloves!



#### Use protective boots!



#### Wear protective clothes!

Step 1: Place the sheet to be cut on the machine table, bring the scale into the correct position and adjust the material stops to the desired size.

Step 2: Press the sheet against the material stops and fix it with the hold-down by moving the hand lever downwards a little.

Step 3: Move the hand lever completely down to make the cut.

## 9 Care and Maintenance



### Tips and recommendations

To ensure that the sheet metal shears are always in good operating condition, regular care and maintenance work must be carried out.



### WARNING!

#### Danger due to insufficient qualification of persons!

Insufficiently qualified persons can not assess the risks involved in handling sheet metal shears and expose themselves and others to the risk of serious or fatal injuries.

- All work should only be carried out by qualified persons.



### NOTE!

After servicing, maintenance and repair, check that all panels and guards are correctly installed on the machine and that there are no tools inside or in the working area of the sheet metal shears.

Damaged protective devices and parts of the device must be repaired or replaced as agreed by a recognized specialist workshop.

### 9.1 Care by cleaning

Clean the sheet metal shears regularly with a soft, damp cloth. Treat bare metallic work surfaces with anti-rust spray. Never use solvents to clean plastic parts or painted surfaces. A surface release and consequential damage may occur.

### 9.2 Lubrication schedule

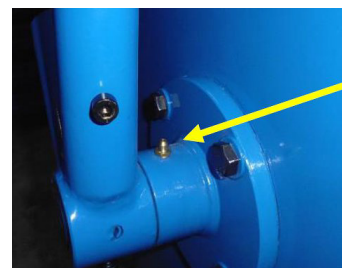

Fig. 11: Grease nipple for hand lever

All moving parts of the metal shears must be lubricated regularly.

Maintenance interval	Maintenance tasks
Before the operation	Oil knife and lubricate hand lever bearing (grease nipple)
Before the operation	Lubricate gears
Weekly	Oil down mechanism
Weekly	Lubricate eccentric bearing
Monthly	Lubricate plain bearing of the back gauge

## 10 Troubleshooting

Fault	Remedy
Burr at the cutting edge	<ol style="list-style-type: none"> <li>Cutting gap too large, adjust cutting gap.</li> <li>Blunt knives, change knives</li> </ol>
Cut off sheet metal does not have the set dimension.	Adjust the stop.

## 11 Disposal, recycling of old equipment

In the interests of the environment, care must be taken to ensure that all components of the machine are disposed of in the proper and approved way.

### 11.1 Decommission

Disused equipment must be taken out of service immediately in order to avoid later misuse and endangering the environment or people.

- Dispose of all environmentally hazardous fluids from the old device.
- If necessary, disassemble the machine into manageable and usable components and components.
- Supply the machine components and operating materials to the appropriate disposal channels.

### 11.2 Disposal of lubricants

Remove the leaking, used or excess grease at the lubricated lubrication points.

The disposal instructions for the lubricants used are provided by the lubricant manufacturer. If necessary, ask for the productspecific data sheets.

## 12 Spare parts



### DANGER!

#### Danger of injury by the use of wrong spare parts!

Dangers may result for the user and damages as well as malfunctions may be caused by using wrong or damaged spare parts.

- Only use original spare parts of the manufacturer or spare parts admitted by the manufacturer.
- Always contact the manufacturer in case of uncertainties.



### Tips and recommendations

Using non-approved spare parts voids the manufacturer's warranty.

### 12.1 Ordering spare parts

The spare parts can be obtained from the dealer or directly from the manufacturer. The contact details are in chapter 1.2 Customer Service.

Specify the following key data for inquiries or when ordering spare parts:

- Type of device
- Article number
- Part number
- Quantity
- Year of manufacturing
- Required mode of dispatch (mail, freight, sea, air, express)
- Address of dispatch

Spare parts orders without above given information can not be considered. If the shipping method is missing, shipping will be at the discretion of the supplier.

Information on the device type, article number and year of manufacture can be found on the type plate, which is attached to the device.

### Example

The upper knife for the Manual sheet metal shear TBS 1501-15 must be ordered. The upper knife has the number 47 in the spare parts drawing 1.

By ordering spare parts, send a copy of the spare parts drawing (1) with the marked part (upper knife) and marked position number (47) to the dealer or spare parts department and provide the following information:

- Type of device: **Manual sheet metal shears TBS 1501-15**
- Item number: **3746015**
- Drawing number: **1**
- Position number: **47**

### Item number of your device:

Manual sheet metal shears TBS 1501-15: **3746015**

Manual sheet metal shears TBS 2001-12: **3746020**

## 12.2 Spare parts drawing

The following drawing should help in case of service to identify necessary spare parts. To order, send a copy of the parts drawing with the parts marked to your authorized dealer.

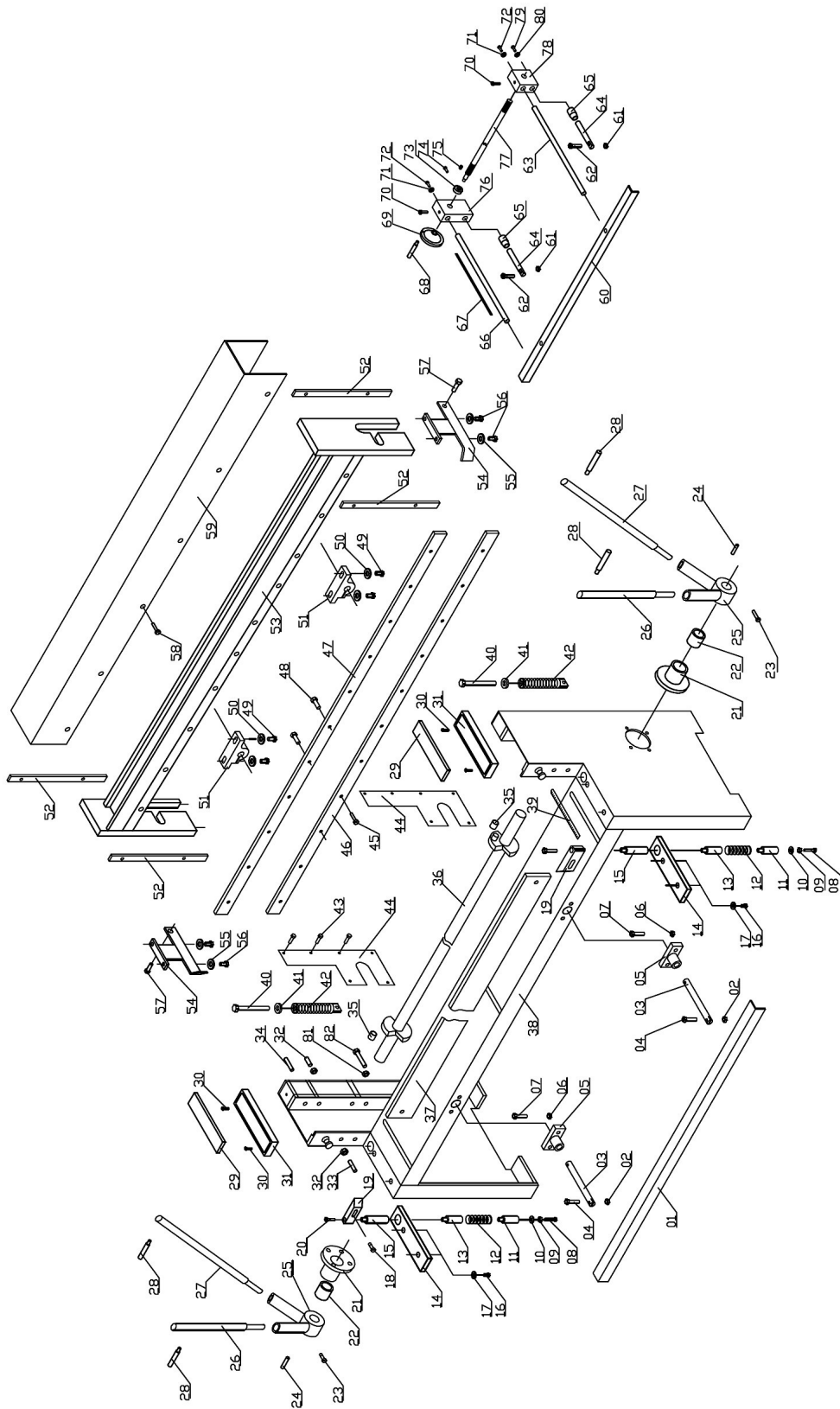

Fig. 12: Spare parts drawing TBS 1501-15 and TBS 2001-12





## 14 Notes

