

Neets Audio Amplifier 2:25

Neets Audio Preamplifier

Installation Manual



Neets

Foreword

This document describes how to install and operate the Neets Amp 2:25 and the Neets Preamp.

COPYRIGHT - All information contained in this manual is the intellectual property and copyrighted material of Neets. All rights are reserved. You may not allow any third party access to content, information or data in this manual without Neets' express written consent.

CHANGES - Neets reserve the right to change the specification and functions of this product without prior notice.

Questions, AFTER reading this manual, can be addressed to your local distributor or:

Neets A/S
Langballe 4
8700 Horsens
Denmark

by E-Mail: Support@Neets.dk
or you may use our contact form at www.neets.dk

Revision list

This document (no: 230-028-312-0010) has the following revision changes:

Author: Date	Description	Pages	Rev
MH: 27-04-2016	First release.	All	1.00

What is in the box?

When you open the box it will contain the following items:

Neets Audio Amplifier 2:25

1 x Neets Audio Amplifier 2:25
24V Power adapter
Power cable for adapter
Terminal connectors
Screws and plugs for wall mounting
Screws for mounting on Neets Rack Shelf.
Manual

Neets Audio Preamplifier

1 x Neets Audio Preamplifier
12V Power adapter
Terminal connectors
Screws and plugs for wall mounting
Screws for mounting on Neets Rack Shelf.
Manual

Important Safety Instructions

Caution:

Read these instructions:

Read and understand all safety and operating instructions before using the equipment.

Keep these Instructions:

The safety instructions should be kept for future reference.

Heed all Warnings:

Follow all warnings and instructions marked on the equipment or in the user information.

Avoid Attachments:

Do not use tools or attachments that are not recommended, because they may be hazardous

Warning!:

- This equipment should be operated only from the included power supply.
- To remove power from the equipment safely, remove all power cords from the rear of the equipment, or the desktop power module (if detachable), or from the power source receptacle (wall plug).
- Power cords should be routed so that they are not likely to be stepped on or pinched by items placed upon or against them.
- Do not defeat the safety purpose of a polarized or grounding-type plug. A polarized plug has two blades with one wider than the other. A grounding-type plug has two blades and a third grounding prong. The wide blade or the third prong is provided for your safety. If the provided plug does not fit into your outlet, consult an electrician for replacement of the obsolete outlet.
- Unplug this apparatus during lightning storms or when unused for long periods of time.
- Refer all servicing to qualified service personnel. There are no user-serviceable parts inside. To prevent the risk of shock, do not attempt to service this equipment yourself because opening or removing covers may expose you to dangerous voltage or other hazards. Contact your local Neets reseller or distributor.
- If the equipment has slots or holes in the enclosure, these are provided to prevent overheating of sensitive components inside. These openings must never be blocked by other objects.
- Do not use this equipment near water.
- To reduce the risk of fire or electric shock, do not expose this apparatus to rain or moisture and objects filled with liquids.
- Unplug the product before cleaning. Clean only with a dry cloth and not cleaning fluid or aerosols. Such products could enter the unit and cause damage, fire, or electric shock. Some substances may also mar the finish of the product.

FCC Class A Notice:

This equipment has been tested and found to comply with the limits for a Class A digital device, pursuant to part 15 of the FCC Rules. Operation is subject to the following two conditions:

1. This device may not cause harmful interference.
2. This device must accept any interference received, including interference that may cause undesired operation. The Class A limits are designed to provide reasonable protection against harmful interference when the equipment is operated in a commercial environment. This equipment generates, uses, and can radiate radio frequency energy and, if not installed and used in accordance with the instruction manual, may cause harmful interference to radio communications. Operation of this equipment in a residential area is likely to cause harmful interference, in which case the user will be required to correct the interference at his own expense.

FCC regulations state that any unauthorized changes or modifications to this equipment, not expressly approved by the manufacturer, could void the user's authority to operate this equipment.



The lightning bolt triangle is used to alert the user to the presence of uninsulated "dangerous voltages" within the unit's chassis that may be of sufficient magnitude to constitute a risk of electric shock to humans.



The exclamation point triangle is used to alert the user to presence of important operating and service instructions in the literature accompanying the product.

Contents

Foreword	2
Revision list	2
What is in the box?	2
Important Safety Instructions	3
Contents	4
Description.	5
Specifications - Neets Audio Amplifier 2:25	6
Specifications - Neets Audio Amplifier 2:25	7
Installation	8
Connection and Controls	8
Front	9
Rear.	10
How to connect.	13
Speaker output.	13
Preamplifier Pre-Out connected to power amplifier.	13
RS-232 connection	14
How to use.	16
Controlled from the front panel.	16
Controlled from the built in webserver.	16
Controlled from LAN by remote protocol	17
Controlled from RS-232 by remote protocol	17
Special functions.	18
Troubleshooting.	19
Error indication.	19
LAN and RS-232 protocol	20
Command structure	20
Global functions	21
Audio inpput settings	22
Audio output settings	23
I/O settings	23
I/O control	24
Screen settings	25
LAN settings	26
RS-232 settings.	27
IR commands (Advanced users)	28

Description

Neets Audio Amplifier – 2:25 and Preamplifier is network controlled stereo audio amplifier/preamplifier controlled through LAN or RS-232. They adds additional RS-232 and I/O ports for expansion and integrates with Neets and 3rd party control systems.

The USB audio input enables direct audio input and external volume control from a computer (PC or Mac).

Audio Amplifier – 2:25 has a Class D amplifier with built-in DSP.

The Preamplifier utilizes the same DSP with balanced audio output. The Preamplifier can be powered by Power over Ethernet (PoE) or the included 12V PSU.

Audio Amplifier – 2:25

- 2-channel stereo amplifier
2x25 Watts @8 ohm or 2x35 Watts @4 ohm both in stereo
- Bridge mode
1x34 Watts @8 ohm or 1x56 Watts @4 ohm both in bridge mode

Preamplifier

- 1 Balanced stereo audio output
Stereo balanced or single ended line level output on terminal blocks
- Power over Ethernet
Power can be supplied through PoE
- 12V DC power in/out
When powered by PoE the 12V DC output supplies power for external devices such as control system. When not powered by PoE the included 12V PSU can be used for power input

Both models

- USB audio
Provides audio playback and volume control on connected PC or Mac
- 1 LAN port
Enables control of the amplifier and adds two extra RS-232 ports for expansion of the control system
- 2 Bi-directional RS-232 ports
Used for control or expanding the AV system with more devices
- 4 General Purpose I/O ports
Used for extra input/output ports for control of relays, switches and sensors.
- Input 1 Mix function
Input 1 may be set to mix with any other currently selected input.
- 3 band equalizer
Works as an active filter for bass, mid and treble
- Front LED indicators
Convenient location for easy performance indication
- Easy mounting
Can be mounted in trunking systems, hidden under shelving or in furniture, or mounted or in 1RU using the Neets Rack Shelf
- Configuration
Built-in configuration area fully integrates with Neets Project Designer

Specifications

Neets Audio Amplifier 2:25

Speaker output

Output power	
Stereo	2 x 25 W @ 8 ohm
Stereo	2 x 35 W @ 4 ohm
Parallel-bridge	1 x 35 W @ 8 ohm
Parallel-bridge	1 x 35 W @ 4 ohm

Analog audio input

Unbalanced inputs	4 stereo inputs
Input impedance	< 100 k Ohm
Max input level	2 Vrms
Input gain adjustable	+/- 12 dB
Wake on signal	Adjustable level
Connector	2 x 4 RCA female

USB audio input

Supported OS	MAC OS-X Windows XP, Vista 7,8,8.1 and 10
Bit depth	16 bit
Sample rate	48 kHz
Controls	Volume, mute
Wake on signal	Trigger on 5V USB
Connector	USB-B female

Power input

Input voltage	24 VDC
Max power usage	50 W
Standby power usage	< 3 W
Connector	5,5 mm DC plug

Power adaptor included

Input voltage	100 VAC – 240 VAC
---------------	-------------------

Network (LAN)

Speed	10 / 100 Mbit
Duplex modes	Half or Full
DHCP	Default off
Default IP	192.168.254.252
Default gateway	192.168.254.254
Default subnet mask	255.255.255.0
Connector	RJ45 with LED

RS-232 / IR ports

Ports	2 x bidirectional
Baud rate	1200 – 115200 bit/sec
Data bits	7, 8
Parity	Even, Odd, None
Stop bits	1, 2
IR frequency	400 Hz to 500 KHz
Connector	2 x 3 pin screw blocks

Input/ Output

Ports	4 x I/O
Input trigger low	< 1VDC
Input trigger high	> 4VDC
Output type	Open drain
Isolated output	No
Max voltage load	24 VDC
Max current	0.5 A
Connector	5 pin screw block

General

Width	218 mm
Depth	70 mm
Height	37 mm
Width	8,58 Inches
Depth	2,76 Inches
Height	1,46 Inches

Weight	0.5 kg
Shipping weight	1.35 kg
Shipping dimensions	282 mm/ 18,8 mm/ 55 mm

Storage temperature	-20 °C to 50 °C
Storage moisture	Non condensing
IEC/EN	61000-6-1
IEC/EN	61000-6-2

Specifications

Neets Audio Preamplifier

Line output

Balanced output	1 stereo output
Output impedance	100 Ohm
Output level @ 0 dB/FS	1.3 Vrms/+4 dBu
Connector	5 pin screw block

Analog audio input

Unbalanced inputs	4 stereo inputs
Input impedance	< 100 k Ohm
Max input level	2 Vrms
Input gain adjustable	+/- 12 dB
Wake on signal	Adjustable level
Connector	2 x 4 RCA female

USB audio input

Supported OS	MAC OS-X Windows XP, Vista 7,8,8.1 and 10
Bit depth	16 bit
Sample rate	48 kHz
Controls	Volume, mute
Wake on signal	Trigger on 5V USB
Connector	USB-B female

Power input/ output

Input voltage	12 VDC
Max power usage	5 W
Standby power usage	< 3 W
Connector	2 pin screw block

Power adaptor included

Input voltage	100 VAC – 240 VAC
Line frequency	50 Hz – 60 Hz
Max power usage	Max 25 W
Connector	Prong matching country of sale

Network (LAN)

Speed	10 / 100 Mbit
Duplex modes	Half or Full
DHCP	Default off
Default IP	192.168.254.252
Default gateway	192.168.254.252
Default subnet mask	255.255.255.0
Connector	RJ45 with LED

RS-232 / IR ports

Ports	2 x bidirectional
Baud rate	1200 – 115200 bit/sec
Data bits	7, 8
Parity	Even, Odd, None
Stop bits	1, 2
IR frequency	400 Hz to 500 KHz
Connector	2 x 3 pin screw blocks

Input/ Output

Ports	4 x I/O
Input trigger low	< 1VDC
Input trigger high	> 4VDC
Output type	Open drain
Isolated output	No
Max voltage load	24 VDC
Max current	0.5 A
Connector	5 pin screw block

General

Width	218 mm
Depth	70 mm
Height	37 mm
Width	8,58 Inches
Depth	2,76 Inches
Height	1,46 Inches
Weight	0.5 kg
Shipping weight	1.25 kg
Shipping dimensions	282mm/ 18,8 mm/ 55 mm
Storage temperature	-20 °C to 50 °C
Storage moisture	Non condensing
IEC/EN	61000-6-1
IEC/EN	61000-6-2
IEC/EN	61000-6-1
IEC/EN	61000-6-2

Approvals

IEC/EN	61000-6-1
IEC/EN	61000-6-2

Installation

The amplifier or preamplifier unit is designed to be easily installed in any convenient location. It can be placed on a desk free standing. Simply unpack the unit, mount the adhesive feet and it is ready to go.

Alternatively, the unit can be mounted under a table, on a ceiling etc. with the included self-tapping screws. Unpack the unit, place the unit on the surface where it should be mounted, and screw the two screws through the holes in the top as shown below:

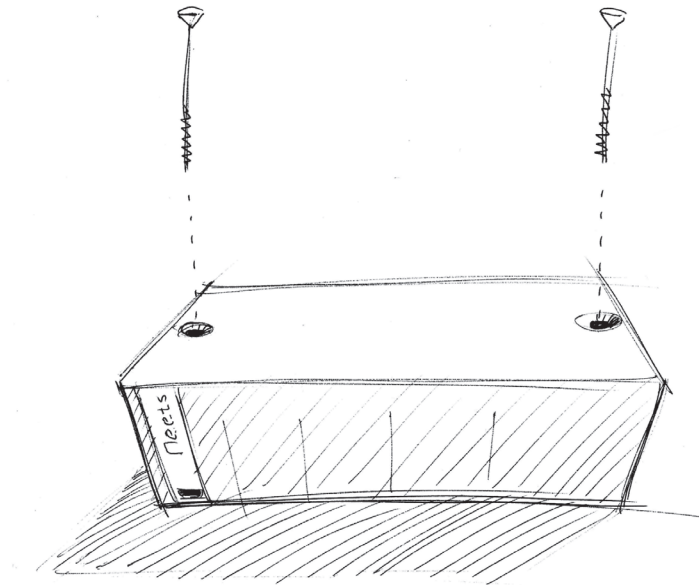

The unit also can be mounted in a 19 inch standard rack using the Neets Rack Shelf (Part number: 306-0017). See separate manual for installation instructions.

Connection and Controls

Front

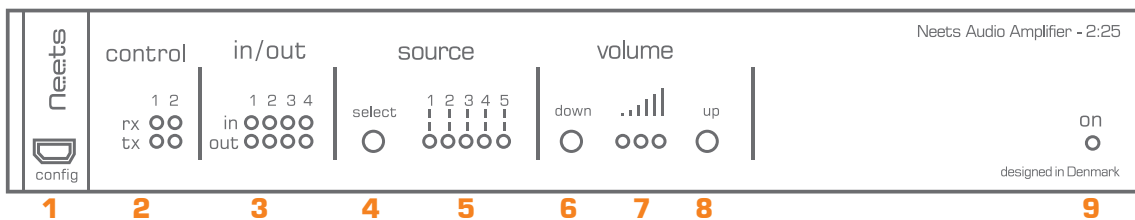

Number:	Description
1	USB configuration input
2	RS-232 status indication
3	IO status indication
4	Button for source selection
5	Source selection indication
6	Button for volume adjustment, down
7	Volume level indication
8	Button for volume adjustment, up
9	Power and error indication

Front USB configuration

The front panel USB connector marked “config” is used for configuring the amplifier and updating the firmware.

A built in web server enables quick configuration using your favorite browser on a Windows based PC, accessible when connected through the USB config port. For complete configuration details, please refer to “Control from the built in webserver” on page 16.

The USB connector for connecting to the amplifier is “mini USB B 5P”. You can buy this cable on the web (select a USB A to Mini USB B 5P).

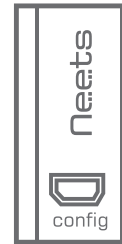

RS-232 status indication

The RS-232 status LED displays the current status of the RS-232 ports. The LEDs illuminate when there is active communication on the port.

IO status indication

The IO status LED displays current status of the I/Os.

When an IO is configured as input, the yellow LED marked “in” will illuminate when the input is high and turn off when the input is low. The green LED marked “out” will remain off.

When an IO is configured as output, the green LED marked “out” will illuminate when the output is high and turn off when the output is low. The yellow LED marked “in” will remain off.

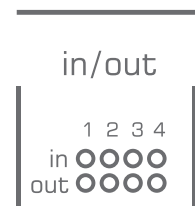
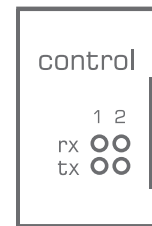

Source control and indication

The input audio source can be selected directly on the front panel with the button marked “select”.

The LED for the selected source will illuminate yellow.

SOURCE



Volume control and indication

The output volume can be adjusted directly from the front using the buttons marked “down” and “up”.

The current volume level will be indicated on the three green volume level LEDs.

VOLUME



Power and error indication

The “on” LED will show the current status of the amplifier.

Green	The amplifier is on and running normally.
Red	The amplifier is in standby mode.
Blue	The amplifier is starting.
Flashing red	The amplifier is in error mode, see section “Error indication” on page 19 for details.

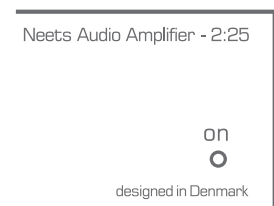

Rear

Neets Audio Amplifier 2:25

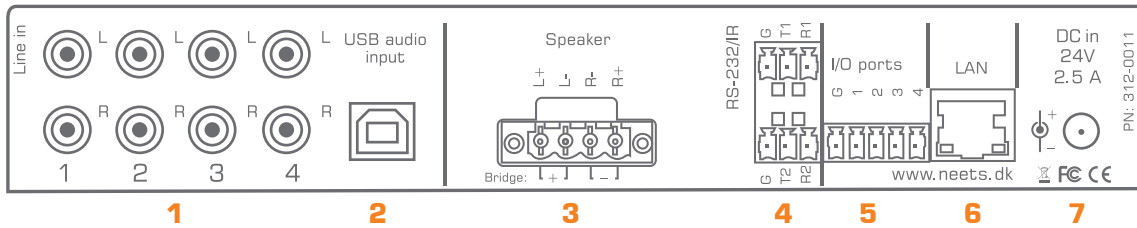

Neets Audio Preamplifier

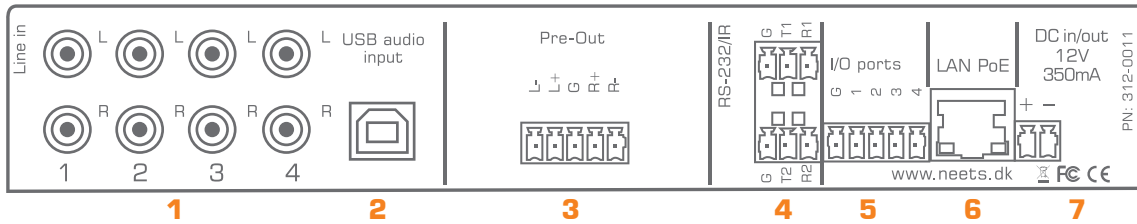

Number:	Description
1	4 x stereo line level audio input
2	1 x USB audio input
3 Amplifier 2:25	1 x stereo speaker level output
3 Preamplifier	1 x stereo balanced line level output
4	2 x bi-directional RS-232 or IR transmitter
5	4 x digital I/O
6 Amplifier – 2:25	1 x RJ-45 Network (LAN) connector
6 Preamplifier	1 x RJ-45 Network (LAN) connector w. PoE
7 Amplifier – 2:25	24 V DC power input
7 Preamplifier	12 V DC power input or output

Line audio input

The connectors marked “Line in” are line level audio inputs. Connect your audio sources here with an RCA cable.

White inputs are left channel, red inputs are right channel.

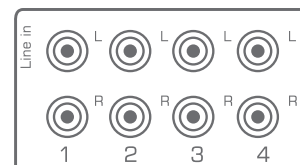

USB audio input

The USB audio connector is used to connect the amplifier to your PC or MAC for use as a USB audio source.

Connect using a USB A male to USB B male cable. Remember not to exceed the maximum USB cable length of 5 meters.

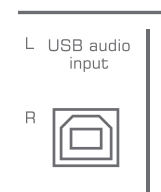

Speaker output (Amplifier - 2:25 only)

The loudspeakers are connected to the Speaker output using the supplied mating Euroblock connector. The loudspeaker cables can be securely fastened to the amplifier by tightening the two screws built into the connector; this is important when connecting heavier speaker cables.

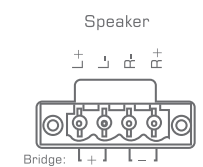

Pre-Out (Preamplifier only)

The Pre-Out connection of the Preamplifier connects to a separate power amplifier using the supplied Euroblock connector. If the connected power amplifier supports balanced inputs, this is the preferred connection method. Use good quality interconnect cables with proper shielding for best performance.

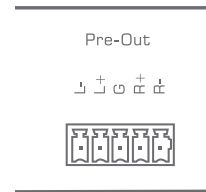

RS-232 connectors

The onboard RS-232 ports (T1, R1, T2, R2) can be used for one- or two-way communication with external RS-232 compatible devices, or used alternatively as IR ports. T1 and R1 are used as defaults to control the amplifier. T2 and R2 are used when daisy chaining multiple units or when using the unit as LAN to RS-232 gateway.

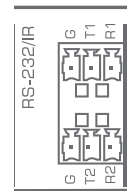

I/O Connectors

The amplifier has four I/Os available. These are multifunctional digital inputs or outputs which can be configured for different purposes. The I/Os can be configured for general purpose functionality with control from either LAN or RS232RS-232 connections. For example, it is possible to connect an external control keypad, PIR (movement) sensor, keyboard lock, or extra relays to the amplifier with everything controlled remotely from a connected control system.

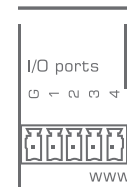

The ports are not potential free; you may need external relays if you need to prevent ground loops. When used as outputs, the ports are active low. When indicated as active, the pins are tied to GND.

LAN connector

The LAN connector is used to connect the amplifier to the local area network. The LAN interface enables control of the amplifier either from a connected control system or the built in web interface.

On the Preamplifier, the LAN interface also supports Power over Ethernet (PoE) function. The Preamplifier can be powered from a PoE enabled switch or PoE injector using only the LAN connection.

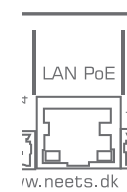

The LAN port features auto MDI-X which means that you can connect the LAN port directly to a control system without the need for a switch.

There are two LEDs on the connector with the following indication:

Color	Off	On	Blink
Yellow	No link	Link	Activity
Green	10Mbit	100Mbit	

24 V DC input connector (Audio Amplifier - 2:25 only)

Power is supplied through this connector. Connect the supplied Neets mains power adaptor with the round DC input and connect the mains cable to the AC supply only after all other connections to the amplifier have been made.

Use only the included Neets mains power adaptor to supply power to the amplifier.

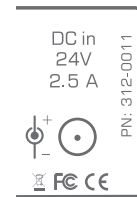

12 V DC input/output connector (Preamplifier only)

On the Preamplifier, this connector can be used to supply power to the unit using the included mains power adaptor. Alternatively, the connector can be used to power external 12 V equipment from the internal PoE supply when using the Preamplifier with a PoE-enabled LAN connection.

When using the connector as power supply to other equipment, please note that the maximum output current is 350 mA. The output has an auto re-settable fuse which will protect the connection from overloading when used as a power output.

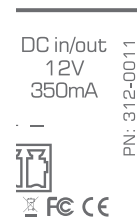

How to connect

Speaker output

When using the amplifier in normal stereo mode, connect left speaker positive to L+ terminal and negative to L- terminal. Right speaker positive connects to R+ terminal and negative to R- terminal:

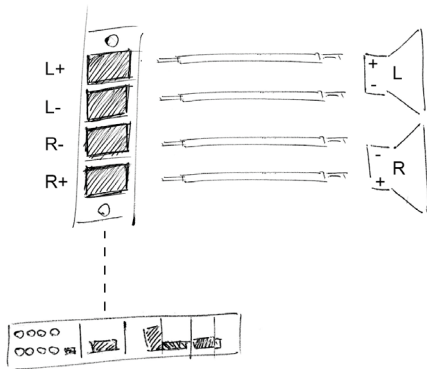

When using the amplifier in parallel-bridge mode connect the speaker as shown by the “bridge” indicators: Speaker positive to both L+ and L- terminal and speaker negative to both R+ and R- terminal using a piece of speaker wire as jumper on the terminals. **Please note that this connection method differs from traditional bridge mode connections.**

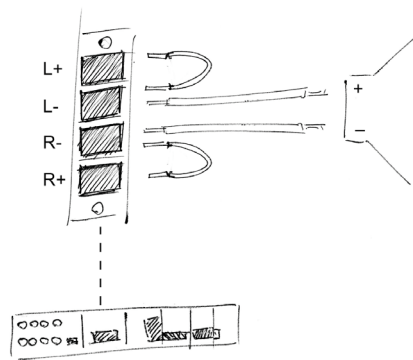

Use at least AWG 18 / 0.75 mm² speaker cable for cable lengths under 5 meters. Above 5 meters use at least AWG15 / 1.5 mm². If the speaker manufacturer specifies even thicker cables, follow the recommendation from the speaker manufacturer.

Preamplifier Pre-Out connected to power amplifier

To connect as a balanced output, connect ground to the shields of both cables. Connect L+ to Left positive/hot input, L- to Left negative/cold input, R+ to right positive/hot input and R- to right negative/cold input. Depending on the connector used on the power amplifier, use one of connection diagrams below:

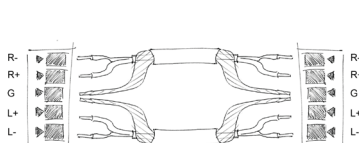

Euroblock

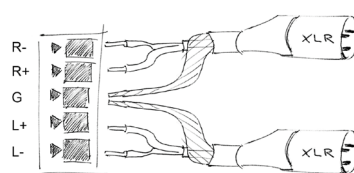

XLR

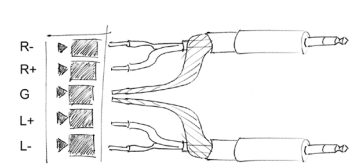

Jack input

To connect as single ended/unbalanced output with RCA connectors, connect ground to the cable shield and L+ input tab, L- is left unconnected, R+ to right input tab and R- is left unconnected.

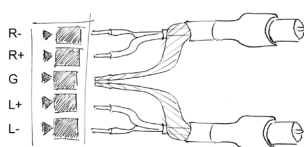

RS-232 connection

Controlling the amplifier or preamplifier from a control system by RS-232

To control the amplifier or preamplifier unit by RS-232, connect the RS-232 port from the control system to the unit's RS-232 port 1 (T1, R1 and G).

The required commands for RS-232 control can be found in section "LAN and RS-232 protocol" on page 20.

Remember, it is not possible to control the amplifier or preamplifier by both RS-232 and LAN at the same time.

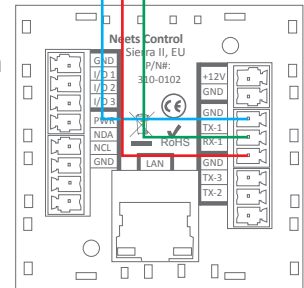
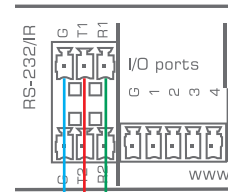

Using the amplifier or preamplifier as a LAN to RS-232/IR gateway

Both of the RS-232/IR ports can be used as either RS-232 or as IR emitter gateways in conjunction with the LAN port.

<p>When used as single IR port: Connect the IR emitter white striped wire to T1 or T2 and the black wire to G as shown above.</p>	<p>When used as dual IR port: Connect the first IR emitter white striped wire to T1 or T2 and first IR emitter black wire to second IR emitter white striped wire; connect second IR emitter black wire to G, as shown above.</p>	<p>When used as RS-232 port: Connect the device to T1/T2, R1/R2 and G, as shown above. Please check manual of equipment to control for the correct pin connection.</p>

Using the amplifier or preamplifier with RS-232 loop-through

By default, one RS-232 line from the control system allows connection to only one receiver, in this case the amplifier or preamplifier unit. However, by using the unit's second RS-232 port as a loop-through port, you can connect and control a second device such as a display or a projector.

So, how do we do this? The unit's RS-232 port 1 analyzes and responds only to those commands from the control system that it recognizes as applying to its own functions. The remaining commands, not applicable to amplifier or preamplifier functions, are retransmitted on RS-232 port 2. The benefit of this operating mode is that you can set any communications parameter (like baud rate) on RS-232 port 2.

Each unit can be assigned an ID number (Default 1) that allows you to define which unit should respond to a given command.

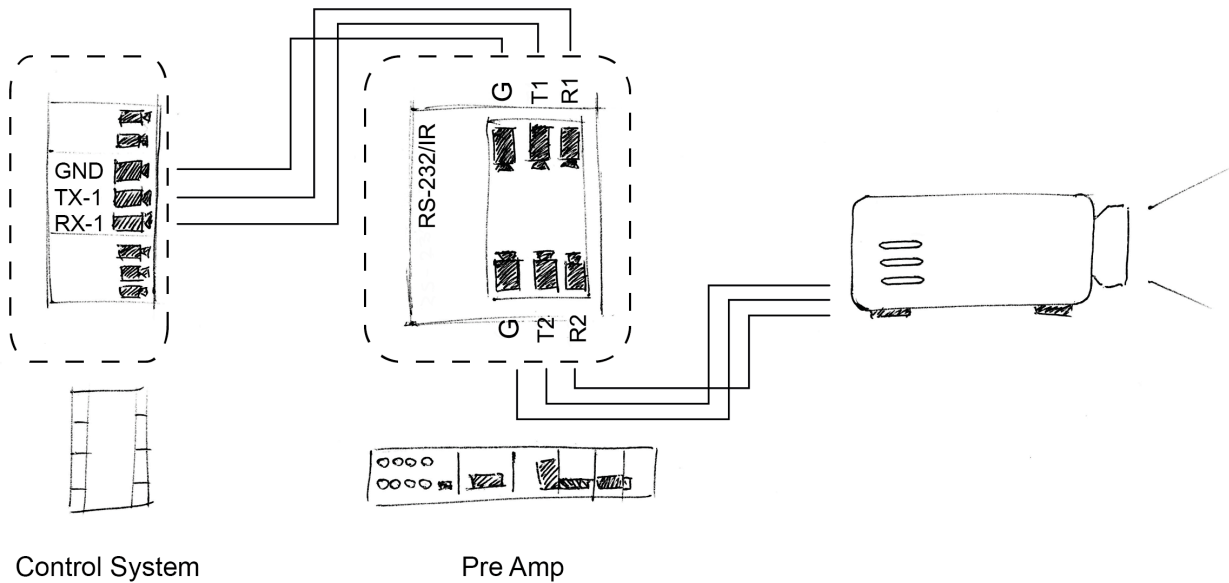

I/O Connection

Using the amplifier or preamplifier as a RS-232 or LAN to IO gateway

External equipment can be controlled through the unit's IOs by either RS-232 or LAN. For example, a Neets Switching Relay – 2 can be controlled when connected as shown here.

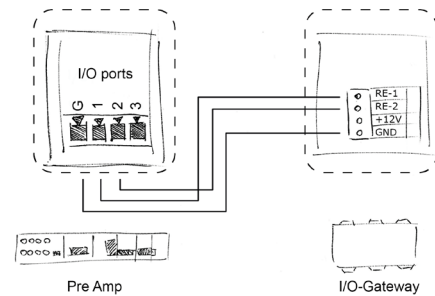

Powering external control systems from the preamplifier

When powering the preamplifier from a PoE capable switch or power injector, the preamplifier can be used to source power for a connected control system. Connect the control system to the preamplifier as shown here.

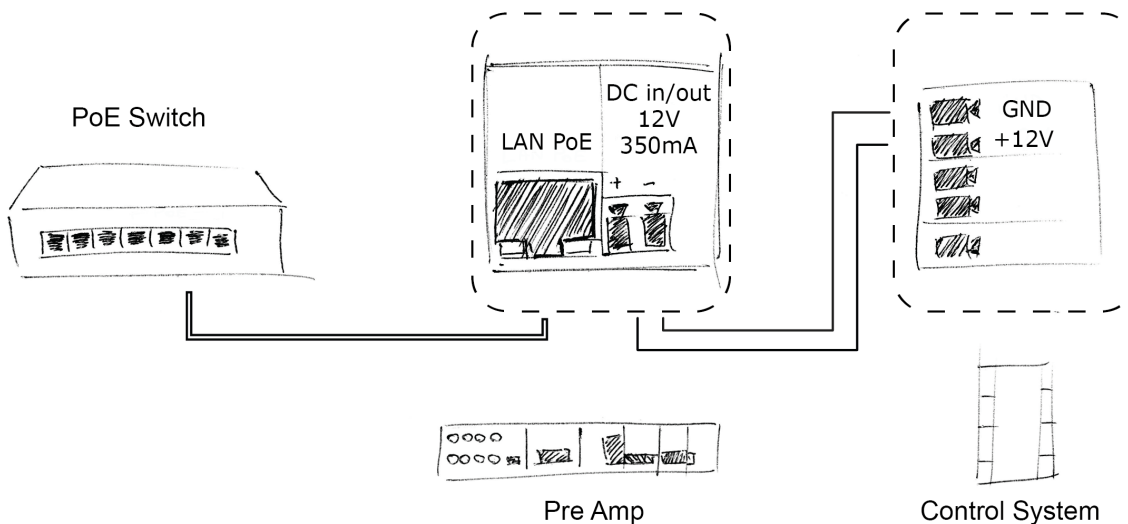

How to use

Control from the front panel

The amplifier or preamplifier may be used in stand-alone mode without control systems connected. Front panel controls are provided for power, source selection, volume and mute status.

Power on and off

To toggle the amplifier's or preamplifier's power state, press and hold the unit's source select button for three seconds. The LED illuminates green when the unit is ON and red when it is OFF (standby).

Change source

The audio sources are selected with the "source" button. The selected source advances with each press of the button, e.g. from 1 to 2, 2 to 3, 3 to 4, 4 to 5 (USB) and back from 5 to 1.

Adjust volume level

Volume level can be adjusted by the "down" and "up" buttons. Each press of an "up" or "down" button adjusts the volume in 1 dB steps, either to higher or lower level. If the "down" button is held for a longer period of time, the volume will decrease at a faster rate of 5 dB/second.

Mute the audio output

To toggle between mute and unmute on the unit's output, press both "down" and "up" buttons simultaneously. The three volume level LEDs will blink to indicate the output is muted.

Adjust analog input gain

The gain on the four analog inputs may be adjusted from the front panel.

To adjust the input gain for the currently selected analog input, press and hold the "source" button. While pressed adjust the input gain by pressing the volume "down" or "up" buttons to set the desired gain. Release the "source" button.

Note: Gain must be "set by ear" or with external measurement of the outputs as there is no indication of the actual input gain on the LEDs.

Control from the built in webserver

The amplifier or preamplifier unit can be controlled from the built-in home page using a standard web browser. The homepage can be accessed through the LAN connection on all platforms or through the front USB configuration input using a Windows PC.

To access by USB, simply connect the unit to your PC. If you have installed Neets Project Designer, all necessary drivers are already installed on your PC. (Note: If not available, please visit www.neets.dk and navigate to the download page for the amplifier. Here you find the driver files along with detailed information on how to install the driver.)

To access the unit's webserver home page, open your browser and type in: <http://neetsweb/> or <http://192.168.0.4/> and the amplifier homepage should pop up.

To access by LAN, connect the amplifier to your LAN and type in the IP address of the unit and the homepage should pop up. LAN access requires that you know the IP address of your amplifier or preamplifier and that this address is within the IP range of your network. If this is not the case please change the settings using USB config connection first.



Control from LAN by remote protocol

Connect the amplifier or preamplifier to the local area network to allow control via LAN.

- Network Protocol: TCP
- Control port: 5000 (only one active connection at a time)

The commands for LAN control can be found on page 20.

Control from RS-232 by remote protocol

Connect a RS-232 device to RS-232 port 1 with the following default settings.

- Baudrate: 19.200
- Databit: 8
- Stopbit: 1
- Parity: None

The amplifier can be controlled from RS-232 port 1 only. Please be aware that RS-232 control is deactivated if the amplifier is also controlled by a LAN connection.

The commands for RS-232 control can be found on page 20.

Special functions

Change the ID number of the amplifier

When controlling the amplifier by the external protocol on either RS-232 or LAN, the unit responds to commands that are sent to it according to its assigned unit ID number. By default the amplifier has unit ID 1. The ID number can be changed by RS-232, LAN or the front panel buttons.

To change the unit ID by RS-232 or LAN see the protocol on page 21.

To change the unit ID with the front panel buttons:

- Connect power to the amplifier. If currently connected, disconnect and then reconnect.
- Within five seconds of power connection, press and hold the source button until one of the source LEDs starts blinking. The blinking light LED corresponds to the current unit ID number.
- Toggle through the source LEDs by pressing the source button, selecting any "source" from 1 to 5. The source number corresponds to the new unit ID number.
- Press and hold the source button for 5 seconds to store the selection as the new unit ID.

When the amplifier is powering up, it indicates its current unit ID on the source status LEDs by illuminating the source LED with same source number as the unit ID.

Reset to factory default

To reset all amplifier settings to factory default settings either use the FACTORYDEFAULT command as described in section "System functions" on page 22 or follow the below procedure:

- Power up the amplifier.
- Then press and hold all three front panel buttons for 5 seconds.
- The amplifier will now reboot and have all settings restored to factory default.

Upgrade the firmware

Use the Neets Project Designer program to update the firmware by following this procedure.





- Start Neets Project Designer on your PC.
- Connect the amplifier USB config port on the front to a PC USB port.
- If a new firmware is available for the amplifier a dialog box will appear in the Project Designer with a guide for the firmware update process.

Troubleshooting

Error indication

Errors occurring in the amplifier or preamplifier are displayed by the front LEDs.

In all error modes the power LED will flash red alternating with the source LEDs. The alternating source LED will indicate type of error:

Indication	Error
 <p>The diagram shows the front panel of the Neets Audio Amplifier with the following LED states: 'control' (1, 2) and 'tx' (1, 2) are off; 'in/out' (1, 2, 3, 4) are on; 'source' (1, 2, 3, 4, 5) are on, with the first LED (1) flashing red; 'down' and 'up' are off. A red starburst icon is shown in the bottom right corner.</p>	<p>Amplifier overload.</p> <p>The amplifier has been overloaded by a short circuit on the output, excessive -temperature, or overvoltage events on the power supply.</p> <p>Please remove power from the amplifier, check all connections and loads, and re-apply power.</p> <p>If the error is not resolved, contact Neets or your local distributor.</p>
 <p>The diagram shows the front panel of the Neets Audio Amplifier with the following LED states: 'control' (1, 2) and 'tx' (1, 2) are off; 'in/out' (1, 2, 3, 4) are on; 'source' (1, 2, 3, 4, 5) are on, with the second LED (2) flashing red; 'down' and 'up' are off. A red starburst icon is shown in the bottom right corner.</p>	<p>Internal storage error. Contact Neets or your local distributor.</p>
 <p>The diagram shows the front panel of the Neets Audio Amplifier with the following LED states: 'control' (1, 2) and 'tx' (1, 2) are off; 'in/out' (1, 2, 3, 4) are on; 'source' (1, 2, 3, 4, 5) are on, with the third LED (3) flashing red; 'down' and 'up' are off. A red starburst icon is shown in the bottom right corner.</p>	<p>FW update error (No application found) Contact Neets or your local distributor.</p>
 <p>The diagram shows the front panel of the Neets Audio Amplifier with the following LED states: 'control' (1, 2) and 'tx' (1, 2) are off; 'in/out' (1, 2, 3, 4) are on; 'source' (1, 2, 3, 4, 5) are on, with the fourth LED (4) flashing red; 'down' and 'up' are off. A red starburst icon is shown in the bottom right corner.</p>	<p>Unexpected error.</p> <p>Turn off the power to amplifier for 20 sec before turning the power on again.</p> <p>If the error is not resolved, contact Neets or your local distributor.</p>

LAN and RS-232 protocol

Command structure

To understand and apply the commands below please keep the following rules in mind:

Symbol	Description:
<A>	When constructing the command, this part must be replaced with a number indicating the UNIT ID.
	When constructing the command, this part must be replaced with a string or number indicating the number of control.
<X>	When constructing the command, this part must be replaced with a string or number matching the command.
\CR	Every command line must end with a carriage return. Carriage return is commonly referred to as "CR". If you need to enter it in hex, the value is 0D; in decimal, it is 13.
"," or ,	When making a command it consists of several parts. Each part is separated with a comma. E.g. NEUNIT=1,INPUT=4\CR

Please be aware that all the commands are case sensitive. If the amplifier detects an error in the command line, the entire command will be ignored.

It is possible to send multiple commands without time delay between commands. However, remember that each command must end with \CR.

Examples:

Below you will find a few sample commands for controlling the amplifier. These are just a few examples to show how the interface functions. For more details on the command please refer to the following sections.

Examples of commands than can be sent on ether LAN or RS-232 .

Command: NEUNIT=1,VOL=-20 \CR

Reply: NEUNIT=1,OK\CR

Command: NEUNIT=1,INPUT=? \CR

Reply: NEUNIT=1,INPUT=3\CR

Global functions

Global functions allow user adjustment of all basic functions of the amplifier and preamplifier. Global functions also include system settings such as restoring to factory default or readout of software version number.

All commands start of the with: NEUNIT=<A> ,

Where <A> is the UNIT ID (default is 1). All commands must end with a \CR.

Description:	Syntax	<X>	Default <X>	R/W
Power amplifier on and off.	POWER=<X>	ON or OFF	OFF	R/W
Select audio input.	INPUT=<X>	1 to 5	1	R/W
Set output volume.	VOL=<X>	-70 to +12	-50	R/W
Mute audio output on or off.	MUTE=<X>	ON or OFF	OFF	R/W
Set output volume for input 1 in mix mode.	MIXVOL=<X>	-70 to +12	-50	R/W
Mute audio output from input 1 in mix mode on or off.	MIXMUTE=<X>	ON or OFF	OFF	R/W
Restore factory defaults values for the entire system.	FACTORYDEFAULT=TRUE			W
Save the current settings as the default startup values.	SAVE=TRUE			W
Get/set unit ID You can set the unit ID number either at the front of the unit source select buttons as explained on page 20. RS-232 or LAN allows setting of any ID that does not exceed 9 ascii characters. e.g.: NEUNIT=1, UNITID=Neets1\CR NEUNIT=1, UNITID=RoomA\CR	UNITID=<X>	Up to 9 characters long.	1	R/W
Unit, SN	UNITSN=<X>	xyyzzzzz		R
Unit software version.	SWVERSION=?	x.y.z		R
Set to use PUSH or PULL mode for feedback signaling. This is a global setting that applies for all inputs which can give feedback. In PULL mode you have to query the status of each input before executing a command. In PUSH mode the amplifier will send a message when there is a signal change on one of the inputs.	MESSAGE=<A>	PUSH or PULL	PULL	R/W

Examples of use:

- NEUNIT=1,POWER=ON\CR <- Turns on the amplifier.
- NEUNIT=1,INPUT=4\CR <- Sets the audio input to input 4.
- NEUNIT=1,VOL=-23\CR <- Sets the master volume to -23 dB.
- NEUNIT=1,MUTE=ON\CR <- Mutes audio output.
- NEUNIT=1,FACTORYDEFAULT=TRUE\CR <- Sest the amplifier to factory defaults.
- NEUNIT=1,SWVERSION=?\CR <- Queries the amplifier SW version.

Audio input settings

Audio input settings are used to adjust settings like input gain, enable mixer function and wake on signal settings.

All commands start with: NEUNIT=<A>,SETTINGS=INPUT,INPUT= ,

Where <A> is the unit ID, default 1 and is the number of the INPUT you want to configure. All commands must end with a \CR.

Description:	Syntax	<X>	Default <X>	R/W
Set analog input gain for input 1 to 4.	GAIN=<X>	-12 to +12	0	R/W
Activate mixer function for input 1. Note: Only works for = 1	MIX=<X>	TRUE or FALSE	FALSE	R/W
Activate wake on signal at the input.	WOS=<X>	ON OR OFF	OFF	R/W
Set wake on signal trigger level for input 1 to 4. Note: Only works for = 1, 2, 3 or 4	LEVEL=<X>	-70 to -30	-50	R/W
Set wake on signal time out for input 1 to 4. Note: Only works for = 1, 2, 3 or 4	OFFDELAY=<X>	-70 to -30	-50	R/W

Examples of use:

- NEUNIT=1,SETTINGS=INPUT,INPUT=2,ENABLED=FALSE\CR <- Disables input 2.
- NEUNIT=1,SETTINGS=INPUT,INPUT=4,GAIN=+9\CR <- Sets input gain on input 4 to +9 dB.
- NEUNIT=1,SETTINGS=INPUT,INPUT=1,MIX=TRUE\CR <- Activates the mixer function on input 1.
- NEUNIT=1,SETTINGS= INPUT,INPUT=3,WOS=ON\CR <- Enables wake on signal on input 3.
- NEUNIT=1,SETTINGS= INPUT,INPUT=1,LEVEL=-42\CR <- Sets the wake on signal trigger level to -42 dB on input 1.

Audio output settings

Audio output settings adjust amplifier output parameters such as equalizer settings, balance, and output power limit etc.

All commands start with: NEUNIT=<A>,SETTINGS=OUTPUT,

Where <A> is the unit ID, default 1. All commands must end with a \CR

Description:	Syntax	<X>	Default <X>	R/W
Set low band equalizer level.	POWER=<X>	ON or OFF	OFF	R/W
Select audio input.	INPUT=<X>	1 to 5	1	R/W
Set output volume.	VOL=<X>	-70 to +12	-50	R/W
Set output volume for input 1 in mix mode.	MIXVOL=<X>	-70 to +12	-50	R/W
Mute audio output from input 1 in mix mode on or off.	MIXMUTE=<X>	ON or OFF	OFF	R/W
Unit, SN	UNITSN=<X>	xyyzzzzz		R

Examples of use:

- NEUNIT=1,SETTINGS=OUTPUT,LOW=+5\CR <- Sets low band equalizer to +5 dB.
- NEUNIT=1,SETTINGS=OUTPUT,HIGH=-3\CR <- Sets high band equalizer to -3 dB.
- NEUNIT=1,SETTINGS=OUTPUT,BALANCE=-10\CR <- Sets balance of left channel to -10 dB.

I/O settings

I/O settings can be controlled by the following commands.

All commands start with: NEUNIT=<A>,SETTINGS=IO,IO= ,

Where <A> is the unit ID, default 1 and is the number of the IO you want to configure. All commands must end with a \CR.

Description:	Syntax	<X>	Default <X>	R/W
Set the I/O function	FUNCTION=<X>	INPUT, OUTPUT	INPUT	R/W
See page 18 for description of the IO function.				

Example of use:

- NEUNIT=1,SETTINGS=IO,IO=2,FUNCTION=OUTPUT\CR <- Sets IO 2 to output.

I/O control

Below are the possible control commands for I/O if configured as OUTPUT or INPUT.

All commands start with: NEUNIT=<A>,IO= ,

Where <A> is the unit ID, default 1 and is the number of the IO you want to configure. All commands must end with a \CR.

Description:	Syntax	<X>	R/W
Control the output	ACTION=<X>	SET, RELEASE or TOGGLE	R/W
Delay before executed of action (Start delay)	DELAY=<X>	0-6500.0 second	W
Time (changes the action from latch to momentary in this time)	TIME=<X>	0-6500.0 second	W
Read a IO when set as input reply example: NEUNIT=1,IO=1,STATUS=HIGH\CR	STATUS=?	HIGH, LOW	R

Examples of use:

- NEUNIT=1,IO=1,ACTION=TOGGLE\CR <- Toggles state of IO 1
- NEUNIT=1,IO=2,ACTION=SET,TIME=10.5\CR <- Sets IO 2 in 10.5 seconds
- NEUNIT=1,IO=3,STATUS=?\CR <- Queries IO 3 status

Screen settings

The screen control offers an easy and safe way to control electrical screens and lifts using two I/Os. When combining two IOs in screen mode, screen up and down time are defined as part of the same command sequence. After this is set, you can simply send a command indicating the direction the screen should move. The Screen Mode ensures that the two I/Os cannot be activated at the same time.

Remember that when a screen control is configured, this will override the normal IO settings.

All commands start with: NEUNIT=<A>,SETTINGS=SCREEN,SCREEN= ,

Where <A> is the unit ID, default 1 and is the number of the screen you want to configure. All commands must end with a \CR.

Description:	Syntax	<X>	Default <X>	R/W						
Select the screen that should be configured	SCREEN=<X>	<table border="1"> <thead> <tr> <th><A></th> <th>R/W</th> </tr> </thead> <tbody> <tr> <td>1</td> <td>IO 1 and 2</td> </tr> <tr> <td>2</td> <td>IO 3 and 4</td> </tr> </tbody> </table>	<A>	R/W	1	IO 1 and 2	2	IO 3 and 4		W
<A>	R/W									
1	IO 1 and 2									
2	IO 3 and 4									
Enable or disable the screen mode	ENABLED=<X>	TRUE or FALSE	FALSE	R/W						
Delay time, pause time between the two outputs can be activated	BLOCK-TIME=<X>	0-6500.0 second	0	R/W						
Up time, The time it takes the screen to move from bottom to top of the screen.	UPTIME=<X>	0-6500.0 second	0	R/W						
Down time, The time it takes the screen to move from top to bottom of the screen	DOWNTIME=<X>	0-6500.0 second	0	R/W						

Examples of use:

- NEUNIT=1,SETTINGS=SCREEN,SCREEN=2,ENABLED =TRUE\CR <-Combine IO 3 and 4 on screen mode.
- NEUNIT=1,SETTINGS=SCREEN,SCREEN=2,UPTIME=35,DOWNTIME=30,BLOCKTIME=1.5\CR <-Set screen 2 to a uptime of 35 sec, a down time to 30 sec and a block time to 1,5 sec.

Screen control

The screen control will control the movement of the screen.

All commands start with: NEUNIT=<A>,SCREEN= ,

Where <A> is the unit ID, default 1 and is the number of the screen you want to control. All commands must end with a \CR.

Description:	Syntax	<X>	R/W
Control the screen either up, down or stop	ACTION=<X>	UP, DOWN, STOP	R/W

Example of use:

- NEUNIT=1,SCREEN=2,ACTION=UP\CR <- Raises screen 2 up in the time defined by the command "UPTIME" found in the "Screen control settings" section.
- NEUNIT=1,SCREEN=1,ACTION=STOP\CR <- Stops movement of screen 1.

LAN settings

The LAN settings commands are used to configure the LAN interface on the amplifier or preamplifier. Please remember to store the settings with the Save command if you want the unit to remember settings after a reboot.

All commands start with: NEUNIT=<A>,SETTINGS=LAN,

Where <A> is the unit ID, default 1. All commands must end with a \CR.

Description:	Syntax	<X>	Default <X>	R/W
Set unit IP address	IPAD-DRESS=<X>	xxx.xxx.xxx.xxx	192.168.254.252	R/W
Set unit sub net	SUBNET=<X>	xxx.xxx.xxx.xxx	255.255.255.0	R/W
Set gateway	GATEWAY=<X>	xxx.xxx.xxx.xxx	192.168.254.252	R/W
Select if DHCP is used or not.	DHCP=<X>	ON, OFF	OFF	R/W
LAN speed (F = Full duplex, H = Half duplex)	SPEED=<X>	10F, 10H, 100F, 100H, AUTO	100F	R/W
Set control TCP Port	IPPORT=<X>	0-65555	5000	R/W
Get the MAC address of the unit.	MACAD-DRESS=<X>	xx:xx:xx:xx:xx		R
Set the multicast address the unit must use when communicating with other Neets units by LAN. (Remember when changing this value, it must also be done on all other systems this unit must communicate with.) After changing the multicast address you must send the Save command to make sure that the system uses this address at next reboot.	MULTICASTAD-DRESS=<X>	xxx.xxx.xxx.xxx	224.10.10.25	R/W
Set the multicast port the unit must use when communicating with other Neets units by LAN. (Remember when changing this, it must also be done in all other systems this unit must communicate with.) After changing the multicast port, you must send the Save command to make sure that the system uses this port at next reboot.	MULTICAST-PORT=<X>	0-65555	7979	R/W

Example of use: NEUNIT=1,SETTINGS=LAN,IPADDRESS=192.168.10.2,SUBNET=255.255.255.0,GATEWAY=192.168.10.1\CR

RS-232 settings

The RS-232 settings commands are used to configure the RS-232 interfaces on the amplifier. Please remember to store the settings with the Save command if you want the unit to remember the settings after a reboot.

All commands start with: NEUNIT=<A>,SETTINGS=RS-232 , RS-232 = ,

Where <A> is the unit ID, default 1 and is the RS-232 number to control. All commands must end with a \CR.

Description:	Syntax	<X>	Default <X>	R/W
Set the comport baud rate	BAUDRATE=<X>	1200,2400,4800,9600,14400,19200,38400,57600,115200	0	R/W
Set the comport data bit	DATABIT=<X>	TRUE or FALSE	FALSE	R/W
Set the comport parity	PARITY=<X>	ON OR OFF	OFF	R/W
Set the comport stop bit	STOPBIT=<X>	-70 to -30	-50	R/W
Set the comport TCP Port number (if used as LAN gateway)	IPPORT=<X>	-70 to -30	-50	R/W

Example of use:

- NEUNIT=1,SETTINGS=RS-232 ,RS-232 =1,BAUDRATE=19200,DATABIT=7\CR <- Sets RS-232 port 1 to 19200 baud rate and 7 databit.
- NEUNIT=1,SETTINGS=RS-232 ,RS-232 =2,IPPORT=3570\CR <- Sets RS-232 port 2 IP port to 3570.

RS-232 control

The command below sends out a command on the RS-232 port.

For all commands the mandatory start sequence look like this: NEUNIT=<A>,RS-232 =

Where <A> as default is 1, and is the RS-232 port number to use. All commands must be started with a “,” and all lines must end with a \CR

Description:	Syntax	<X>	Default <X>	R/W
Data container. Each byte must be converted to a 2 byte ASCII value. Fx: “Neets” becomes “4E65657473”	DATA=<X>	Up to 500 bytes of data		R/W

Example of use: NEUNIT=1,RS-232 =2,DATA=4E65657473\CR - Sends “Neets” on RS-232 port 2

IR commands (Advanced users)

It is also possible to send IR codes on Tx 1 and 2. Sending IR codes is only possible when controlling the unit over LAN.

Before you start working with IR commands, it is important to understand that this part of the system is intended for advanced users and requires a high level of IR code knowledge.

The IR codes that are employed conform to a commonly used format. This allows you to easily find IR codes from other sources than Neets, e.g. www.remotecentral.com

If you want to control continuous functions such as volume on a device, you should remember to retransmit the IR command for as long as you want the volume to change. (Remember to wait for the acknowledgement of sending IR command before sending the next.)

Below are the settings for the IR. For all commands, the mandatory start sequence looks like this: NEUNIT=<A>,IR=

Where <A> as default is 1, and is the IR port number to use. All commands must be started with a “,” and all lines must end with a \CR

Description	Syntax	<X>	Default <X>	R/W
Data container. The data are in RAW IR code format. Can be copied directly from Neets Device Editor.	DATA=<X>	Up to 500 byte of data	xxxx yyyy zzzz	R/W

Example of use: NEUNIT=1,IR=2,DATA=0000 006D 0022 0002 0155 00AB 0015 0040 0016 0015 0015 0015 0016 0040 0015 0040 0016 003F 0016 0040 0015 0015 0016 0015 0016 0015 0015 0015 0016 0040 0015 0040 0016 0015 0015 0015 0016 0015 0016 0015 0015 0016 0015 0015 0015 0016 0015 0016 0015 0015 0016 0040 0015 0040 0016 003F 0016 0040 0015 0040 0016 003F 0016 0040 0015 05E9 0156 0055 0016 0E3F\CR <-Sending a IR command on the Tx 2 port.