

baby lock

Creative
COVER STITCH

Quick Reference Threading Guide

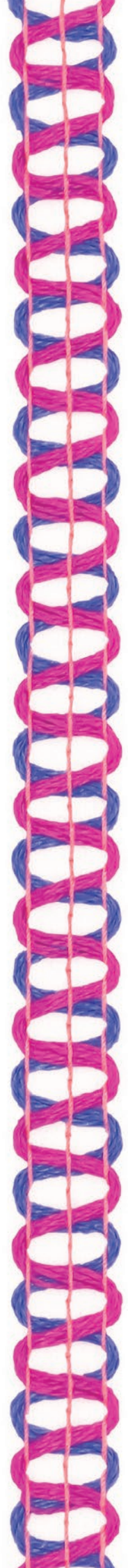

Wiper(s) Threading

step 1

Wiper Setting



QR Code for Threading Diagrams

Make sure steps for looper and needle(s) threading are completed and the threading lever is in serging position. For additional information or to review the threading diagrams see pages 21-24 in the instruction manual or scan the QR code.

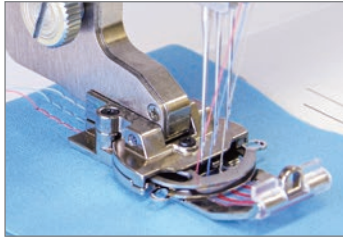

① Place a fabric leader under the presser foot and directly under the needle(s). Lower the presser foot lever and take a few stitches and trim the needle(s) thread(s).



② Make sure the "Wiper Positioning Lever" is in the "UP" position.



③ Position the needle(s) and wipers by using the "Needle Positioning Button".

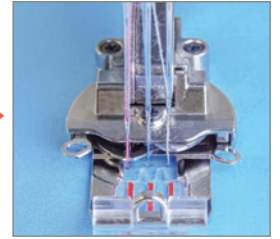

④ Make sure the needle(s) are in "UP" position and wipers are opened. Raise the presser foot.

step 2

Wiper Threading

Following the numeric sequence below when threading the wiper(s).

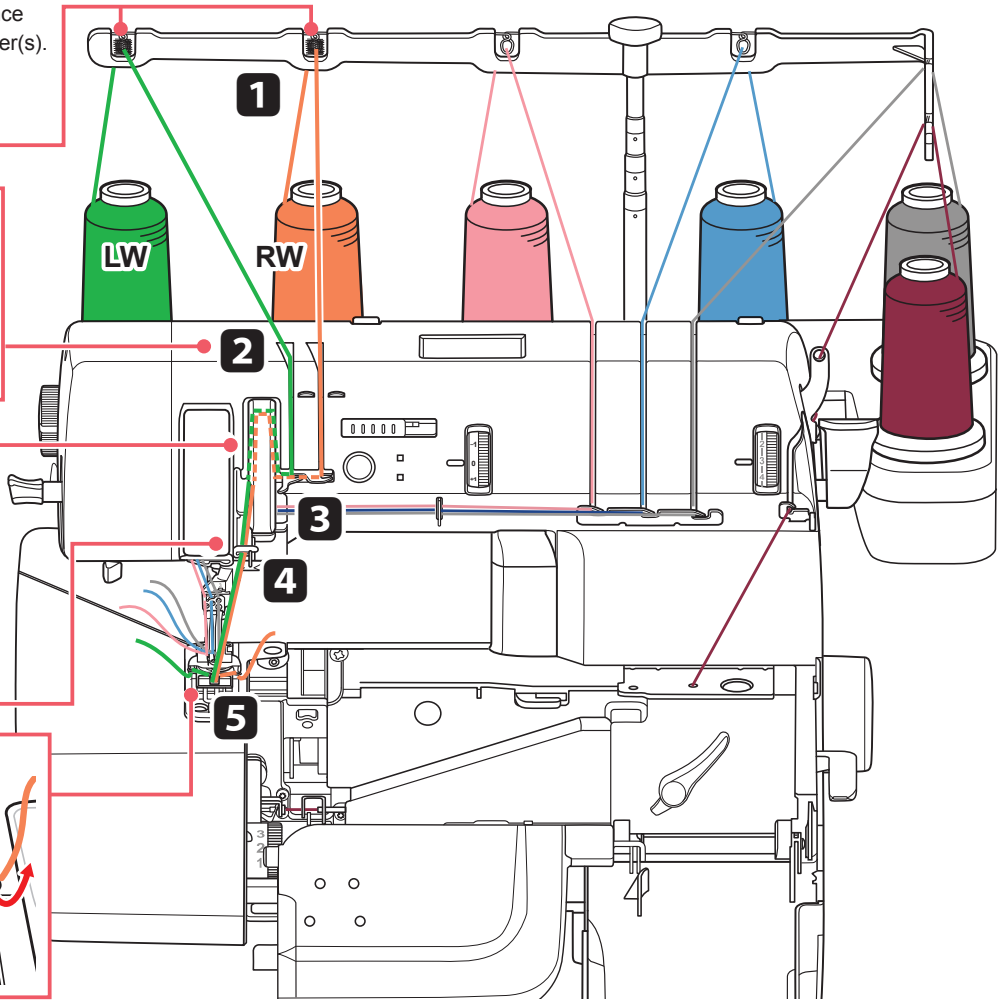
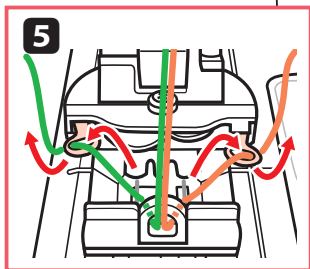
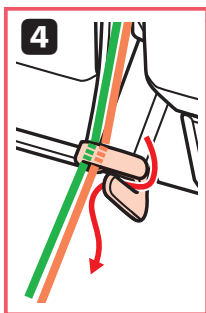
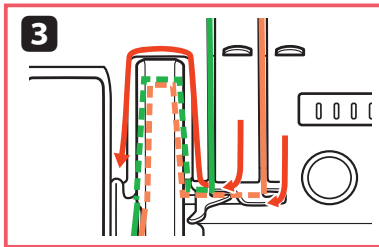
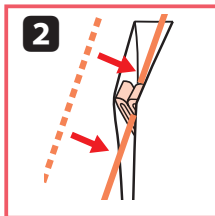
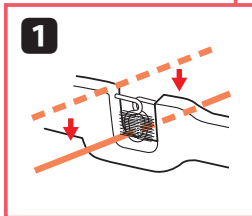

step 3

Start to Sew

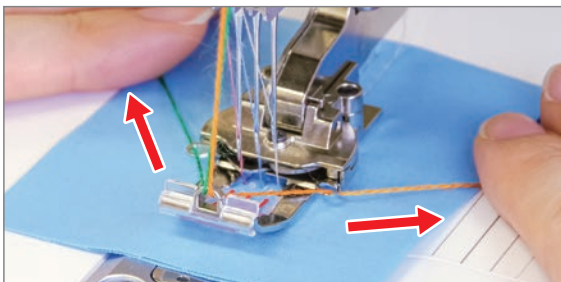

① Place the wiper thread(s) toward the back placing them in front of the needle(s). Holding onto the wiper thread(s) start stitching, slowly, on the leader.

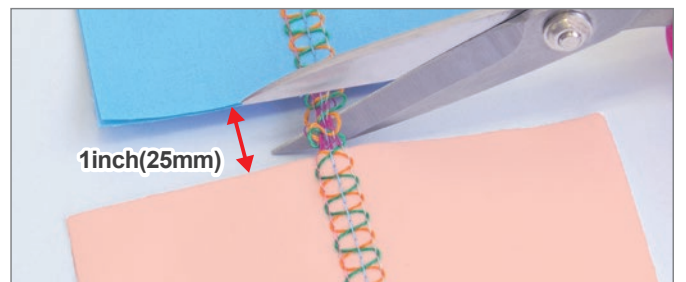

② After the first few stitches, stop and check the stitch. Is it forming correctly? Are the needle threads catching the wiper threads? Trim the wiper thread(s) close to the presser foot. Continue to sew on the leader and move to the fabric leaving about 1 inch (25mm) between the leader and the fabric. Trim the threads close to the leader.



Creative Top Cover Chain Stitch

Needle Position	Needle Tension	Chain Looper Tension	Stitch Length	Wiper Position Lever	Wiper Thread	Differential Feed
C1 or C2 or C3	AUTO (0)	2-3	3.0 - 4.0			N

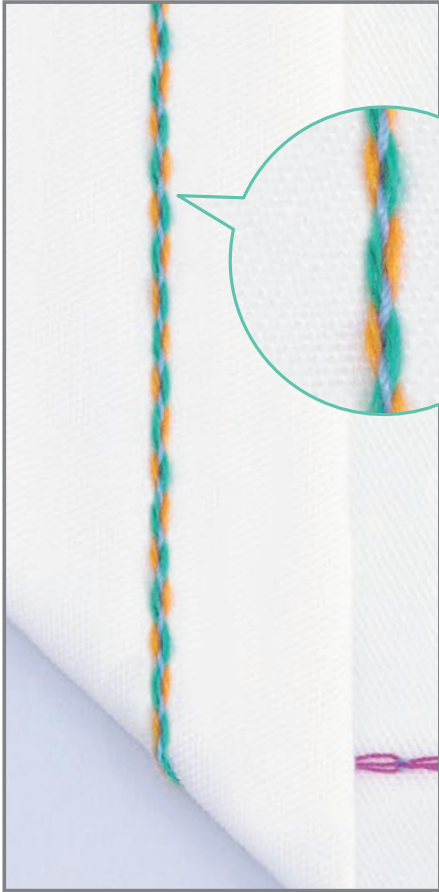

Needle C2

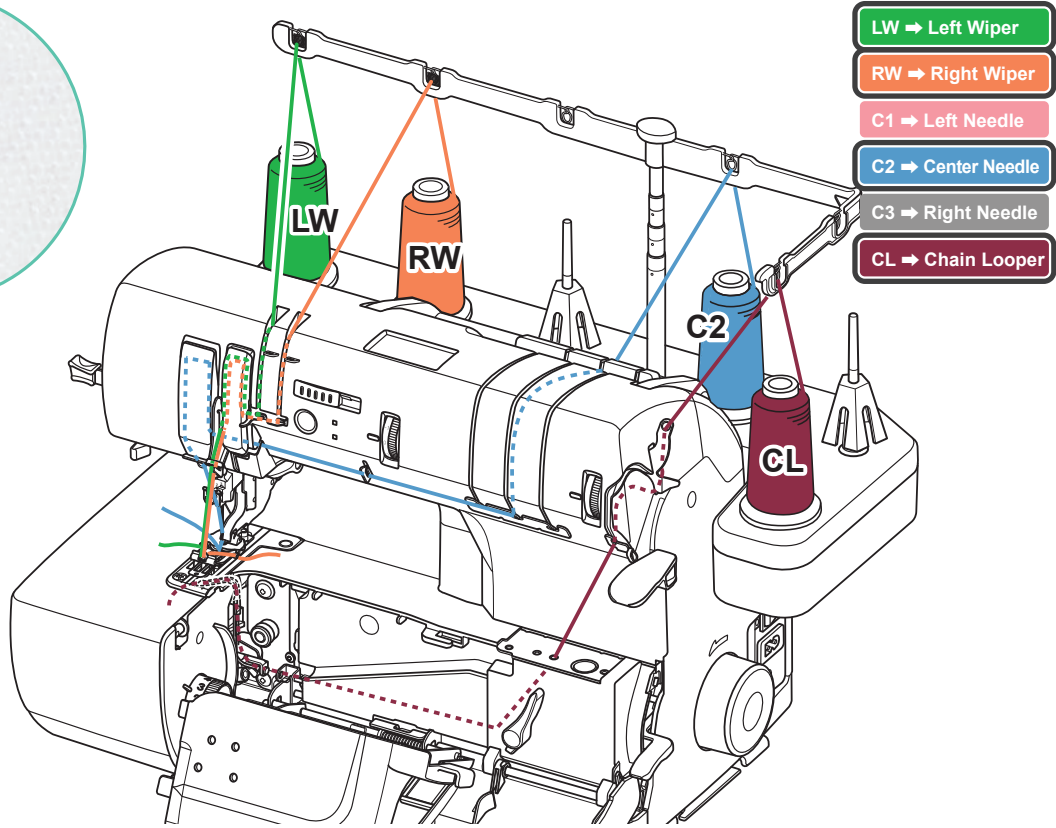

Creative Top Cover Stitch - Left (Right) Narrow 3mm

Needle Position	Needle Tension	Chain Looper Tension	Stitch Length	Wiper Position Lever	Wiper Thread	Differential Feed
C1 and C2 (Left) C2 and C3 (Right)	AUTO (0)	2-3	3.0 - 4.0			N

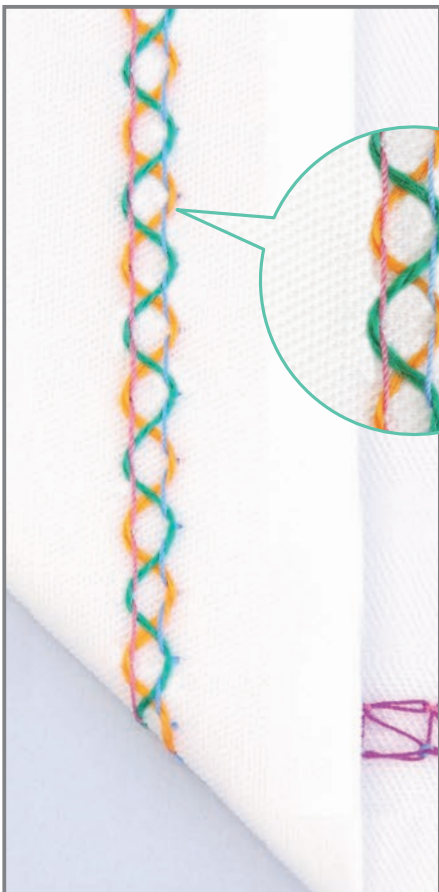

Needle C1, C2

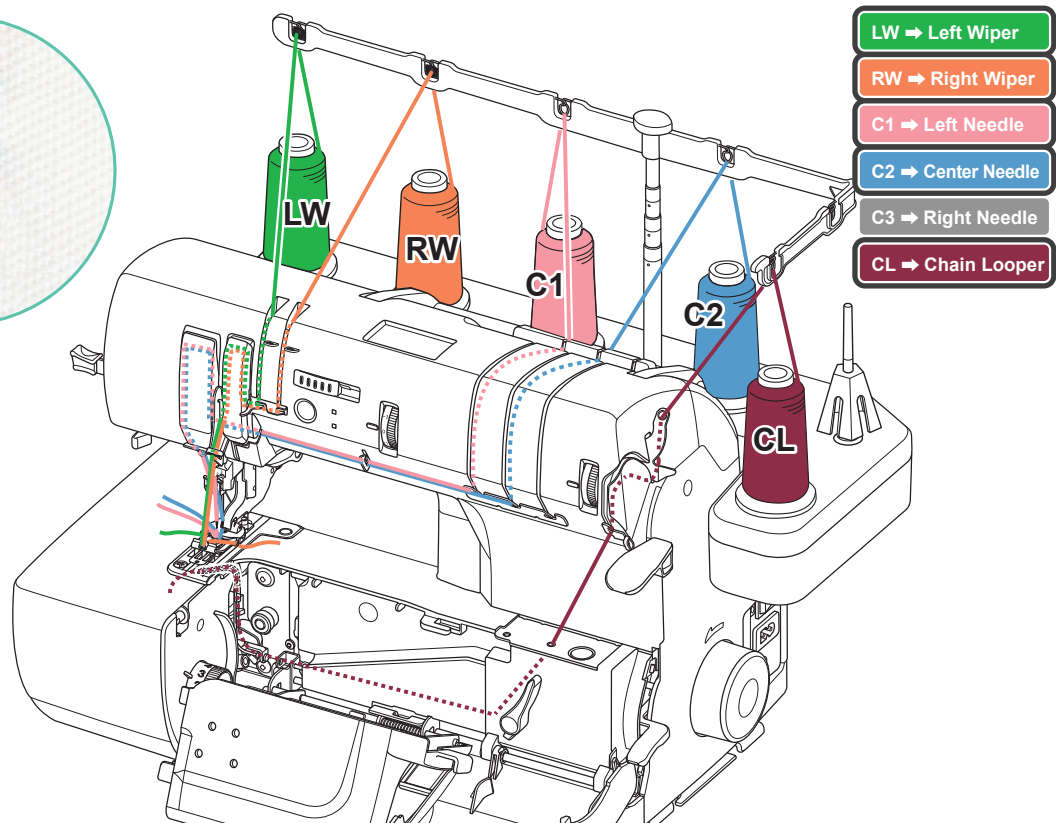



Creative Top Cover Stitch - Wide 6mm



Needle C1, C3

Needle Position	Needle Tension	Chain Looper Tension	Stitch Length	Wiper Position Lever	Wiper Thread	Differential Feed
C1 and C3	AUTO (0)	2-3	3.0 - 4.0			N

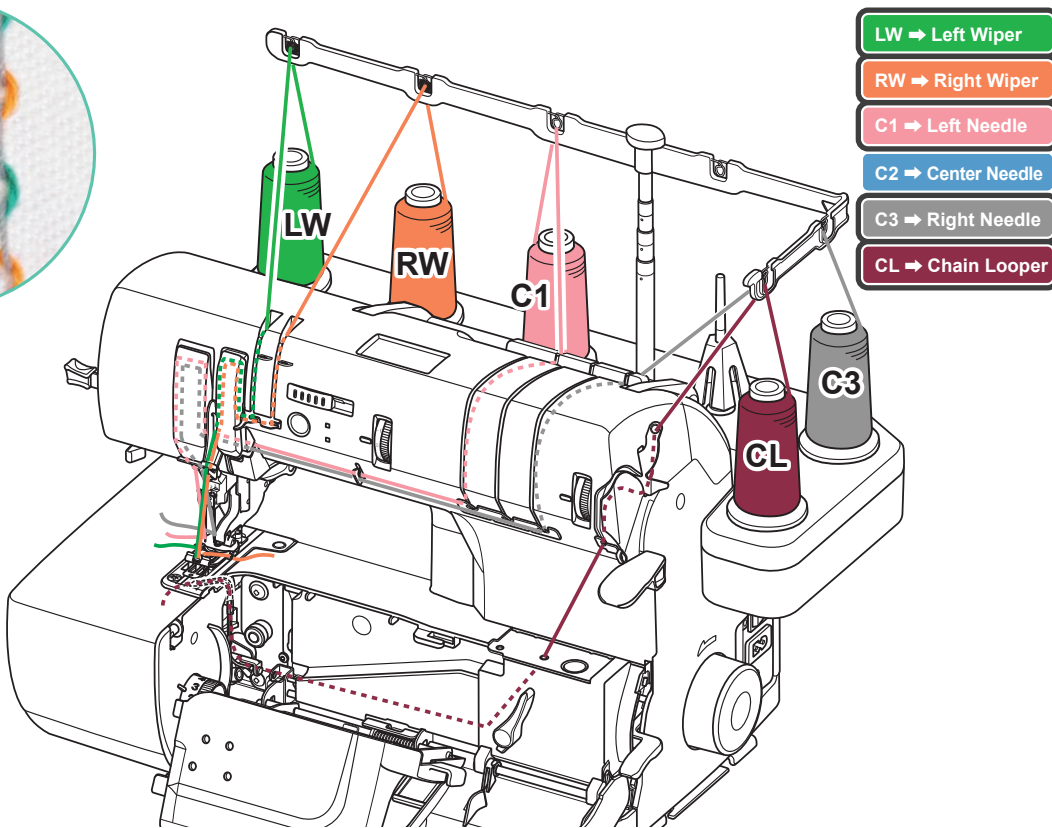

Creative Top Cover Triple Stitch 6mm

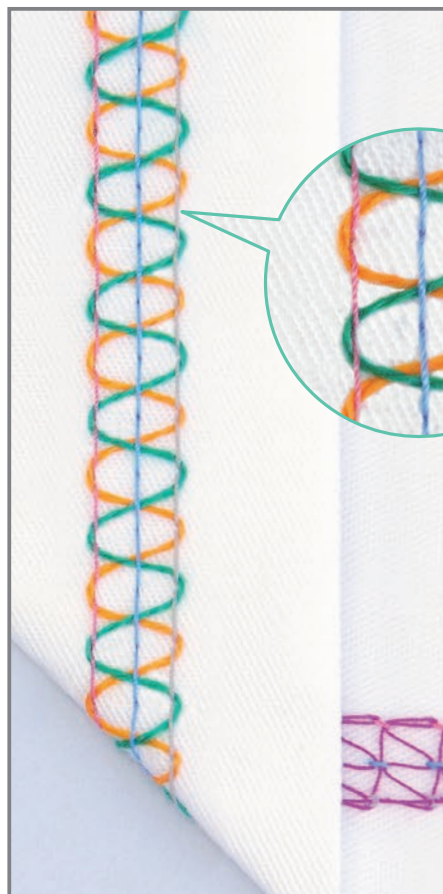

Needle C1, C2 and C3

Needle Position	Needle Tension	Chain Looper Tension	Stitch Length	Wiper Position Lever	Wiper Thread	Differential Feed
C1, C2 and C3	AUTO (0)	2-3	3.0 - 4.0			N

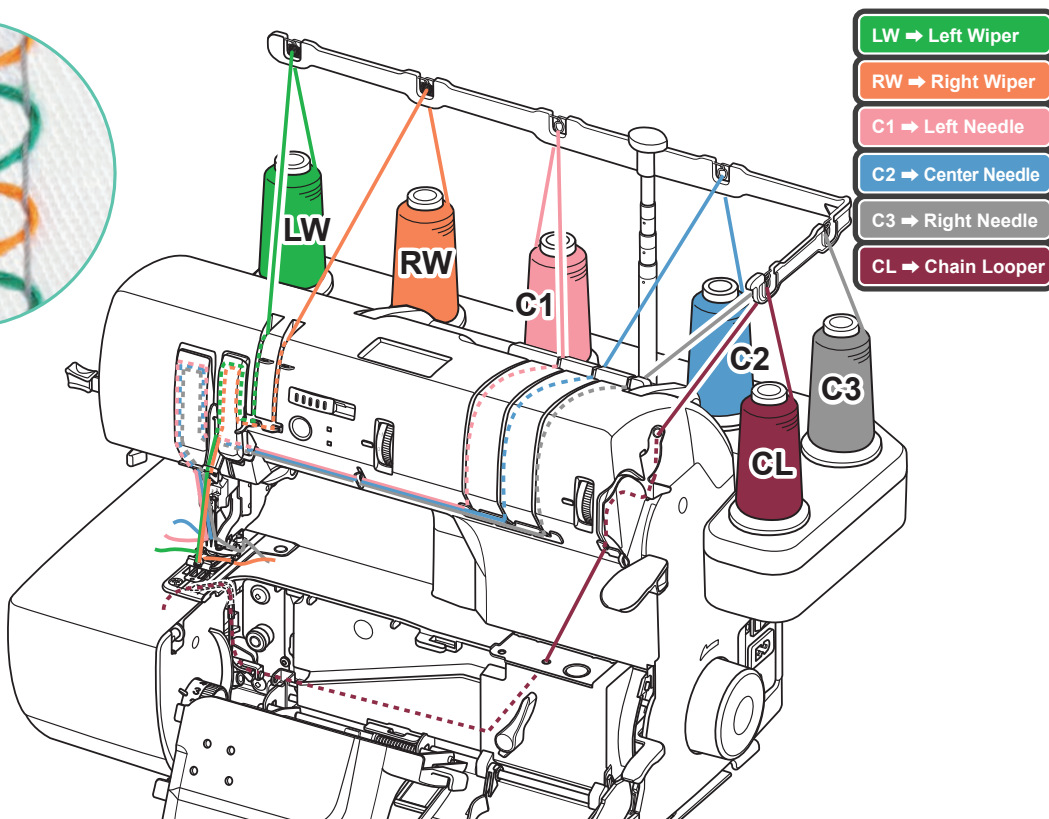



Creative Top Cover Chain Stitch / One Wiper



Needle C2
Left Wiper

Needle Position	Needle Tension	Chain Looper Tension	Stitch Length	Wiper Position Lever	Wiper Thread	Differential Feed
C1 or C2 or C3	AUTO (0)	2-3	3.0 - 4.0			N

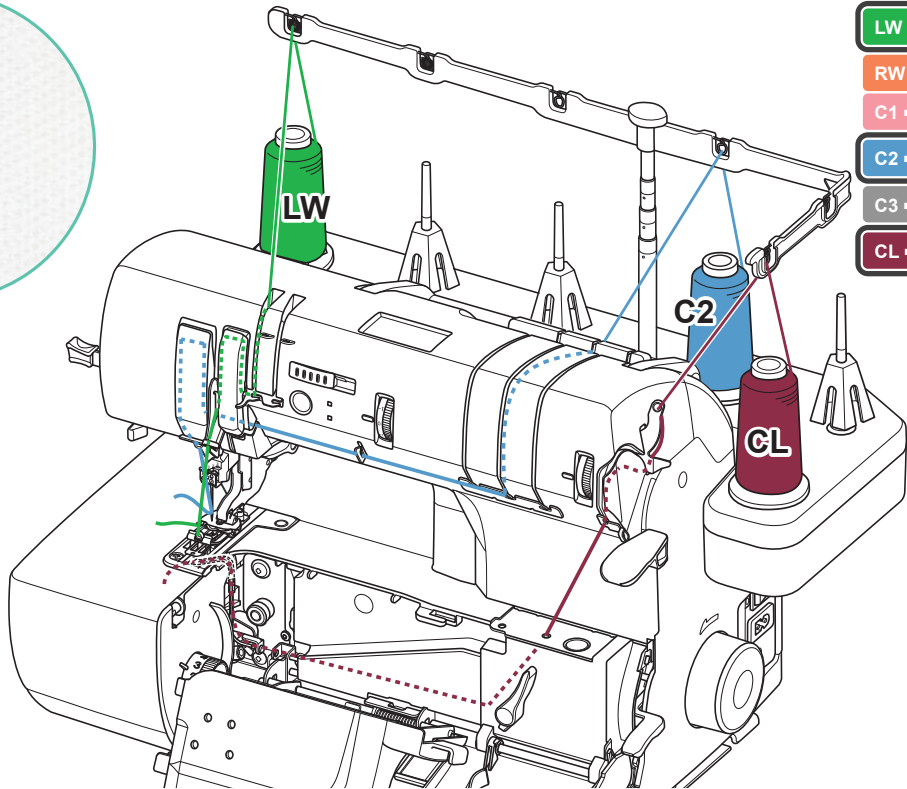

- LW → Left Wiper
- RW → Right Wiper
- C1 → Left Needle
- C2 → Center Needle
- C3 → Right Needle
- CL → Chain Looper

NOTE: When using the Right Wiper follow the same threading path as the Left using the guides for the Right Wiper.

Creative Top Cover Stitch - Left(Right) Narrow 3mm / One Wiper



Needle C1, C2
Left Wiper

Needle Position	Needle Tension	Chain Looper Tension	Stitch Length	Wiper Position Lever	Wiper Thread	Differential Feed
C1 and C2 (Left) C2 and C3 (Right)	AUTO (0)	2-3	3.0 - 4.0			N

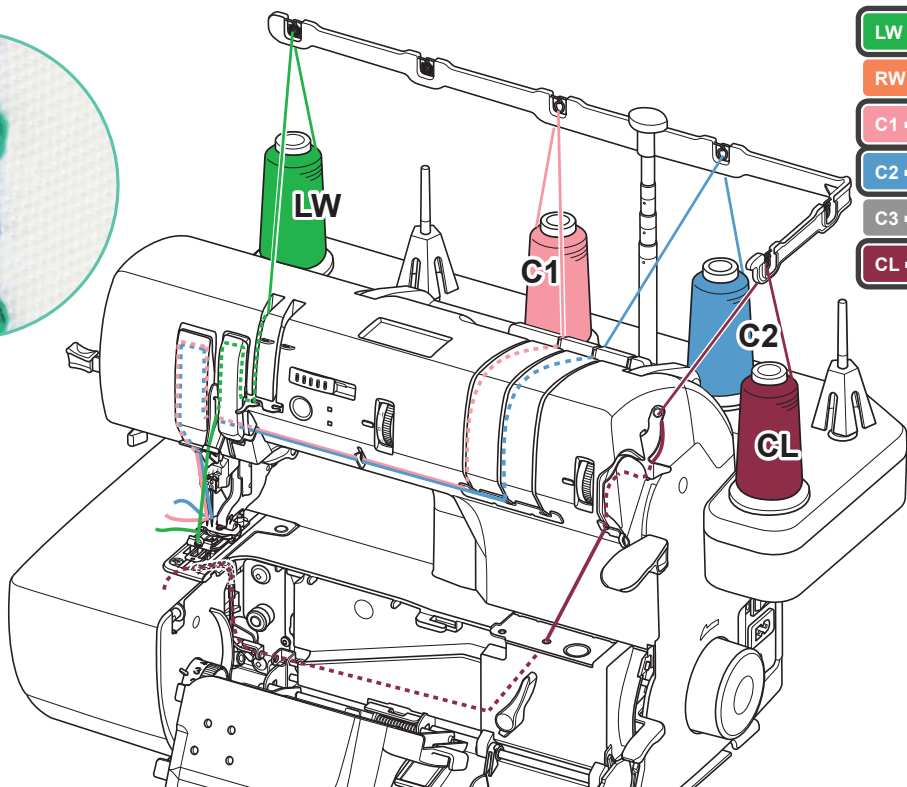

- LW → Left Wiper
- RW → Right Wiper
- C1 → Left Needle
- C2 → Center Needle
- C3 → Right Needle
- CL → Chain Looper

NOTE: When using the Right Wiper follow the same threading path as the Left using the guides for the Right Wiper.

Creative Top Cover Stitch



One Wiper

Creative Top Cover Stitch - Wide 6mm / One Wiper



Needle C1, C3
Left Wiper

Needle Position	Needle Tension	Chain Looper Tension	Stitch Length	Wiper Position Lever	Wiper Thread	Differential Feed
C1 and C3	AUTO (0)	2-3	3.0 - 4.0			N

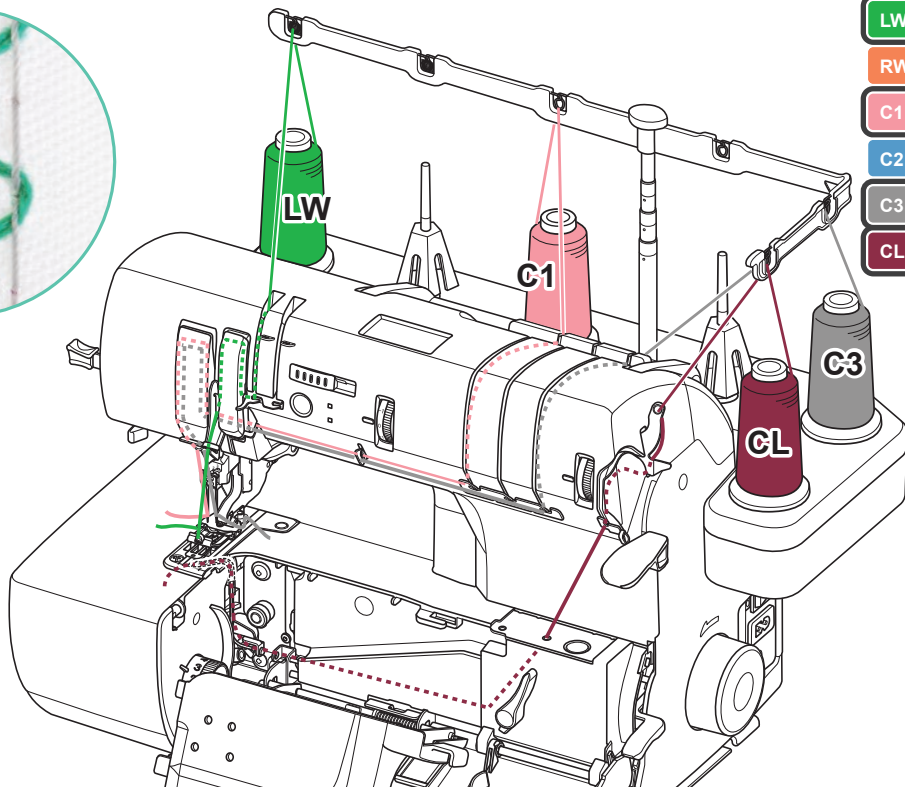

- LW** → Left Wiper
- RW** → Right Wiper
- C1** → Left Needle
- C2** → Center Needle
- C3** → Right Needle
- CL** → Chain Looper

NOTE: When using the Right Wiper follow the same threading path as the Left using the guides for the Right Wiper.

Creative Top Cover Triple Stitch 6mm / One Wiper

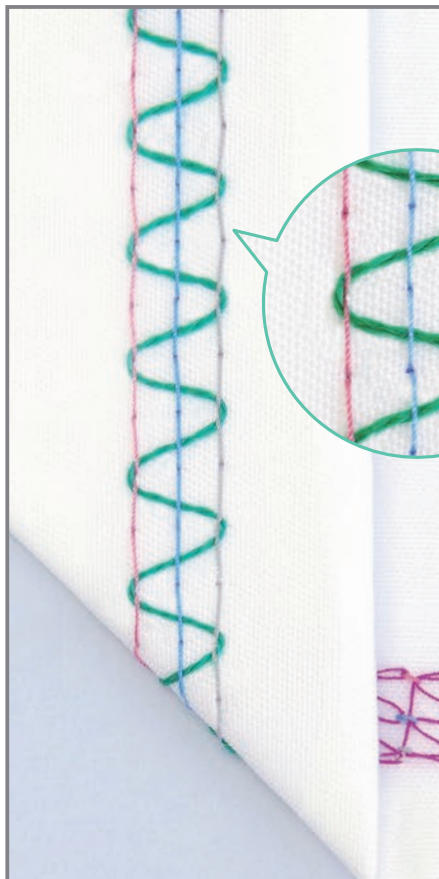

Needle C1, C2 and C3
Left Wiper

Needle Position	Needle Tension	Chain Looper Tension	Stitch Length	Wiper Position Lever	Wiper Thread	Differential Feed
C1, C2 and C3	AUTO (0)	2-3	3.0 - 4.0			N

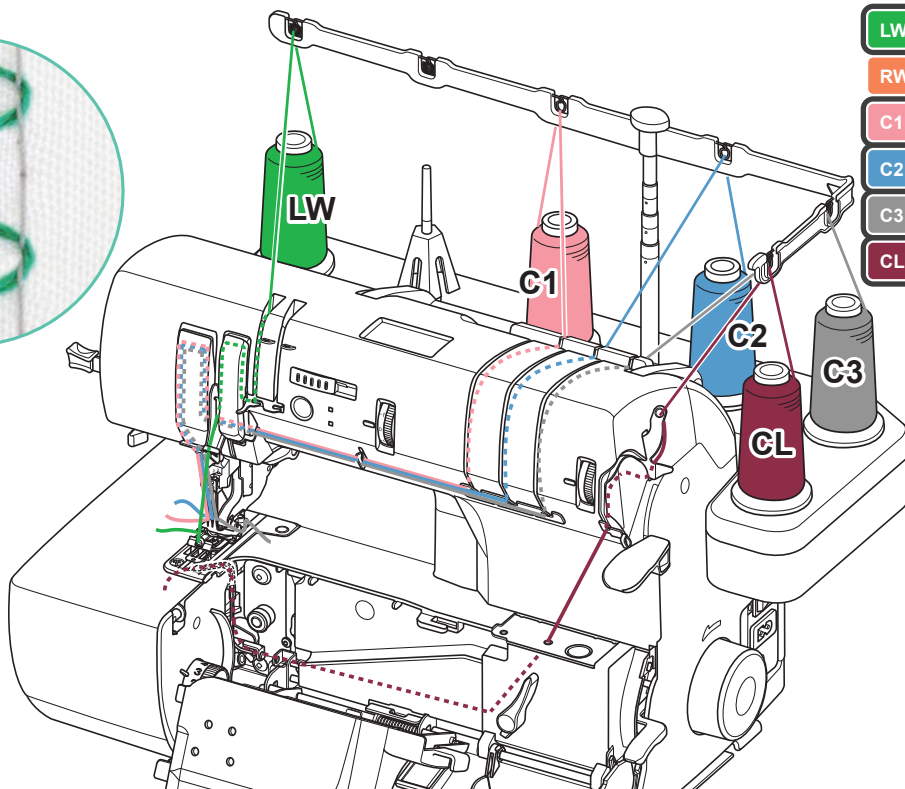

- LW** → Left Wiper
- RW** → Right Wiper
- C1** → Left Needle
- C2** → Center Needle
- C3** → Right Needle
- CL** → Chain Looper

NOTE: When using the Right Wiper follow the same threading path as the Left using the guides for the Right Wiper.