

Diesella



18562500

User/Technical Manual

Contents subject to change without notice

Version 1.1
11/2018

TABLE OF CONTENTS

General and Safety Information	1
Specifications	2
Connection types.....	2
1. INSTALLATION	3
Contents.....	3
Unpacking and Installation.....	3
2. OVERVIEW OF CONTROLS AND FUNCTIONS	5
Indicator Display Character Definitions	5
Indicator Display	6
Function Keys.....	7
3. Operation Menu Structure	8
Enter Setup Mode.....	8
CONFIG Submenu:.....	8
USER Submenu:	12
CAL Submenu:	17
MISC Submenu	18
TEST Submenu	18
4. OPERATIONS.....	19
Change working mode.....	19
Normal Weighing Mode.....	19
ZERO.....	20
Setting a Tare Weight	20
Setting a Pre-Determined Tare Weight	20
Check Weighing (Data Compare) in Normal Weighing Mode.....	21
Accumulation Mode	21
Counting Mode	22
Check Counts (counts compare) in Counting mode:.....	23
Percent Weighing Mode	24
Check Percent (percentage compare) in Percent weighing mode:	25
BMI Working Mode (closed on ECS-B)	26
Weight Fine-tune (closed on ECS-B).....	26
HOLD Function	27
Details about Serial Communication	29
5. Calibration	35
6. MISC	39
View ADC output Code.....	39
View or Calibrate Power Voltage	39
View or Set Date	40
View or Set Time	40
View Firmware Version	40
7. TEST	41
Display Test	41
Serial Port1/2(COM1/2) Transmitting Test	41
Keyboard and Buzzer Test.....	41
8. Connectors and Jumpers	42
9. Definitions	44
10. Troubleshooting	45

INTRODUCTION

General and Safety Information



- Risk of Electrical Shock: Disconnect all power sources before making cable connections to the floor scale platform or indicator.

- For use in dry environments only.



- The floor scale platform is very heavy. Use appropriate lift equipment.

- Scale platform must be installed on a foundation capable of safely supporting the weight of the floor scale plus the weight of the maximum load.

- Do not operate in hazardous areas.

- Read and understand all operating instructions before using this product keep this manual for future reference.
- Record the weight shortly after placing a load on the platform. After extended periods, the load cell's output signal may result in a less accurate reading.
- Avoid extended exposure to extreme heat or cold. Optimum operation is at normal room temperature. See operating temperature range in the specifications table. Allow the scale to acclimate to room temperature before using.
- Allow sufficient warm up time. Turn the scale on and allow up to 2 minutes for internal components to stabilize before weighing.
- Electronic scales are precision instruments. Do not operate near cell phones, radios, computers or other electronic devices that emit radio frequencies that may cause unstable readings.
- This equipment has been tested and found to comply with the limits for a Class A digital device, pursuant to Part 15 of the FCC Rules. These limits are designed to provide reasonable protection against harmful interference when the equipment is operated in a commercial environment. This equipment generates, uses, and can radiate radio frequency energy and, if not installed and used in accordance with this manual, may cause harmful interference to radio communications. Operation of this equipment in a residential area is likely to cause harmful interference, in which case the user will be required to correct the interference at his own expense.
- Avoid using in heavy vibration or heavy airflow conditions. This also applies when the floor scale is integrated into conveying systems.

Specifications

Model	18562500
Max Capacity	3000kg (6000lb)
Readability	0.5kg (1lb)
Display Resolution	1:6000
Min Recommended Weight	10kg / 20lb
Construction	Epoxy painted carbon steel, treaded surface, 1/8" fixed top plate
Weighing Units	Kg / lb / lb:oz
Calibration unit	kg
Application Modes	Weighing, Counting, Check weighing,
Display	6 1/2-digit, 7-segment, 1" (25mm) LCD with backlight
Zero Range	Programmable zero range
Tare Range	Full capacity
Stabilization Time	<3 seconds
Operating Temperature	15° to 105°F (-10° to 40°C)
Humidity Range	<90% relative humidity, non-condensing
Power supply	Alkaline Batteries: 4 x "AA" size cells AC Adapter: 9Vdc/600mA, with central positive 
Interface	RS232 (COM1) and USB (COM2)
Feet	4 x fixed bolt design, adjustable height
Safe Max Overload	150% of capacity
Platform Dimensions (L x W x H)	1200x1200x105mm / 48" x 48" x 4.15"
Gross weight	90.5kg / 199lb

Connection types

7 pins socket used:

Pin1: Excitation +

Pin2: Sense +

Pin3: Signal +

Pin4: Excitation -

Pin5: Sense -

Pin6: Signal -

Pin7: Shield

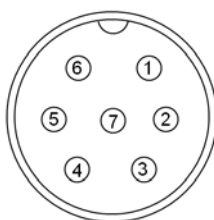

(7 holes socket)
Indicator

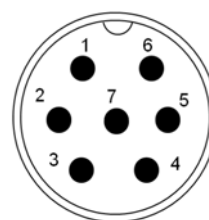

(7 pins socket)
Base

1. INSTALLATION

Contents

- Indicator
- Cable from platform to indicator
- Technical Manual
- Scale platform
- DC9V 600mA adapter

Unpacking and Installation

1. Remove the indicator and AC adapter from inside of the box show below.

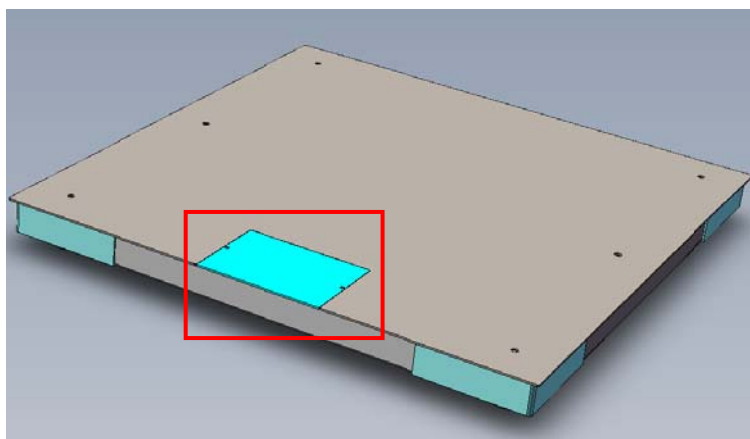

2. Loosen the 4 feet by turning the feet counter clockwise.

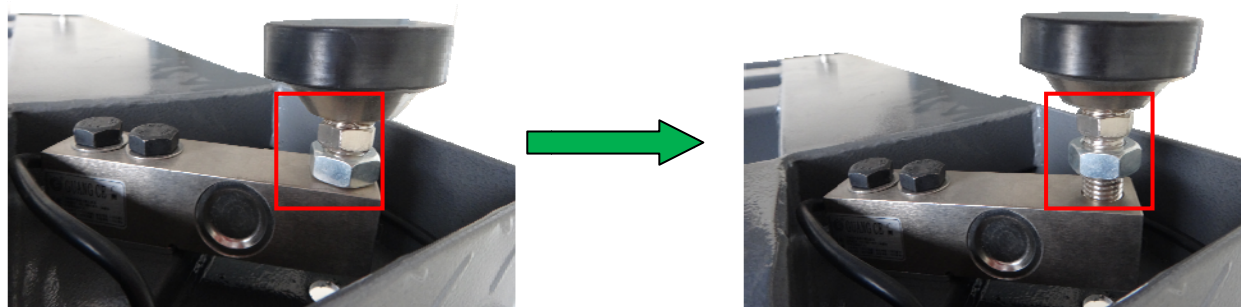

3. Turn the scale base right side up, use a screwdriver to adjust the feet to level the scale, then fasten the locknut to the loadcell.

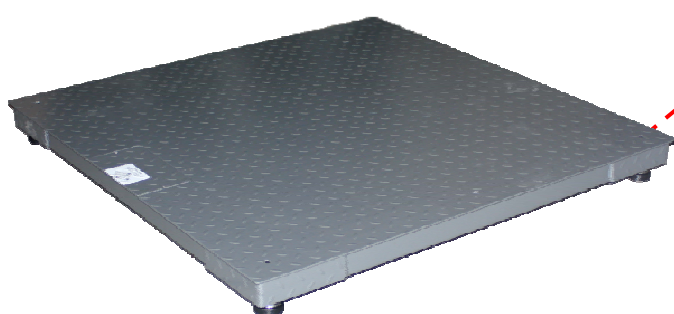

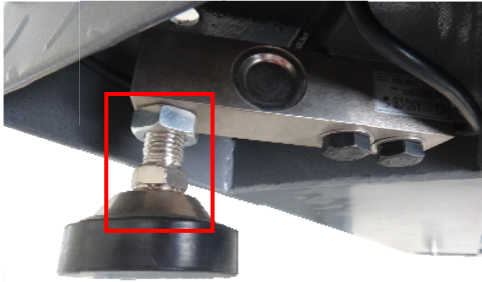

4. Open the cover of the junction box compartment and remove the cable. Run the cable through the hole and connect the connector of the cable to the connector of the indicator.

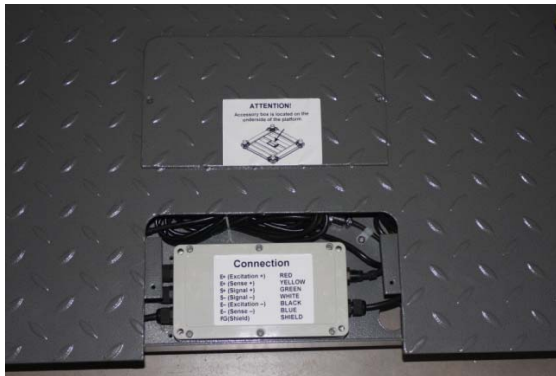





































5. Put the cover back on, tighten the two screws, then install the batteries or plug in the adapter. Now the scale is ready for use.



2. OVERVIEW OF CONTROLS AND FUNCTIONS

Indicator Display Character Definitions

ASCII	LCD/LED Show	ASCII	LCD/LED Show	ASCII	LCD/LED Show
0		A		N	
1		B		O	
2		C		P	
3		D		Q	
4		E		R	
5		F		S	
6		G		T	
7		H		U	
8		I		V	
9		J		W	
		K		X	
		L		Y	
		M		Z	

Indicator Display

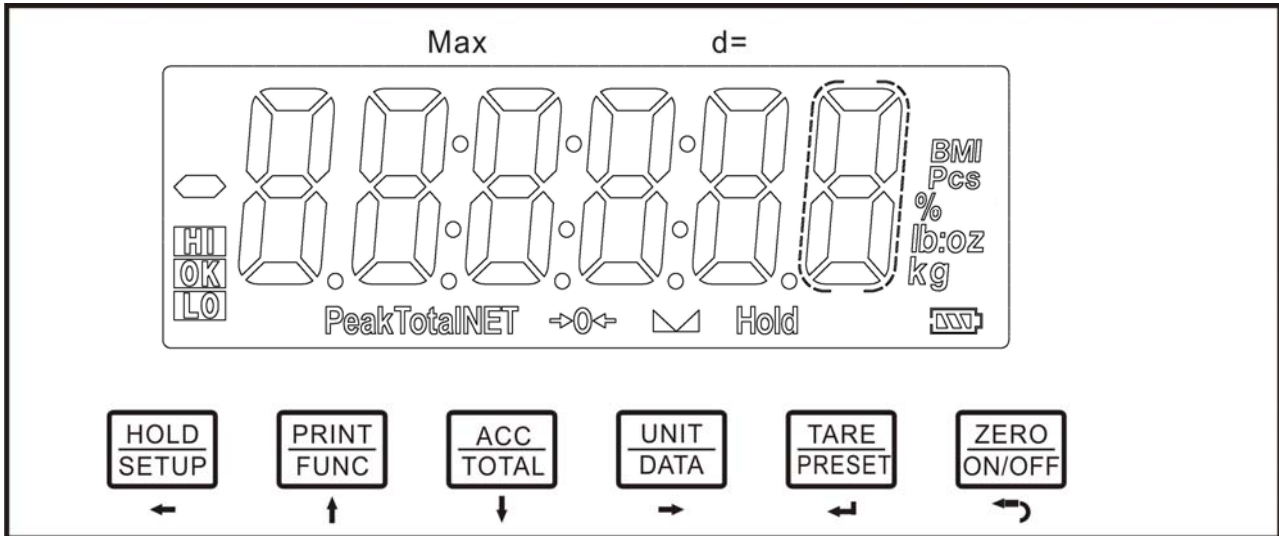







- $\rightarrow 0 \leftarrow$ - Scale is zeroed, gross weight is 0, tare is 0.
- \blacktriangle - Scale is stable.
- **NET** - Display reading is net weight; tare is not 0.
- **Total** - Display data is accumulated total times, weight, pieces, or percentage.
- **Hold** - Scale is in dynamic weighing mode.
 - **Hold** flashes - actual fluctuating weight displayed.
 - **Hold** does not flash - locked weight is displayed.
- **Peak** - Scale is in dynamic weighing mode. Hold type is PEAK-HOLD.

- **lb** - Measure unit is lb or lb:oz
- **oz** - Measure unit is oz or lb:oz
- **kg** - Measure unit is kg
- **%** - Measure unit is % (in percentage weighing mode).
- **Pcs** - Measure unit is pieces (in counting mode).
- [Battery Icon] - Battery level.

- **HI** - Data compare (check-weighing) is enabled. Current data (weight, pieces, or percent) is above the specified upper limit.
- **OK** - Data compare is enabled. Current data is between the specified upper and lower limits.
- **LO** - Data compare is enabled. Current data is below the specified lower limit.

Function Keys

KEY	MODE		DEFINITION
	Weighing, Counting, or Percent mode	<3 seconds	Enters or exits HOLD mode
		>3 seconds	Enters SETUP mode
	Input data mode	<3 seconds	Returns to last sub-menu
		>3 seconds	Inputs decimal point
	Menu selection mode		Returns to last sub-menu
	Weighing, Counting, or Percent mode	<3 seconds	Sends output data via the serial port
		>3 seconds	Selects mode: Weighing, Counting, or Percent
	Input data mode		Increases the digit in the flashing data entry position by one
	Menu selection mode		Returns to last item of current sub-menu
	Weighing, Counting, or Percent mode	<3 seconds	Adds accumulation values to memory; displays instances and totals
		>3 seconds	Displays accumulation instances and totals
	Input data mode		Decreases the digit in the flashing data entry position by 1
	Menu selection mode		Goes to next item of current sub-menu
	Weighing mode	<3 seconds	Changes weighing unit of measure
	Counting or Percent mode	<3 seconds	Enters the submenu to input piece weight for counting or to enter reference weight for percent-weighing
	Weighing, Counting, or Percent mode	>3 seconds	Enters the submenu to input the comparative data range for check-weighing
	Time or Date mode	>3 seconds	Enters time or date setting mode
	Input data mode		Shifts the flashing data entry position from right to left
	Menu selection mode		Goes to next item of current sub-menu
	Weighing, Counting, or Percent mode	<3 seconds	Tare the weight
		>3 seconds	Enters pre-determined tare input mode
	Input data mode		Confirms the input data and forwards to next step
	Menu selection mode		Confirms the input data and forwards to next step
	Power Off		Powers on
	Weighing, Counting, or Percent mode	<3 seconds	Zeros the platform weight
		>3 seconds	Powers off
	Input data mode		Ignores the modification
	Menu selection mode		Exits from current working mode

Note: Normally, the second function of a key will need to be pressed for more than 3 seconds to be activated.

3. Operation Menu Structure

Enter Setup Mode

1. If there is a need to: configure parameters, set user parameters, calibrate the scale, set current date or time, test some hardware, press the **HOLD/SETUP** until entered into setup mode
2. After entering into setup mode, the main menu item **CONFIG** will be shown.
3. In Setup mode, use ← ↑ ↓ key to select the main menu item, then press the **TARE/PRESET** key to enter the item; use ← ↑ ↓ → ← ↵ ↵ key to select the submenu item, to select a choice, to set a number, to confirm and save data, and/or to exit this mode.
4. Main menu



CONFIG Submenu:

CONFIG				
SubMenu1	SubMenu2	Option	Remark	18562500 Setting
CFG.ON CFG.OFF			Seal switch is on or off	ON
RESET		NO	Reset configure parameters to factory setting	NO
		YES		
REGULAR		NONE	Select the standard that the scale will comply with: USA,CANADA, EUROPE	NONE
		USA		
		CANADA		
		EUROPE		
Pr. n.		100- 100000	The division number under primary unit, if (REGULAR)≠none, the max is 10,000	6000
Pr. n.d		0.0001	The division value under primary unit; the division value under second unit is automatically determined by indicator according to the division value under primary unit.	0.5
		0.0002		
		0.0005		
		0.001		
		0.002		
		0.005		
		0.01		
		0.02		
		0.05		
		0.1		
		0.2		
		0.5		
		1		
		2		
		5		
10				
20				
50				

SubMenu1	SubMenu2	Option	Remark	18562500 Setting
Pr i n t		KG	Select the primary unit from kg or lb; defaulted calibration standard weight unit is the primary unit.	KG
		Lb		
5ECND.N		100-125000	The division number under second unit, the max is 1.25*(PRIM.N). if(REGULAR)≠none, the max is 10,000	6000
10N.dSP		NO	Display weight at 10 times division number under primary unit. if (REGULAR)=none, no this item	N.A
		YES		
h o t i o n		1-255	Check motion window: 1-255=±0.25d *(1-255), if (REGULAR)≠none, the max is 12	4
o v e r L d		0- 100	Over load display limitation: 0=FS+9d; 1-100=101%FS -200%FS, if (REGULAR)≠none, the max is 10	0
Ad.Fro n		AdC	Data of ADC comes from: ADC=local A/D chip on PCB; COM3=COM3 interface;	AdC
		[o n]		
Ad.H.SPd		NO	Speed of A/D convert: NO=10Hz; YES=80Hz; if AD.FROM=COM3,this item will not be shown	NO
		YES		
U N I T S	KG	YES	Units that can be used by UNIT key select: YES=enable this unit to be used; NO=disable this unit to be used; Refer to table5-1 and table5-2. For legal-for-trade application, lb:oz is not allowed.	YES
		NO		YES
	Lb	YES		YES
		NO		NO
	o z	YES		YES
		NO		NO
	Lb o z	YES		YES
		NO		NO
G	YES	NO		
		NO		
Z r o P N t	i n i z s n	0- 100	Initial zero(power on zero) point range: 0=no limitation; 1-100= (calibration zero point) ±1%FS ~(calibration zero point) ±100%FS, If (REGULAR)≠none, the max is 10	100
		CAL.ZRO	Choose which weight as current initial zero point when current weight is in IZSM range: WEIGHT= current weight ; CAL.ZRO= calibration zero; LAST.Z.T=switch-off zero and tare If (REGULAR)≠none, the value is fixed on WEIGHT	WEIGHT

SubMenu1	SubMenu2	Option	Remark	18562500 Setting
Zero.Pnt	oū.iēēñ	dSP.oūr	Choose which weight as current initial zero point when current weight is <u>over</u> IZSM range: DSP.OVR=display initial zero is over; WEIGHT= current weight; CAL.ZRO= calibration zero; LAST.Z.T=switch-off zero and tare If (REGULAR)≠none, the value is fixed on DSP.OVR	dSP.oūr
		ŸE, GHt		
		CAL.ērō		
		LAST.ēt		
	ŸAēēñ	0-100	Zero key range: 0=no limitation; 1-100= (initial zero point) ±1%FS~(initial zero point) ±100%FS, if (REGULAR)≠none, the max is 2	2
	Aēēñ	0-100	Zero tracking window: 0=0d, no tracking; 1-100=±(0.2+0.05*(1-100))d /s, if (REGULAR)≠none, the max is 10	56
Filter	FLt 1.tH	0-255	Enter digital filter1 threshold: 0=no filter1; 1-254=filter1 be used only when vibration in ±0.25d*(1-254) ; 255= filter1 be always used	40
		1-64	Digital filter1 intensity: 1-64 ADC's data will be averaged	8
	FLt 2.tH	0-255	Enter digital filter2 threshold: 0=no filter2; 1-254=filter2 be used only when vibration in ±0.25d*(1-254) ; 255= filter2 be always used	8
		0-255	Digital filter2 intensity: 0-255=weak to strong	240
FUNC	HoLd	ŸEē	Yes/No=enable/disable hold function; In trade application HOLD function should be prohibited	ŸEē
		no		
	CoUNT	ŸEē	Yes/No=enable/disable counting function.	ŸEē
		no		
	PErCt	no	Percent weighing function is enable or disable: NO=disable; 100%=enable and display format is 100% ; 100.0%=enable and display format is 100.0%; 100.00%=enable and display format is 100.00%;	100.0%
		100%		
		100.0%		
		100.00%		
bñi	ŸEē	Yes/No=enable/disable BMI function,	no	
	no			

SubMenu1	SubMenu2	Option	Remark	18562500 Setting
FUNC	COPAR	YES	Yes/No=enable/disable data comparison function;	YES
		NO		
	ACCU	NO	Accumulation Mode selection: NO=no accumulation function; MANUAL=add up current number to accumulation memory after TATOL key is pressed; AUTO=automatically add up current number to accumulation memory after scale is stable and weight is over (NLD.RNG)	MANUAL
		MANUAL		
		AUTO		
	GEOCAL	YES	Yes/No=enable/disable Geographical Adjustment Factor	YES
		NO		
	WEADJ	YES	Yes/No=enable/disable weight fine-tuning using keypad in weighing mode, if (REGULAR)≠none, this item is N.A.	NO
NO				

* The setting will be limited by choice of REGUALA



CONFIG settings should only be performed by individuals with the required technical knowledge.

USER Submenu:

USER				
Sub-Menu1	Sub-Menu2	Option	Remark	18562500 Setting
rESEt	no	no	Reset user parameters to factory setting	no
	YES			
Com1	bAUDrE	1200	Selection of com1's baud rate	9600
		2400		
		4800		
		9600		
		19200		
		38400		
	bYTEFmE	8N1	Selection of com1's byte format: 8N1=8 data bits, No parity check bit, 1 stop bit; 7O1=7 data bits, 1 Odd parity check bit, 1 stop bit; 7E1=7 data bits, 1 Even parity check bit, 1 stop bit; 7O2=7 data bits, 1 Odd parity check bit, 2 stop bit; 7E2=7 data bits, 1 Even parity check bit, 2 stop bit;	8N1
		7O1		
		7E1		
		7O2		
		7E2		
	oUT.mod	noNE	Selection com1 output mode: NONE =No communication; CONT=continuously output; PRINT=output after PRINT key pressed; CMD=output after a request command is received; PRT.CMD= output after PRINT key pressed or request command received; STABLE=output after scale is stable; Note: use PRINT or CMD to output data, the scale must	CoNE
		CoNE		
		Pr,NE		
		Cnd		
		PrECoNd		
StABLE				
LAYoUT	noULTPL	Com1 output content and format set: MULTPL= the following selected item in OUT1 will be output use defined format; SINGLE= only displayed content and current status will be output, it's compatible with NCI-SCP01; EH-SCP= Command –response mode; SCP-12= only displayed content and current status will be output, it's compatible with NCI-SCP12(NCI3835);	S,NGLE	
	S,NGLE			
	EH-SCP			
	SCP-12			
oUT1	SCLId	YES	Yes/No=enable/disable output scale's ID number, Prompt is "SCALE ID"	no
		no		
	Gross	YES	Yes/No=enable/disable output gross weight. Prompt is "GROSS"	no
		no		
	tARE	YES	Yes/No=enable/disable output tare weight. Prompt is "TARE"	no
		no		
	NEt	YES	Yes/No=enable/disable output net weight. Prompt is "NET"	YES
		no		
	PERCoNE	YES	Yes/No=enable/disable output weight percentage. Prompt is "PERCENTAGE"	no
		no		

Sub-Menu1	Sub-Menu2	Option	Remark	18562500 Setting
oUt 1	UPCEYE	YES	Yes/No=enable/disable output weight of 1% percentage. Prompt is "1% REF WT"	No
		No		
	COUPE	YES	Yes/No=enable/disable output counts. Prompt is "QUANTITY"	No
		No		
	PEYE	YES	Yes/No=enable/disable output piece weight. Prompt is "PIECE WT"	No
		No		
	bñi	YES	Yes/No=enable/disable output height and BMI. Prompt is "HEIGHT" and "BMI"	No
		No		
	ACCUñU	YES	Yes/No=enable/disable output accumulation times and total. Prompt is "ACC. N" and "TOTAL"	No
		No		
	DATE	YES	Yes/No=enable/disable output date. Prompt is "DATE"	No
		No		
t,ñE	YES	Yes/No=enable/disable output time. Prompt is "TIME"	No	
	No			
Ad.CoDE	YES	Yes/No=enable/disable output ADC's code. Prompt is "A/D CODE"	No	
	No			
bAteñoL	YES	Yes/No=enable/disable output voltage of battery. Prompt is "VOLTAGE"	No	
	No			
StAteUs	YES	Yes/No=enable/disable output scale's status. Prompt is "STATUS"	No	
	No			
bL,ñE	NoñE	How many blank lines after strings output: NONE=no blank line; LINE1/2/3/4=there're 1, 2,3 or 4 blank lines after strings, used for paper feed forward 1/2/3/4 lines.	L,ñE 1	
	L,ñE 1			
	L,ñE 2			
	L,ñE 3			
bAUd.rE	1200	selection of com2's baud rate	4800	
	2400			
	4800			
	9600			
	19200			
	38400			
bYe.FñE	8ñ1	selection of com2's byte format: 8N1=8 data bits, No parity check bit, 1 stop bit; 7O1=7 data bits,1 Odd parity check bit, 1 stop bit; 7E1=7 data bits,1 Even parity check bit, 1 stop bit; 7O2=7 data bits,1 Odd parity check bit, 1 stop bit; 7E2=7 data bits,1 Even parity check bit, 2 stop bit;	7E 1	
	7o 1			
	7E 1			
	7o 2			
	7E 2			
oUt.ñod	NoñE	Selection com2 output mode: NONE = No communication ; CONT=continuously output; PRINT=output after PRINT key pressed; CMD=output after a request command is received; PRT.CMD= output after PRINT key pressed or request command received; STABLE=output after scale is stable; Note: use PRINT or CMD to output data, the scale must be stable.	PrE.Cñd	
	CoñE			
	Pr,ñE			
	Cñd			
	PrE.Cñd			
StABLE	StABLE			
	StABLE			

Sub-Menu1	Sub-Menu2	Option	Remark	18562500 Setting
Com2	LAYOUT	MULTPL	Com2 output content and format set: MULTPL= the following selected item in OUT2 will be output use defined format; SINGLE= only displayed content and current status will be output, it's compatible with NCI-SCP01; EH-SCP= Command –response mode; SCP-12= only displayed content and current status will be output, it's compatible with NCI-SCP12 (NCI3835) ;	SCP-12
		SINGLE		
		EH-SCP		
		SCP-12		
OUT2	SCALEID	YES	Yes/No=enable/disable output scale's ID number, Prompt is "SCALE ID"	No
		No		
	GROSS	YES	Yes/No=enable/disable output gross weight. Prompt is "GROSS"	No
		No		
	TARE	YES	Yes/No=enable/disable output tare weight. Prompt is "TARE"	No
		No		
	NET	YES	Yes/No=enable/disable output net weight. Prompt is "NET"	YES
		No		
	PERCENT	YES	Yes/No=enable/disable output weight percentage. Prompt is "PERCENTAGE"	No
		No		
	UPCTY	YES	Yes/No=enable/disable output weight of 1% percentage. Prompt is "1% REF WT"	No
		No		
	COUNT	YES	Yes/No=enable/disable output counts. Prompt is "QUANTITY"	No
		No		
	PYE	YES	Yes/No=enable/disable output piece weight. Prompt is "PIECE WT"	No
		No		
	BNI	YES	Yes/No=enable/disable output height and BMI. Prompt is "HEIGHT" and "BMI"	No
		No		
	ACCUNU	YES	Yes/No=enable/disable output accumulation times and total. Prompt is "ACC. N" and "TOTAL"	No
		No		
DATE	YES	Yes/No=enable/disable output date. Prompt is "DATE"	No	
	No			
TIME	YES	Yes/No=enable/disable output time. Prompt is "TIME"	No	
	No			
ADCODE	YES	Yes/No=enable/disable output ADC's code. Prompt is "A/D CODE"	No	
	No			
BATTVOL	YES	Yes/No=enable/disable output voltage of battery. Prompt is "VOLTAGE"	No	
	No			
STATUS	YES	Yes/No=enable/disable output scale's status. Prompt is "STATUS"	No	
	No			
BLINE		NONE	How many blank lines after strings output: NONE=no blank line,; LINE1/2/3/4=there're 1, 2,3 or 4 blank lines after strings, used for paper feed forward 1/2/3/4 lines.	LINE1
		LINE1		
		LINE2		
		LINE3		
		LINE4		

Sub-Menu1	Sub-Menu2	Option	Remark	18562500 Setting	
bEEP	EEY	YES	Yes/No=enable/disable beep after a key pressed down	YES	
		NO			
	CONPAR	NONE	NONE =not beep; L.Low =beep when lower than low limitation; IN.LMT =beep when in range of low and high limitation; O.HIGH =beep when over high limitation; OUT.LMT =beep when lower than low limitation or higher than high limitation	,NLT	
		LLAY			
		,NLT			
OH, GH					
		OUT.LNT			
Hold	HLD.MOD	NONE	HOLD Mode: NONE =no hold function ; PS.PEAK =Positive Peak number Hold mode: scale will display and refresh the positive peak value from last zero setting; NG.PEAK =Negative PEAK number Hold mode. it's Similar with PS.PEAK, but negative number is used; TOGGLE =Press HOLD key to enter HOLD mode, if weight is over (NLD.RNG) and stable, the data will be frozen until press HOLD key again to exit; AVERAG =Average HOLD mode: in this mode, if weight is over (NLD.RNG), and its variation is less than (HLD.RNG), the average data in (AVG.TIM) will be frozen. Press HOLD key or (HLD.TIM) time elapsed to exit this mode; AUTO =Auto hold mode: it's similar with AVERAG mode, but if the one held load is removed, and a new load that is over (NLD.RNG) put on scale, the new load will be automatically frozen.	AUT	
		PS.PEAK			
		NG.PEAK			
		TOGGLE			
		AVERAG			
		AUT			
		AVG.T, N	1-60	average data time for HOLD mode:1-60s	3
		STB.T, N	3*AVG.T, N - 255	Waiting time for scale stable in HOLD mode: 3*(AVG.TIM) – 255s	9
	HLD.T, N	0-65535	Data HOLD time: 0=data will be frozen until HOLD key pressed; 1-65535=data frozen time is 1-65535s, after the time elapses, scale will exit HOLD mode	0	
	HLD.RNG	0-255	Vibration range of data that can be averaged and held in HOLD mode: 0=any data can be averaged; 1-255= only the data which vibration is in 1-255d can be averaged and held;	5	
oTHER	NLD.RNG	1-255	1-255=the range of weight is 1-255d; when current weight is less than this value, the scale can be regarded as empty , or the load on scale is removed. It must be bigger than (CONFI.MOTION).	10	

Sub-Menu1	Sub-Menu2	Option	Remark	18562500 Setting
o t H E r	C n d . b r C	N O N E	Source of the executed command selection: NONE=no any command will be executed; COM.1/.2= command from COM1/2 will be executed; COM.1.2= command from COM1,COM2 will be executed;	C o n . 1 . 2
		C o n . 1		
		C o n . 2		
		C o n . 1 . 2		
	R o F F . t	0 - 2 5 5	Auto off time: 0=not auto power off; 1-255=auto power off after 1-255 minutes, in this period, no operation or no weight changing	5
	o F F . n d	o F F	Auto off mode: OFF=turn off instrument; DSP.TIM= display time; AC.TIME=turn off when only battery is used, display time when AC adaptor is used。 If set to DSP.TM or AC.TIME, will continuously output "time".	o F F
		d s p . t , n		
A C . t , n E				
L C d . b l t	0 - 2 5 5	LCD backlight set: 0=always off; 1=always on; 2=press down [ZERO]+[UNIT] keys together more than 3s to turn on or turn off; 3-255=auto on when key operation or weight changing, auto off after 3-255s elapsed.	3 0	
L C d . c l t	C l t 1 - 8	LCD contraction level selection	C l t 8	
S C A L . i d	0 0 0 0 0 0 - 9 9 9 9 9 9	scale's ID number: 000000-999999	1 2 3 4 5 6	

CAL Submenu:

CAL				
SUBMENU1	SUBMENU2	OPTION	REMARK	
<i>CAL.ON</i> <i>CAL.OFF</i>			Seal switch is on or off	
<i>Zero</i>			Only perform zero point calibration, then go to <i>CAL.END</i> to end	
<i>LINE</i>	<i>CAL.P0</i>		Linear calibration point0: perform zero point calibration, this point cannot be omitted.	
	<i>CAL.P1</i>		Linear calibration point1: complete the first weight point calibration, this point cannot be omitted and standard weight must be over 10%FS.	
	<i>END.Y</i>	<i>YES</i>		End calibration? YES =go to <i>CAL.END</i> to end; NO =perform the next point calibration
		<i>NO</i>		
	<i>CAL.P2</i>		Linear calibration point2: complete the second weight point calibration, standard weight must be over 10%FS and must be larger than it in <i>CAL.P1</i> , this point can be omitted.	
	<i>END.Y</i>	<i>YES</i>		End calibration? YES =go to <i>CAL.END</i> to end; NO =perform the next point calibration
		<i>NO</i>		
<i>CAL.P3</i>		Linear calibration point3: perform third weight point calibration, standard weight must be over 10%FS and must be larger than it in <i>CAL.P2</i> , this point can be omitted.		
<i>Geo</i>	<i>Code</i>	<i>00-70</i>	Selection of Geographical Position Code 00-70	
	<i>GrAvty</i>	<i>9.76183</i> <i>-9.99999</i>	Input Gravity of User Location by keyboard	
<i>INPUT</i>			Input or view calibration parameters value	
<i>CAL.END</i>			Calibration end and restart	

NOTE:

For more details, pls refer to section “6.CALIBRATION”

MISC Submenu

MISC	
SUBMENU1	REMARK
<i>CodE</i>	Display ADC's code, this code can be after no-filter, filter1 or filter2; for more details, refer to section7
<i>uol</i>	Display voltage; calibrate voltage; refer to section7
<i>dAtE</i>	Display date and set date; refer to section7
<i>t, nE</i>	Display time and set time; refer to section7
<i>uEr</i>	Display firmware version; refer to section7

TEST Submenu

TEST	
SUBMENU1	REMARK
<i>dSP.t.t</i>	Test LCD or LED; for more details refer to section8
<i>Com1.rd</i>	Test COM1 receiving; refer to section8
<i>Com1.td</i>	Test COM1 transmitting; refer to section8
<i>Com2.rd</i>	Test COM2 receiving; refer to section8
<i>Com2.td</i>	Test COM2 transmitting; refer to section8
<i>KEY.t.t</i>	Test keys and buzzer; refer to section8

4. OPERATIONS

Change working mode

Press and hold the **PRINT/FUNC** key, then use \uparrow \downarrow \leftarrow key to choose and confirm to enter into weighing mode or counting mode.

Normal Weighing Mode

1. Power on the scale by pressing the **ZERO/ON/OFF** key.
2. If the display stabilizes but doesn't show zero, press the **ZERO/ON/OFF** key to set new zero point.
3. Place objects on the scale platform and read the weight on the indicator.

Note: Objects should be placed at the center of the platform. Corner or side loading heavy objects may risk overloading an individual load cell and damage the scale.

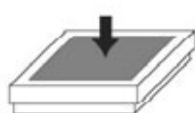

Yes



No



No

4. To change the weight unit of measure, press the **UNIT/DATA** key.

Note: Under certain conditions, g and lb:oz is not available. In trade applications, lb:oz should be prohibited. Please refer the following **tables (5-1 and 5-2)**:

5. To send data to another device via the serial port, press the **PRINT/FUNC** key.
6. Power off the scale by pressing and holding the **ZERO/ON/OFF** key for 4 seconds.

Table5-1: use Kg as primary unit:

Calibration division value	Display division value in different weight unit that can be used				
	kg	g	lb	oz	lb:oz
<i>0.0001kg</i>	0.0001kg	0.1g	0.0002lb	0.005oz	Not available
<i>0.001kg</i>	0.001kg	1g	0.002lb	0.05oz	Not available
<i>0.01kg</i>	0.01kg	10g	0.02lb	0.5oz	0.5oz
<i>0.1kg</i>	0.1kg	100g	0.2lb	5oz	Not available
<i>1kg</i>	1kg	Not available	2lb	50oz	Not available
<i>10kg</i>	10kg	Not available	20 lb	Not available	Not available
<i>0.0002kg</i>	0.0002kg	0.2g	0.0005 lb	0.01 oz	Not available
<i>0.002kg</i>	0.002kg	2g	0.005 lb	0.1 oz	0.1 oz
<i>0.02kg</i>	0.02kg	20g	0.05 lb	1oz	1 oz
<i>0.2kg</i>	0.2kg	200g	0.5 lb	10oz	Not available
<i>2kg</i>	2kg	Not available	5 lb	Not available	Not available
<i>20kg</i>	20kg	Not available	50 lb	Not available	Not available
<i>0.0005kg</i>	0.0005kg	0.5g	0.001 lb	0.02oz	Not available
<i>0.005kg</i>	0.005kg	5g	0.01 lb	0.2oz	0.2 oz
<i>0.05kg</i>	0.05kg	50g	0.1 lb	2oz	2oz
<i>0.5kg</i>	0.5kg	500g	1 lb	20oz	Not available
<i>5kg</i>	5kg	Not available	10 lb	Not available	Not available
<i>50kg</i>	50kg	Not available	Not available	Not available	Not available

Table5-2: use LB as primary unit:

Calibration division value	Display division value in different weight unit that can be used				
	kg	g	lb	oz	lb:oz
0.0001lb	Not available	Not available	0.0001lb	0.002oz	Not available
0.001 lb	0.0005 kg	0.5g	0.001 lb	0.02oz	Not available
0.01 lb	0.005 kg	5g	0.01 lb	0.2oz	0.2 oz
0.1 lb	0.05 kg	50g	0.1 lb	2oz	2 oz
1 lb	0.5 kg	500g	1 lb	20oz	Not available
10 lb	5 kg	Not available	10 lb	Not available	Not available
0.0002 lb	0.0001 kg	0.1g	0.0002 lb	0.005 oz	Not available
0.002 lb	0.001 kg	1g	0.002 lb	0.05 oz	Not available
0.02 lb	0.01 kg	10g	0.02 lb	0.5 oz	0.5 oz
0.2 lb	0.1 kg	100g	0.2 lb	5 oz	Not available
2 lb	1 kg	Not available	2 lb	50 oz	Not available
20 lb	10 kg	Not available	20 lb	Not available	Not available
0.0005 lb	0.0002 kg	0.2g	0.0005 lb	0.01 oz	Not available
0.005 lb	0.002 kg	2g	0.005 lb	0.1 oz	0.1 oz
0.05 lb	0.02 kg	20g	0.05 lb	1 oz	1 oz
0.5 lb	0.2 kg	200g	0.5 lb	10 oz	Not available
5 lb	2 kg	Not available	5 lb	Not available	Not available
50 lb	20 kg	Not available	50 lb	Not available	Not available

ZERO

If the display does not show 0, and there is not an object on the platform, press the **ZERO/ON/OFF** key to zero the reading.

Zero range: $\pm 2\%$ * full Capacity.

The zero function is unavailable when the displayed reading is out of the zero range and the indicator will show the error message $\square \text{-----}$ or $\square \text{-----}$, meaning the scale is over or under zero range

Setting a Tare Weight

1. Zero the scale as described above.
2. Place an empty container on the platform, press the **TARE/PRESET** key. The display will return to zero, eliminating the weight of the container. "NET" will be lit on the display.
3. Place the material or object to be weighed in the container. The net weight will be displayed.
4. To exit tare mode, remove all weight from the scale. The display will show a negative weight. Press the **TARE/PRESET** key to return the display to zero.

Setting a Pre-Determined Tare Weight

1. Zero the scale as described above.
2. Press and hold the **TARE/PRESET** key until "P.TARE" shows quickly, then the tare weight will be displayed. The first digit and NET flash in the display.

- Input the tare weight using the \uparrow \downarrow \rightarrow keys. After inputting the tare weight, press the **TARE/PRESET** key to confirm. "NET" will be lit in the display.
Note: Tare weight must be greater than zero and no more than the scale's maximum capacity.
- Place the object to be weighed onto the scale platform. The net weight will be displayed.
- To exit tare mode, remove all weight from the scale. The display will show a negative weight. Press the **TARE/PRESET** key to return the display to zero.

Note: The indicator can only save one tare weight. Entering a new tare weight will automatically replace the old one.

Pre-Determined tare weight will be lost after the scale is powered off.

Check Weighing (Data Compare) in Normal Weighing Mode

The check weighing or data compare function allows the user to input a pre-set range, and the display will indicate whether the weighed value is within that range, and indicate if it is too high or too low.

- Press and hold the **UNIT/DATA** key for 4 seconds to input the comparative data range.
- " UN, ELB " or " UN, ELC " will be displayed first. Use the **UNIT/DATA** keys to select the comparison unit of measure. Press the **TARE/PRESET** key to confirm.
- After H, CH is shown quickly, the last **Hi** limit value will be displayed (the default value is 000000). **HI** on the display will be lit. Use the \uparrow \downarrow \rightarrow keys to input the upper limit of the range and press the **TARE/PRESET** key to confirm and move to the next step.
- LO will be shown quickly, the last **Lo** limit value will be displayed (the default value is 000000). **LO** on the display will be lit. Use the \uparrow \downarrow \rightarrow keys to input the lower limit of the range and press the **TARE/PRESET** key to confirm. Press **ZERO/ON/OFF** key to exit and go back to the normal weighing mode.

NOTE: If the upper limit is 0, or if it is less than the lower limit, check weighing mode will automatically be exited.

- After an acceptable range has been set, check weighing may begin. If the weighed value is within the specified range, **OK** will be displayed on the indicator and an audible beep will sound. If the value is outside the specified range, **HI** or **LO** will be displayed with no audible beep.
- To turn check weighing off, follow the above instructions and change the upper limit to zero.

Accumulation Mode

The accumulation function allows storage of weighed values and the summation of those values. This function can accumulate weights, piece counts, and percentages in normal weighing mode, counting mode, and percent weighing mode respectively.

- With a load on the scale, press the **ACC/TOTAL** key to add the displayed value to the accumulated total. The indicator will first display the times of accumulation (e.g. if this is the 5th accumulated

value, it will display *ACC.005*), and then display the accumulated sum total thus far, then it will, display the load weight.

Note: Only loads exceeding the minimum weight (default of 10d, where d = the scale's readability, see **specifications**) can be accumulated. This setting (**USER-OTHER-NLD.RNG**) can be modified from its default within **User Setup** mode, but changes will impact other functions such as **HOLD**.

2. Remove the load and place another load to continue accumulating, press and release **ACC/TOTAL** to add the new value.

Note: To avoid duplicating a value for a same load, the accumulation function requires the original load to be removed before a new value can be accumulated.

3. To view the total accumulated data at any time, press and hold the **ACC/TOTAL** key for 4 seconds. It will alternatively display the accumulation times and the accumulated sum total thus far (weight or quantity), until the **ACC/TOTAL** key is pressed again. Accumulated times and total values can be displayed or sent to another device via the serial port by pressing and releasing the **PRINT/FUNC** key.
4. To clear and reset the accumulated data, press and release the **ZERO/ON/OFF** key while total accumulated data and the accumulated sum total are alternatively displayed.

Note: When the **HOLD** function is enabled and working in **PEAK HOLD** mode, the Accumulation function will automatically be disabled.

Counting Mode

The counting function calculates and displays the piece quantity of the load that has been weighed.

1. From normal weighing mode or percent-weighing mode, press and hold the **PRINT/FUNC** key for 4 seconds. Use the \uparrow \downarrow keys to select **COUNT**, then press the **TARE/PRESET** key to confirm and enter counting mode.

Note: In counting mode, the **ZERO**, **TARE**, **PRINT**, **HOLD**, **PRESET TARE**, **ACC**, **SETUP**, and **ON/OFF** functions are all available.

2. There are two ways to input the piece weight.

- a. To input a known piece weight directly:

- i. Press the **UNIT/DATA** key. When *1PP.PUL* is shown, press the **TARE/PRESET** key to enter "Input Piece Weight" mode.

Note: At any time you can press **ZERO/ON/OFF** to exit "Input Piece Weight" and return to counting mode.

- ii. When *UN1.EEG* is shown, use the \uparrow \downarrow keys to select the piece weight unit of measure, and then use the **TARE/PRESET** key to confirm.
- iii. The previously entered piece weight will be shown (the default value is *000000*). Use the \uparrow \downarrow \rightarrow keys to input a new piece weight, then press and hold the

HOLD/SETUP key for 4 seconds to input the decimal point. Press the **TARE/PRESET** key to confirm and return to counting mode.

Note: If the input piece weight is less than 0.5d (where d = the scale's readability, see specifications), the indicator will display *PUE.Er* and will automatically return to counting mode.

b. To input the piece weight by weighing a sample of a known quantity:

- i. Press the **UNIT/DATA** key. When *1PP.PUE* is shown, use \uparrow \downarrow keys to select *5PL.PUE*. Press the **TARE/PRESET** key to enter "Get Piece Weight" mode.

Note: At any time you can press **ZERO/ON/OFF** to exit "Get Piece Weight" and return to counting mode.

- ii. When *5PL.L \square* is shown, remove any load from the platform and press the **TARE/PRESET** key to confirm. If the scale hasn't stabilized, *5PL.L \square* will flash. After it has stabilized, it will go to the next step.
- iii. When *5PL.H \square* is shown, place a sample of a known quantity object onto the scale platform and press the **TARE/PRESET** key. If the scale hasn't stabilized, *5PL.H \square* will flash.
- iv. If the scale has stabilized, *1PP.PC5* will be shown quickly, then the previously entered piece weight will be displayed (the default value is *0000000*, and the position of decimal point is determined by **CONFIG-FUNC-PERCEN** setting). Use the \uparrow \downarrow \rightarrow keys to input the sample quantity and press the **TARE/PRESET** key to confirm.
Note: If the input piece weight is less than 0.5d (where d = the scale's readability, see specifications), the indicator will display *PUE.Er* and will automatically return to counting mode.
- v. Once an acceptable piece weight has been entered, the scale will return to counting mode.

Note: The piece weight that has been entered will be saved, even after powering off.

The indicator can only save one piece weight.

Entering a new piece weight will automatically replace the old one.

Check Counts (counts compare) in Counting mode:

The check Counts function allows the user to input a pre-set range, and the display will indicate whether the weighed value is within that range, or indicate if it is too high or too low.

1. Press and hold the **UNIT/DATA** key for 4 seconds to input the comparative data range.
2. *H \square GH* will be shown and *0000000* will be displayed. The **HI** Annunciator on the display will be lit. Use the \uparrow \downarrow \rightarrow keys to input the upper limit of the range (weight, piece quantity, or percentage depending on initial mode) and press the **TARE/PRESET** key to confirm and move to the next step.

3. $L \underline{O}$ will be shown and 000000 will be displayed. The **LO** Annunciator on the display will be lit. Use the \uparrow \downarrow \rightarrow keys to input the lower limit of the range and press the **TARE/PRESET** key to confirm.

NOTE: If the upper limit is 0, or if it is less than or equal to the lower limit, check weighing mode will automatically be exited.

4. After an acceptable range has been set, check weighing may begin. If the weighed value is within the specified range, **OK** Annunciator on the display will be lit and an audible beep will be sound. If the value is outside the specified range, **HI** or **LO** Annunciator on the display will be lit with no audible beep. Audible beep parameters can be changed from their defaults in **User Setup** mode.

Percent Weighing Mode

In this mode, the scale will weigh the unit on the platform, calculate and display its percentage after the unit-percentage-weight of goods is obtained. (NOTE: If 100% display format is set to 100%, 100.0% or 100.00% in CONFIG-FUNC-PERCEN menu item, then the unit-percentage-weight is the weight of 1%, 0.1% or 0.01%)

1. To make percent weighing function available, ensure that the **CONFIG-FUNC-PERCEN** menu item is not set to **NO**.
2. To enter percent weighing mode, in normal weighing or counting mode, press and hold **PRINT/FUNC** key for 4 seconds, $\underline{P E} \text{ , } \underline{G H I C} \text{ } \underline{O U P E}$ will be shown, use \uparrow \downarrow keys to select $\underline{P E r C E N}$, then press **TARE/PRESET** to confirm and enter percent weighing mode. Before new unit-percentage-weight is calculated, the last unit-percentage-weight will be used.
Note: In percent weighing mode, the function of **ZERO**, **TARE**, **PRINT**, **HOLD**, **PRESET TARE**, **ACC**, **SETUP**, **ON/OFF** are available.
3. There are two ways to obtain the unit-percentage-weight,:
 - a. Using the input weight and its percentage, the scale calculates the unit-percentage-weight:
 - i. Press the **UNIT/DATA** key, When $\text{ , } \underline{N P P C E}$ is shown, press the **TARE/PRESET** key to continue.
 - ii. Before inputting the weight, use the \uparrow \downarrow keys to select the percentage from 1%, 2%, 5%, 10%, 20%, 50% and 100%, corresponding to the weight that will be inputted in the following steps. Press the **TARE/PRESET** key to confirm.
 - iii. When $\underline{U P} \text{ , } \underline{E P G}$ is shown, use the **UNIT/DATA** key to select the unit of input weight, then use the **TARE/PRESET** key to continue. Press the **ZERO/ON/OFF** key to exit.
 - iv. When the last stored unit-percentage-weight data is shown (the default value is 000000), use the \uparrow \downarrow \rightarrow keys to input the new unit-percentage-weight, then press the **HOLD/SETUP** key for more than 4 seconds to input the decimal point. Press the **TARE/PRESET** key to confirm, save, and to return to percent weighing mode. If the calculated unit-percentage-weight is less than 0.5d, the indicator will display $\underline{P C E E r}$

and return back to percent weighing mode.

b. Using the weigh samples weight when percentage is known:

- i. Press the **UNIT/DATA** key. When *1PP.PCE* is shown, use the \uparrow \downarrow keys to select *5PL.PCE*, then press the **TARE/PRESET** key to weigh samples (when the percentage is known) and to calculate the piece weight. Press the **ZERO/ON/OFF** key to exit and return to percent weighing mode.
- ii. When *5PLL* is shown, remove all samples from scale and press the **TARE/PRESET** key to confirm. Before the scale is stable, *5PLL* will be flashed. When the scale becomes stable, continue to the next step. Press the **ZERO/ON/OFF** key to exit and return to percent weighing mode.
- iii. When *5PLH* is shown, place samples (when the percentage is known) onto the scale. Press the **TARE/PRESET** key to confirm reading weight. Before the scale is stable, *5PLH* will be flashed. When the scale becomes stable, continue to the next step. Press the **ZERO/ON/OFF** key to exit and return to percent weighing mode.
- iv. After *1PP.PCE* is displayed, the previously entered percent will be shown (the default value is *000000*, and the position of decimal point is determined by **CONFIG-FUNC-PERCEN** setting), use the \uparrow \downarrow \rightarrow keys to input the percentage of samples and Press the **TARE/PRESET** key to confirm. If the calculated unit-percentage-weight is less than 0.5d, the indicator will display *PCE.Er* and return to percent weighing mode, otherwise, after the reasonable unit-percentage-weight is calculated, the scale will return to percent weighing mode. The calculated unit-percentage-weight can be saved when the scale has been powered off and it can be used the next time the scale is powered on.

Check Percent (percentage compare) in Percent weighing mode:

To make the percentage compare function available, **CONFIG-FUNC-COMPAR** menu item should be set to **YES**, and high and low limitation of percentage should be set according to following steps:

1. In percent weighing mode, press the **UNIT/DATA** key for more than 4 seconds to input compare data of high and low.
2. After *HIGH* is shown quickly, *000000* will then be displayed, use the \uparrow \downarrow \rightarrow keys to input high percentage number and press the **TARE/PRESET** key to confirm. Annunciator of **HI** will then be shown. Press the **ZERO/ON/OFF** key to exit and return to percent weighing mode.
3. After *LOW* is displayed quickly, *000000* will then be displayed, use the \uparrow \downarrow \rightarrow keys to input low percentage number and press the **TARE/PRESET** key to confirm. Annunciator of **LO** will then be shown. Press the **ZERO/ON/OFF** key to exit and return to counting mode.

NOTE: If the High number is 0 or is equal or less than low number, the comparison will be

disabled.

4. After a reasonable limitation is set and compare is active, one of annunciators **HI**, **OK**, **LO** will be displayed, and the beeper will sound according to its setting in **USER-BEEP**.

BMI Working Mode (closed on ECS-B)

1. For BMI working Mode to be available, **CONFIG-FUNC-BMI** menu item should be set to **YES**.
2. To enter BMI Working mode: **CONFIG-FUNC-ACCUMU= Yes**: If In normal weighing mode, percent weighing mode, or counting mode, press and hold **FUNC** key for 4 seconds, one of $\underline{\text{UE}}$, $\underline{\text{GH}}$, $\underline{\text{COPPE}}$ / $\underline{\text{PERCEPE}}$ will be shown, use the \uparrow \downarrow keys to select $\underline{\text{bni}}$, then press **TARE/PRESET** key to confirm BMI mode.
3. When the scale enters this mode, " $\underline{\text{Cnxxx}}$ " (means: last input height is xxx cm) or " $\underline{\text{, Pxx.x}}$ " (means: last input height is xx.x inch) will be displayed, and to wait for input height:
 - 1) To change height unit to cm or inch, press the **UNIT/DATA** key;
 - 2) To change height number, use the \uparrow \downarrow keys;
 - 3) To quickly increase or decrease the number, press and hold **PRINT/FUNC** or **ACC/TOTAL** key ;
 - 4) Press the **TARE/PRESET** key to confirm the input. Press the **ZERO/ON/OFF** key to exit input data mode and return to BMI working mode. The range of height is 50-250cm (19.7-98.4inch) and default is 170cm(66.9inch)
4. In this mode, when BMI number is shown (BMI annunciator is also lit), or weight number is shown (BMI and kg or lb annunciators are on), press the **ACC/TOTAL** key to select weight or BMI number to be displayed. When the weight is displayed, the unit can be selected by pressing the **UNIT/DATA** key, then the BMI and weight unit will be displayed at same time.
5. In this mode, when current net weight is less than **NLD.RNG**, the indicator will go to display weight number if **CONFIG-FUNC-ACCUMU= No**; or the indicator will back to original working mode if **CONFIG-FUNC-ACCUMU= Yes**.

Weight Fine-tune (closed on ECS-B)

With this function, the user can adjust the displayed weight (to a minimal extent) with no need for standard weight. Please note:

- (1) The scale must have been calibrated before this adjustment
 - (2) The range of adjustment is "(current displayed weight) x (0.9-1.1)". This means the range is about $\pm 10\%$
 - (3) The "**CONFIG-REGULA =NONE**" and "**CONFIG-FUNC-WT.ADJ=YES**" must be set.
1. To enter this mode, in normal weighing model, place a load (suppose: its correct weight is 1230.0lb) onto scale, then indicator will display the load's weight, shown as " $\underline{1234.5}$ lb". Press the **TARE/PRESET** key and **ZERO/ON/OFF** key at same time until first digit flashes, which means indicator has entered into "weight fine-tune" mode.

2. Use the \uparrow \downarrow \rightarrow keys to input correct weight (*12300*). After confirmed by **TARE/PRESET**, the active correct weight will be displayed and the digits will no longer be flashing. Then, the displayed weight will be adjusted by this ratio (*12300/12345*) and this ratio will be active until the next modification.
3. To remove effect of this ratio, follow one of the two options below:
 - a. Perform standard calibration, refer to the section on “CALIBRATION”.
 - b. Remove weight from the scale, press the **ZERO/ON/OFF** to display *0*, then place a load onto scale. A number will be displayed, (suppose it displayed *12300* lb but the original number is *12345*) ; Press **TARE/PRESET** key and **ZERO/ON/OFF** key at same time until first digit flashes, which means indicator has entered into “weight fine-tune” mode. Press the **HOLD/SETUP** key for the displayed weight to be restored to *12345*, and then press **TARE/PRESET** to confirm and exit to normal weighing mode.

HOLD Function

NOTE: In trade application, HOLD function should be prohibited!

1. **HOLD** function can be used to freeze the display number. In this mode, scale can catch a dynamic number, hold a stable number, or average an unstable number, then HOLD (freeze) this number temporary for the user to watch or record. This function can be used in normal weighing mode, counting mode and percent weighing mode. After entering **HOLD** mode, the speed of A/D converter can be increased to 80Hz (if **USER-HOLD-AD.H.SPD** is set to **YES**) from the original 10Hz for some dynamic weighing applications. With the hold function, it is possible to weigh restless weighing samples such as live animals or moving objects. The indicator provides a special mode setting to accommodate sample’s movements.
2. To make the **HOLD** function active, the **CONFIG-FUNC-HOLD** menu item must be set to **YES**; menu items of **USER-HOLD-HLD.MOD** /-AVG.TIM /-HLD.TIM /-STB.TIM, **USER-OTHER-NLD.RNG** need be set to reasonable values.

To increase the speed for sampling of weight, set **USER-HOLD-AD.H.SPD** menu item to **YES**.

To enter **HOLD** working mode, press the **HOLD/SETUP** key when the scale is in normal weighing mode, counting mode or percent weighing mode.

3. There are several **HOLD** modes use to freeze the display data:
 - a. Positive Peak Number HOLD mode
 - b. Negative Peak Number HOLD mode
 - c. Toggle HOLD mode
 - d. Average HOLD mode
 - e. Auto HOLD mode

The following information contains details for these HOLD modes:

- a. **Positive Peak HOLD:**

When **USER-HOLD-HLD.MOD** is set to **PS.PEAK**, the hold mode is positive peak hold mode. When the scale first enters this working mode, it will display the largest positive number that is from the time of zero-point set. After entering this working mode, the scale will always catch and refresh with the largest positive number. To exit **HOLD** mode,

- press the **HOLD/SETUP** key.
- b. **Negative Peak HOLD:**
When **USER-HOLD-HLD.MOD** is set to **NG.PEAK**, the hold mode is negative peak hold mode. When the scale first enters this working mode, it will display the largest negative number that is from the time of zero-point set. After entering this working mode, the scale will always catch and refresh with the largest negative number. To exit **HOLD** mode, press the **HOLD/SETUP** key.
 - c. **Toggle HOLD:**
When **USER-HOLD-HLD.MOD** is set to **TOGGLE**, the hold mode is toggle hold mode ---a manual Hold function. After entering this working mode, the scale will freeze and display number if the scale is stable. Only the weight that is over **USER-OTHER-NLD.RNG** (zero 'dead' band) can be held. To exit **HOLD** mode, press the **HOLD/SETUP** key. If the length of time that the scale is unstable for more than **USER-HOLD-STB.TIM**, **STB.ER** will be shown. Press the **TARE/PRESET** key to start averaging again, or press the **HOLD/SETUP** key to exit.
 - d. **Average HOLD:**
When **USER-HOLD-HLD.MOD** is set to **AVERAG**, the hold mode is average hold mode. After entering this working mode, the scale will freeze and display number if the scale is stable. If the scale is not stable, but the variation is less than **USER-HOLD-HLD.RNG**, the scale will average data in **USER-HOLD-AVG.TIM**, then freeze and display the number. Only the weight that is over **USER-OTHER-NLD.RNG** can be frozen. Scale will exit **HOLD** mode according to the setting of **USER-HOLD-HLD.TIM**. If the time of scale variation is over **USER-OTHER-NLD.RNG** or is more than **USER-HOLD-STB.TIM**, **STB.ER** will be shown, press **TARE/PRESET**, **UNIT/DATA**, **ACC/TOTAL** or **PRINT/FUNC** to start averaging again, or press **HOLD/SETUP** key to exit.
 - e. **Auto HOLD:(Default setting)**
When **USER-HOLD-HLD.MOD** is set to **AUTO**, the hold mode is auto-hold mode: different subjects can be weighed one after another without pressing any buttons. After entering this working mode, the scale will freeze and display number if the scale is stable. If the scale is not stable, but the variation is less than **USER-HOLD-HLD.RNG**, the scale will average data in **USER-HOLD-AVG.TIM**, then freeze and display the number. Only the weight that is over **USER-OTHER-NLD.RNG** can be frozen. If the held weight is removed, and a new load is placed on the scale, the scale will automatically hold the new number of the load. The scale will exit **HOLD** mode according to the setting of **USER-HOLD-HLD.TIM**. If the time of the scale variation is over **USER-OTHER-NLD.RNG** or is more than **USER-HOLD-STB.TIM**, **STB.ER** will be shown, press **TARE/PRESET** to start averaging again, or press **HOLD/SETUP** key to exit.
4. In Positive or Negative Peak **HOLD** mode, the **PEAK** and **HOLD** annunciator will be lit, and for other **HOLD** modes the **HOLD** annunciator will be lit. When **HOLD** annunciator is flashing, the displayed number is live. When **HOLD** annunciator become steady, the displayed number is frozen.

Details about Serial Communication

1. COM1 is RS232, communication wires come from RS232 connector, and TXD0, RXD0 and GND are used. Please refer to section 9 for connector details
2. COM2 is USB used as a virtual RS232, communication wires come from USB connector, and TXD1, RXD1 and GND are used, Please refer to section 9 for connector details.
3. The baud rate and byte format is set by **USER-COM1/2-BAUD.RT** and **USER-COM1/2-BYT.FMT**. Responses to serial commands will be immediate, or within one weight measure cycle of the scale. One second should be adequate for use as a time-out value by remote (controlling) device.
4. The length of each item in a transition string:
 - a. Reading data --- 6bytes
 Data polarity ----1byte: “-” for negative, and followed the first digit; “ ” for positive.
 Decimal point ---1byte: “.”
 Measure unit ---1-5bytes:“ lb”,“ kg”, “lb:oz”, “pcs”,“%”, Units are always lower case, left aligned
 Current status-- 4bytes
 - b. If the weight is overcapacity, the scale will display “-----”return eight “^” characters (the field of polarity, decimal point, weight data is filled by “^”).
 - c. If the weight is under capacity, it will display “_____”return eight “_” characters (the field of polarity, decimal point, and weight data is filled by “_”).
 - d. If the zero point is resulting in an error, it will display xxx return eight “-“ characters (the field of polarity, decimal point, and weight data is filled by “-”).
 - e. Useless leading 0 before digits is suppressed. Reading weight is right aligned.
5. Key to symbols used

<LF>	Line Feed character (hex 0AH)
<CR>	Carriage Return character (hex 0DH)
<ETX>	End of Text character (hex 03H)
<SP>	Space (hex 20H)
H ₁ H ₂ H ₃ H ₄	Four current status bytes
<P>	Polarity character: “—” or “ ”
W ₁ ---W ₆	Reading data, 1-6 bytes (six digits)
<DP>	Decimal point
U ₁ U ₂ U ₃ U ₄ U ₅	Measure units, kg, lb, lb:oz , % or pcs; 2-5 bytes
<Add>	Address of scale; 2 bytes (00-99)
<Prompt>	Prompt characters of output content; max. 1 bytes

The bit definition of H₁H₂H₃ H₄:

Bit	Byte 1 (H1)	Byte 2 (H2)	Byte 3 (H3)	Byte 4 (H4)
0	0=stable	0= not under capacity	00=compare disable	00=normal weighing
	1= not stable	1= under capacity	01=lower limit	01=count weighing
1	0= not at zero point	0= not over capacity	10=ok	10=percent weighing
	1= at zero point	1= over capacity	11=upper limit	11=other mode
2	0=RAM ok	0=ROM ok	0= gross weight	0=not in HOLD
	1= RAM error	1=ROM error	1= net weight	1=in HOLD
3	0= eeprom OK	0=calibration ok	0=initial zero ok	0=battery ok
	1= eeprom error	1=calibration error	1=initial zero error	1=low battery
4	always 1	always 1	always 1	always 1
5	always 1	always 1	always 1	always 1
6	always 0	always 1	always 1	always 0
7	parity	parity	parity	parity

6. Communication Details when **USER-COM1/2-LAYOUT** is set to **5, NGL E**:

a. Commands and response

i. Command: **W<CR>** (57h 0dh), request current reading

Response:

- ① <LF> ^ ^ ^ ^ ^ ^ ^ ^ U₁U₂ U₃U₄U₅<CR><LF> H₁H₂H₃ H₄<CR><ETX>---over capacity
 - ② <LF> _ _ _ _ _ _ _ _ U₁U₂ U₃ U₄U₅<CR><LF> H₁H₂H₃ H₄<CR><ETX>---under capacity
 - ③ <LF> - - - - - - - - U₁U₂ U₃ U₄U₅<CR><LF> H₁H₂H₃ H₄<CR><ETX>---zero-point error
- Note:** U₁U₂ U₃ U₄U₅ is 1,2,3 or 5 bytes according to current unit: %, kg, lb, pcs, lb:oz
- ④ <LF><P>W₁W₂W₃W₄W₅<DP>W₆ U₁U₂ U₃ U₄U₅<CR><LF> H₁H₂H₃ H₄<CR><ETX>---normal data

Note: (1) The decimal point position is determined by **CONFIG-PRIM.D**

(2) If current unit is "lb:oz", the format will be similar with following:

<LF><P>W₁W₂W₃**lb**<SP>W₄W₅<DP>W₆**oz**<CR><LF> H₁H₂H₃H₄<CR><ETX>

ii. Command: **S<CR>** (53h 0dh), request current status

Response: <LF> H₁H₂H₃ H₄<CR><ETX>

iii. Command: **Z<CR>** (5ah 0dh)

Response: Zero function is activated (simulate **ZERO** key) and it returns to current scale status.

<LF> H₁H₂H₃H₄<CR><ETX>

If ZERO function cannot be activated, it will return to current scale status.

iv. Command: **T<CR>** (54h 0dh)

Response: TARE function is activated (simulate **TARE** key), and then returns scale status.

<LF> H₁H₂H₃ H₄ <CR><ETX>

If TARE function cannot be activated, it will return to current scale status.

v. Command: **U<CR>** (55h 0dh)

Response: Change unit of measure (simulate **UNIT** key) and return scale status with new unit,

the new unit of measure should be allowed to use

<LF> U₁U₂ U₃ U₄U₅<CR><LF> H₁H₂H₃ H₄<CR><ETX>

vi. Command: **L<CR>** (4ch 0dh)

Response: If Hold function can be activated, it will enable/disable hold function (simulate **HOLD** key), and returns scale status.

<LF> H₁H₂H₃H₄<CR><ETX>

vii. Command: **X<CR>** (58h 0dh)

Response: power off the scale, just like press down the **ZERO/ON/OFF** key to turn off the scale.

viii. Command: all others

Response: Unrecognized command

<LF>? <CR><ETX>

b. Summary of Command and Response:

Command		Response
ASCII	HEX	
W<CR>	57 0d	Read scale weight: ①<LF> ^ ^ ^ ^ ^ ^ ^ ^ U ₁ U ₂ U ₃ U ₄ U ₅ <CR><LF> H ₁ H ₂ H ₃ H ₄ <CR><ETX>---over capacity ②<LF> _____ U ₁ U ₂ U ₃ U ₄ U ₅ <CR><LF> H ₁ H ₂ H ₃ H ₄ <CR><ETX>---under capacity ③<LF>----- U ₁ U ₂ U ₃ U ₄ U ₅ <CR><LF> H ₁ H ₂ H ₃ H ₄ <CR><ETX>---zero-point error ④ <LF><p>W ₁ W ₂ W ₃ W ₄ W ₅ <dp>W ₆ U ₁ U ₂ U ₃ U ₄ U ₅ <CR><LF>H ₁ H ₂ H ₃ H ₄ <CR><ETX>---normal data
S<CR>	53 0d	<LF> H ₁ H ₂ H ₃ H ₄ <CR><ETX>; read scale status
Z<CR>	5a 0d	<LF> H ₁ H ₂ H ₃ H ₄ <CR><ETX> ; simulate ZERO key
T<CR>	54 0d	<LF> H ₁ H ₂ H ₃ H ₄ <CR><ETX> ; simulate TARE key
U<CR>	55 0d	<LF> U ₁ U ₂ U ₃ U ₄ U ₅ <CR><LF> H ₁ H ₂ H ₃ H ₄ <CR><ETX>; simulate UNIT key
L<CR>	4c 0d	<LF> H ₁ H ₂ H ₃ H ₄ <CR><ETX>; simulate HOLD key
X<CR>	58 0d	power off the scale, simulate OFF key
others		<LF>? <CR><ETX>

7. Communication Details when **USER-COM1/2-LAYOUT** is set to $\bar{n}ULL \bar{E}PL$:

a. Output string frame:

<LF><Prompt><p>W₁W₂W₃W₄W₅<Dp>W₆ U₁U₂ U₃ U₄U₅<CR>

..... --- Line number and content are determined by setting of **USER-OUT1/2-xxxx**

<LF><Prompt>H₁H₂H₃ H₄<CR> --- **USER-OUT1/2-STATUS** is set to **YES**

.....

<LF>

- (1) The decimal point position is determined by **CONFIG-PRIM.D**
- (2) The unit position and bytes is determined by which current unit is used.
- (3) The details of <Prompt> refer to the content in **USER Submenu**.
- (4) In hold mode, if ADC conversion speed is set high speed (80Hz), and **USER-COM1/2-LAYOUT** is set to $\bar{n}ULL\bar{E}PL$, and many contents are selected to output, the output contents from COM1 or COM2 may not catch up with the data processed in indicator. If you want to watch "real time" data, select fewer output contents and set higher baud rate for C<CR> --- **USER-OUT1/2-LINE** is set to **LINE1/2/3/4**
..... ---The number of blank lines is determined by **USER-OUT1/2-LINE** setting
<ETX> --- Last byte of string frame

b. Layout examples when **USER-OUT1/2-xxxx** is set to **YES**:

In weighing mode:	
SCALE ID:	123456
GROSS:	123lb 4.56oz
TARE:	11lb 2.22oz
NET:	112lb 2.34oz
ACC. N:	8
TOTAL:	789lb 15.2oz
DATE:	2011-06-12
TIME:	12:34:56
A/D CODE:	1234567
VOLTAGE:	6.7V
STATUS:	bpq2

In counting mode:	
SCALE ID:	123456
GROSS:	1234.55kg
TARE:	12.15kg
NET:	1222.40kg
QUANTITY:	24448pcs
PIECE WT:	0.05kg
ACC. N:	10
TOTAL:	23456pcs
DATE:	2011-06-12
TIME:	12:34:56
A/D CODE:	1234345
VOLTAGE:	6.7V
STATUS:	bpq2

In percent weighing mode:	
SCALE ID:	123456
GROSS:	12345lb
TARE:	10lb
NET:	12335lb
PERCENTAGE:	91.4%
1% REF. WT:	135lb
ACC. N:	3
TOTAL:	271.6%
DATE:	2011-06-12
TIME:	12:34:56
A/D CODE:	1231234
VOLTAGE:	6.7V
STATUS:	bpq2

In BMI mode:	
SCALE ID:	123456
GROSS:	110.0kg
TARE:	10.0kg
NET:	100.0kg
HEIGHT:	170cm
BMI :	34.6
DATE:	2011-06-12
TIME:	12:34:56
A/D CODE:	1231234
VOLTAGE:	6.7V
STATUS:	bpq2

8. Communication Details when **USER-COM1/2-LAYOUT** is set to *EH-5CP*:

- a. This protocol of serial communication is similar to the **TOLEDO PS60** protocol. The baud rate and data format is set by User menu.
- b. Output status bit meaning:

Bit	Status Byte
0	0=Stable weight data
	1=Scale in motion
1	0= Within weighing range
	1= Over capacity
2	0=Within weighing range
	1= Under zero
3	0= Within range
	1= Outside zero capture range
4	0= Not at center of zero
	1= Center of zero
5	always 1
6	always 1
7	parity

c. Summary of Command and Response:

Command		Response
ASCII	HEX	
W	57	Read scale weight: ①normal data <STX> W ₁ W ₂ <dp>W ₃ W ₄ W ₅ <CR> ②if current weight is invalid <STX>?<Status Byte><CR>
Z	5a	Simulate ZERO key: <STX>?<Status Byte><CR> ;
L	4c	Switch to and send standard weight. Same as W above
K	4b	Switch to and send metric weight. Same as W above
others		Un-known commands: <STX>?<Status Byte><CR>

9. Communication Details when **USER-COM1/2-LAYOUT** is set to *5CP-12*:

- a. This protocol of serial communication is similar to the **NCI3835** protocol. The baud rate and data format is set by User menu.

b. Output status bit meaning:

Bit	Status Byte1	Status Byte2
0	0=Scale in motion	1 = Under capacity
	1=Stable	0 = Not under capacity
1	0= Scale at zero	1 = Over capacity
	1= Not at zero	0 = Not over capacity
2	0=RAM error	1 = ROM error
	1= RAM okay	0 = ROM okay
3	0= EEPROM error	1 = Faulty calibration
	1= EEPROM okay	0 = Calibration okay
4	Always 1	Always 1
5	always 1	always 1
6	always 0	always 0
7	parity	parity

c. Key to symbols used:

<ETX> End of TeXt character (03 hexadecimal).

<LF> Line Feed character (0A hex).

<CR> Carriage Return character (0D hex).

Xxxxxx Weight characters from display including minus sign and out-of-range characters.

p Polarity character (ie '-' for negative, space for positive)

hh Two status bytes. (see 9.b)

UU Units of measure (LB, KG or OZ all upper case).

d. Summary of Command and Response:

Command		Response
ASCII	HEX	
W<CR>	57 0D	Returns decimal lb, kg or oz weight, units and status. <LF>pxxx.xxUU<CR>hh<ETX> Returns ounces weight with units plus scale status. <LF>p00xxxxxOZ<CR>hh<ETX> Scale status only if initial zero error. <LF>hh<CR><ETX>
S<CR>	53 0D	Read scale status : <LF>hh<CR><ETX>
Z<CR>	5A 0D	Simulate ZERO key: no response from scale.
others		Un-known commands: <LF>?<CR>

e. If the indicator is needed to work with UPS worldship, try following settings:

- (1) USER-COM1(or 2)-BAUD.RT=4800
- (2) USER-COM1(or 2)-BYT.FMT=7E1
- (3) USER-COM1(or 2)-LAYOUT=SCP-12
- (4) Set scale port to NCI3835 in UPS worldship.

5. Calibration

Note:

- ① Before calibrating the scale, prepare a standard weight (more than 10% of FS weight) for calibration.
 - ② In the following steps, pressing **ZERO/ON/OFF** will show “E11.1P”, and pressing **ZERO/ON/OFF** again or pressing **TARE/PRESET** will exit the calibration
1. Go to setup mode, select “CAL”, then press **TARE/PRESET** to confirm to enter calibration mode.
 2. After entering this mode, the number times that the indicator has been calibrated will be shown first, this number will increased after every calibration and the calibration data will be saved. This counter cannot be modified or erased by any other way, it counts from 0000 to 9999, and when it reaches 9999, it will start over at 0000. After the counter number is displayed, it will show “CAL.0FF” or “CAL.0N” according to the status of the sealed calibration switch is OFF or ON. If the switch is OFF, the following steps can be completed, but the result will not be saved. Press **TARE/PRESET** key to continue.
 3. When “ERR0” is shown, use \uparrow \downarrow key to select ERR0 to perform zero point calibration (refer to step 4), L, PE to perform linearity calibration (refer to step 5), GE0 to perform Geographical calibration (refer to step 6) or INPUT to input/view calibration parameters (refer to step 7).

● ZERO Calibration

4. When ERR0 is selected, remove all weight from the scale and press the **TARE/PRESET** key to confirm, the ERR0 will flash when it is in the catching zero point state. After receiving reasonable data, it will automatically continue to step 8.

● Linearity Calibration

5. When L, PE is selected, press **TARE/PRESET** key to enter linearity calibration.
 - a. 0% weight will be displayed after CAL.P0 is shown, remove all weight from the scale and then press **TARE/PRESET** to confirm to calibrate the zero point; the zero weight will flash in catching zero point state. After calculating the reasonable zero-point data, the zero weight will become steady.
 - b. When the first default standard weight is displayed after CAL.P1 is shown, it will be calibrated on standard weight for the first point. Place the corresponding weight (more than 10%FS weight) onto the scale. The default standard weight is 100%FS. Use \uparrow \downarrow \rightarrow keys to input the value of the loaded weight. Before entering this value, you can press and hold the **UNIT/DATA** key to change the unit of measure to kg or lb. Press **TARE/PRESET** key to confirm, then the indicator will flash the input standard weight. When this weight number becomes steady, it means the stable and reasonable data corresponding to the standard weight has been received. After this, the indicator will automatically continue to the next step. If this point

cannot be calibrated correctly (E.g. the weight load on the scale is too small, the input data is incorrect...), it will display “CAL.Er” and return to **step a** for re-calibration.

- c. When $E\pi d.Y$ is shown and y is flashing, enter a command to exit calibration or go on to the next calibration. Use \uparrow \downarrow key to select YES or NO , use $\boxed{TARE/PRESET}$ to confirm. If YES is selected, you will be directed to step 8 to end calibration; if NO is selected, continue to the next step.
- d. When 100%FS weight is displayed after $CAL.P2$ is shown, it will be calibrated on standard weight for the second point. Place corresponding weight (more than 10%FS weight, and larger than the weight used on $CAL.P1$) onto the scale. The next operation steps are the same as explained in **step b**.
- e. When $E\pi d.Y$ is shown and Y is flashing, Use \uparrow \downarrow key to select YES or NO , use $\boxed{TARE/PRESET}$ to confirm. Refer to **step c** for more details.
- f. When the third standard weight displayed after $CAL.P3$ is shown, it will be calibrated on standard weight for the third point. Place corresponding weight (more than 10%FS weight, and larger than the weight used on $CAL.P2$) onto the scale. The next operation steps are the same as explained in step b.
- g. When the stable and reasonable data corresponding to the standard weight has been received, the indicator will automatically go to Step8. Otherwise, it will display “CAL.Er” and return to the previous steps.

● GEO Calibration

6. When $GE\Delta$ is selected, press $\boxed{TARE/PRESET}$ key to confirm to enter Geographical Adjustment. When “CODE” is shown, use \uparrow \downarrow keys to select geographical position code or input the local gravity value directly.
 - a. When $CODE$ is selected, select the position code of the scale being used ($00-70$) according to the elevation and latitude from Table6-1 by using the \uparrow \downarrow \rightarrow keys. Press $\boxed{TARE/PRESET}$ key to confirm.
 - b. When $GRAVITY$ is selected, use the \uparrow \downarrow \rightarrow keys to input the gravity value of the position that the scale is used ($9.76183-9.99999$). Press $\boxed{TARE/PRESET}$ key to confirm.

NOTE: Only an authorized manufacturer’s representative or certified verification personnel may make these changes. Changing the geographical setting alters the calibration values !!!

● Input Calibration

7. When $INPUT$ is selected, press $\boxed{TARE/PRESET}$ key to confirm to enter Input calibration, to view parameters value that were calibrated before, or to view current calibration parameters value.
 - a. All parameters about calibration are divided to 18 pages to be displayed on LCD by “nn:xxxx” format (“nn” is a decimal number of page, “xxxx” is an hexadecimal value of parameter, e.g.

02:85E2).

01-02 pages: zero code;

03-04 pages: standard weight of *CAL.P 1*;

05-06 pages: codes of *CAL.P 1*;

07-08 pages: standard weight of *CAL.P 2*;

09-10 pages: codes of *CAL.P 2*;

11-12 pages: full capacity net code;

13-14 pages: the coefficient of weight fine-tune;

15-16 pages: gravity value of calibration location;

17-18 pages: gravity value of the location that the scale is used at.

- b. When there is no digit blinking on the LCD, this means the calibration parameters value are being viewed, and use the **UNIT/DATA** key to view the next page, use the **HOLD/SETUP** key to return to last sub-menu, or use the **ZERO/ON/OFF** key to exit.
 - c. When parameters value are being viewed, use the **UNIT/DATA** key to prepare to modify. When the first displayed digit is blinked, this means the value is being modified. Use the **UNIT/DATA** key to make the next digit flash (if current flashing position is the last one, next page value will be shown), use the **↑ ↓ →** key to input number, use the **TARE/PRESET** key to confirm.
 - d. In this mode, press and hold the **PRINT/FUNC** key for more than 4 seconds for these parameters to be sent out. The print out format is <LF>nn:xxx<CR>; there are a total of eighteen lines.
8. After the indicator receives all the necessary data, it will calculate and store all calibration parameters into EEPROM, and after finishing the calibration it will display *CAL.END*. Then, it will re-start and return to original mode.

TABLE6-1: Location Code for different elevation and latitude

elevation(km) latitude(°)	0	0.2	0.4	0.6	0.8	1	1.2	1.4	1.6	1.8	2	2.2	2.4	2.6	2.8	3	3.2	3.4	3.6	3.8	4	4.2	4.4	4.6	4.8	5	5.2	5.4	5.6	5.8	6																																																																														
0	19	18	17	17	16	15	15	14	14	13	12	12	11	10	10	9	9	8	7	7	6	6	5	4	4	4	3	2	2	1	1	0																																																																													
3	19	18	17	17	16	16	15	14	14	13	12	12	11	11	10	9	9	8	8	7	6	6	5	4	4	4	3	3	2	1	1	0																																																																													
6	19	18	18	17	17	16	15	15	14	14	13	12	12	11	10	10	9	9	8	7	7	6	6	5	4	4	4	3	2	2	1	1	0																																																																												
9	20	19	19	18	17	17	16	15	15	14	14	13	12	12	11	11	10	9	9	8	7	7	6	6	5	4	4	3	2	2	1	1	0																																																																												
12	21	20	20	19	18	18	17	16	16	15	15	14	13	13	12	11	11	10	10	9	8	8	7	7	6	5	5	4	3	3	2	2	1	0																																																																											
15	22	21	21	20	20	19	18	18	17	16	16	15	15	14	13	13	12	11	11	10	10	9	8	8	7	7	6	5	5	4	3	3	2	1	0																																																																										
18	23	23	22	22	21	20	20	19	19	18	17	17	16	15	15	14	14	13	12	12	11	10	10	9	9	8	7	7	6	6	5	4	3	2	1	0																																																																									
21	25	25	24	23	23	22	21	21	20	20	19	18	18	17	16	16	15	15	14	13	13	12	12	11	10	10	9	8	8	7	7	6	5	4	3	2	1	0																																																																							
24	27	26	26	25	25	24	23	23	22	21	21	20	20	19	18	18	17	17	16	15	15	14	13	13	12	12	11	10	10	9	9	8	7	6	5	4	3	2	1	0																																																																					
27	29	29	28	27	27	26	25	25	24	24	23	22	22	21	21	20	19	19	18	17	17	16	16	15	14	14	13	12	12	11	11	10	10	9	8	7	6	5	4	3	2	1	0																																																																		
30	31	31	30	30	29	28	28	27	26	26	25	25	24	23	23	22	22	21	20	20	19	18	18	17	17	16	15	15	14	14	13	12	11	11	10	9	8	7	6	5	4	3	2	1	0																																																																
33	34	33	33	32	31	31	30	30	29	28	28	27	26	26	25	25	24	23	23	22	21	21	20	20	19	18	18	17	17	16	15	14	13	12	11	11	10	9	8	7	6	5	4	3	2	1	0																																																														
36	36	36	35	34	34	33	33	32	31	31	30	30	29	28	28	27	26	26	25	25	24	23	23	22	22	21	21	20	20	19	18	18	17	16	15	14	13	12	11	11	10	9	8	7	6	5	4	3	2	1	0																																																										
39	39	38	38	37	36	36	35	35	34	33	33	32	32	31	30	30	29	28	28	27	27	26	25	25	24	24	23	23	22	22	21	21	20	19	18	18	17	16	15	14	13	12	11	11	10	9	8	7	6	5	4	3	2	1	0																																																						
42	42	41	40	40	39	39	38	37	37	36	35	35	34	34	33	32	32	31	31	30	29	29	28	27	27	26	26	25	24	24	23	23	22	21	21	20	19	18	17	16	15	14	13	12	11	11	10	9	8	7	6	5	4	3	2	1	0																																																				
45	44	44	43	42	42	41	41	40	39	39	38	38	37	36	36	35	34	34	33	33	32	31	31	30	30	29	28	28	27	27	26	26	25	24	24	23	23	22	21	21	20	19	18	17	16	15	14	13	12	11	11	10	9	8	7	6	5	4	3	2	1	0																																															
48	47	46	46	45	45	44	43	43	42	41	41	40	40	39	38	38	37	37	36	35	35	34	33	33	32	32	31	31	30	30	29	29	28	28	27	27	26	26	25	24	24	23	23	22	21	21	20	19	18	17	16	15	14	13	12	11	11	10	9	8	7	6	5	4	3	2	1	0																																									
51	50	49	48	48	47	47	46	45	45	44	44	43	42	42	41	40	40	39	39	38	37	37	36	36	35	34	34	33	33	32	32	31	31	30	30	29	29	28	28	27	27	26	26	25	24	24	23	23	22	21	21	20	19	18	17	16	15	14	13	12	11	11	10	9	8	7	6	5	4	3	2	1	0																																				
54	52	52	51	50	50	49	49	48	47	47	46	46	45	44	44	43	42	42	41	41	40	39	39	38	38	37	37	36	36	35	35	34	34	33	33	32	32	31	31	30	30	29	29	28	28	27	27	26	26	25	24	24	23	23	22	21	21	20	19	18	17	16	15	14	13	12	11	11	10	9	8	7	6	5	4	3	2	1	0																														
57	55	54	54	53	52	52	51	51	50	49	49	48	47	47	46	46	45	44	44	43	43	42	41	41	40	39	39	38	38	37	37	36	36	35	35	34	34	33	33	32	32	31	31	30	30	29	29	28	28	27	27	26	26	25	24	24	23	23	22	21	21	20	19	18	17	16	15	14	13	12	11	11	10	9	8	7	6	5	4	3	2	1	0																										
60	57	57	56	55	55	54	54	53	52	52	51	51	50	49	49	48	47	47	46	46	45	44	44	43	42	42	41	41	40	40	39	39	38	38	37	37	36	36	35	35	34	34	33	33	32	32	31	31	30	30	29	29	28	28	27	27	26	26	25	24	24	23	23	22	21	21	20	19	18	17	16	15	14	13	12	11	11	10	9	8	7	6	5	4	3	2	1	0																					
63	60	59	58	58	57	56	56	55	55	54	53	53	52	52	51	50	50	49	48	48	47	47	46	45	45	44	44	43	43	42	42	41	41	40	40	39	39	38	38	37	37	36	36	35	35	34	34	33	33	32	32	31	31	30	30	29	29	28	28	27	27	26	26	25	24	24	23	23	22	21	21	20	19	18	17	16	15	14	13	12	11	11	10	9	8	7	6	5	4	3	2	1	0																
66	62	61	60	60	59	59	58	57	57	56	56	55	54	54	53	52	52	51	51	50	49	49	48	47	47	46	45	45	44	44	43	43	42	42	41	41	40	40	39	39	38	38	37	37	36	36	35	35	34	34	33	33	32	32	31	31	30	30	29	29	28	28	27	27	26	26	25	24	24	23	23	22	21	21	20	19	18	17	16	15	14	13	12	11	11	10	9	8	7	6	5	4	3	2	1	0													
69	64	63	62	62	61	61	60	59	59	58	57	57	56	56	55	54	54	53	53	52	51	51	50	49	49	48	48	47	47	46	46	45	45	44	44	43	43	42	42	41	41	40	40	39	39	38	38	37	37	36	36	35	35	34	34	33	33	32	32	31	31	30	30	29	29	28	28	27	27	26	26	25	24	24	23	23	22	21	21	20	19	18	17	16	15	14	13	12	11	11	10	9	8	7	6	5	4	3	2	1	0								
72	65	65	64	63	63	62	62	61	60	60	59	59	58	57	57	56	55	55	54	54	53	52	52	51	51	50	49	49	48	48	47	47	46	46	45	45	44	44	43	43	42	42	41	41	40	40	39	39	38	38	37	37	36	36	35	35	34	34	33	33	32	32	31	31	30	30	29	29	28	28	27	27	26	26	25	24	24	23	23	22	21	21	20	19	18	17	16	15	14	13	12	11	11	10	9	8	7	6	5	4	3	2	1	0					
75	67	66	66	65	64	64	63	62	62	61	61	60	59	59	58	58	57	56	56	55	54	54	53	53	52	51	51	50	49	49	48	48	47	47	46	46	45	45	44	44	43	43	42	42	41	41	40	40	39	39	38	38	37	37	36	36	35	35	34	34	33	33	32	32	31	31	30	30	29	29	28	28	27	27	26	26	25	24	24	23	23	22	21	21	20	19	18	17	16	15	14	13	12	11	11	10	9	8	7	6	5	4	3	2	1	0			
78	68	67	67	66	66	65	64	64	63	62	62	61	61	60	60	59	59	58	58	57	56	56	55	54	54	53	53	52	51	51	50	49	49	48	48	47	47	46	46	45	45	44	44	43	43	42	42	41	41	40	40	39	39	38	38	37	37	36	36	35	35	34	34	33	33	32	32	31	31	30	30	29	29	28	28	27	27	26	26	25	24	24	23	23	22	21	21	20	19	18	17	16	15	14	13	12	11	11	10	9	8	7	6	5	4	3	2	1	0
81	69	68	68	67	67	66	65	65	64	63	63	62	62	61	61	60	60	59	59	58	57	57	56	55	55	54	54	53	53	52	51	51	50	49	49	48	48	47	4																																																																						

6. MISC

View ADC output Code

In this mode, you can examine the stability of the weighing system, which is the increment value of the ADC output code corresponding to the loaded weight.

Note:

- ① The increment of ADC code for FS weight must be larger or equal to 10 times of the selected display division; otherwise, the calibration cannot be properly completed. E.g. The display division is 0.1kg. Load 100kg standard weight on the platform, the increment of ADC code should be at least more than $10 \times 100\text{kg} / 0.1\text{kg} = 10 \times 1000 = 10000$. In this case, the scale can be calibrated. Otherwise, a smaller division needs to be chosen.
 - ② The variation of the ADC code should be small; otherwise, the calibration cannot be properly completed.
1. To enter this working mode, press and hold the **HOLD/SETUP** key until $C \square \Pi F, \bar{G}$ is shown, using $\leftarrow \uparrow \downarrow \leftarrow \lrcorner$ keys to go to $\bar{n}, \bar{5}C - C \square dE$ item, then press the **TARE/PRESET** to enter this mode and display ADC output raw code.
 2. In this mode, first press the **TARE/PRESET** key to set current code as a reference zero, and then to display net code, press the **TARE/PRESET** again to clear this reference and display gross code. In display net code mode, press the **ACC/TOTAL** key to select net or gross code to display, but not to clear the reference code..
 3. In this mode, press the **UNIT/DATA** key to select displaying code that has been filtered by no-filter, filter1 or filter1 and filter2, and corresponding annunciator **LO, OK, HI** will be lighted.
 4. Press the **HOLD/SETUP** key to return to last menu item, press the **ZERO/ON/OFF** key to exit .

View or Calibrate Power Voltage

In this mode, you can examine the voltage of battery, or you can examine the voltage that regulated out from the AC adaptor when batteries are not used, or you also can calibrate the displayed voltage and set the voltage value of low battery point.

Note:

- ① The end customer normally does not need to calibrate the displayed voltage, these calibrations have been done in the factory.
 - ② The normal displaying voltage is 4.0V-6.0V
1. To enter this working mode, press and hold the **HOLD/SETUP** key until $C \square \Pi F, \bar{G}$ is shown, using $\leftarrow \uparrow \downarrow \leftarrow \lrcorner$ key to go to $\bar{n}, \bar{5}C - \bar{u} \square L$ item, press the **TARE/PRESET** to enter this mode and display battery voltage.
 2. If the voltage is not correct, refer to the following steps to calibrate the voltage:
 - a. Prepare a DC power supply which output voltage can be adjusted from 5V to 8V, output

current must be larger than 0.5A. Power off the indicator, remove the AC adaptor, connect the DC power to battery connector on main board, adjust voltage to about 5V, power on the indicator, and then enter into battery voltage display mode.

- b. Press and hold **UNIT/DATA** key until $CAL.5V$ is shown, adjust voltage to 5V, press **TARE/PRESET** key to confirm 5V calibration.
 - c. When $CAL.6V$ is shown, adjust voltage to 6V, press **TARE/PRESET** key to confirm 6V calibration. When END is shown, that means the voltage calibration is completed and then exit to display voltage.
3. Press **HOLD/SETUP** key to return to last menu item, press **ZERO/ON/OFF** key to prepare to exit.

View or Set Date

1. After entering **SETUP** mode (by pressing and holding the **HOLD/SETUP** key for more than 4 seconds), using the \leftarrow \uparrow \downarrow \leftarrow keys to select $DATE$ item, then press the **TARE/PRESET** key to display current time.
2. Date display Format is: xx.xx.xx(yy-mm-dd)
3. Press and hold the **UNIT/DATA** key for more than 4 seconds to enter modification date mode. Using the \uparrow \downarrow \rightarrow \leftarrow keys to modify current date. If inactivity exceeds 5 seconds, it will automatically exit modification mode.
4. Press the **HOLD/SETUP** key to return to the last menu item, press the **ZERO/ON/OFF** key to exit.

View or Set Time

1. After entering **SETUP** mode (by pressing and holding the **HOLD/SETUP** key for more than 4 seconds, using the \leftarrow \uparrow \downarrow \leftarrow keys to select $TIME$ item, then press the **TARE/PRESET** key to display current time.
2. Time display Format is: xx:xx:xx (hh-mm-ss), 24h format
3. Press and hold the **UNIT/DATA** key for more than 4 seconds to enter modification time mode. Using the \uparrow \downarrow \rightarrow \leftarrow keys to modify current time. If inactivity exceeds 5 seconds, it will automatically exit modification mode.
4. Press the **HOLD/SETUP** key to return to the last menu item, press the **ZERO/ON/OFF** key to exit.

View Firmware Version

1. Press and hold the **HOLD/SETUP** key until **CONFIG** is shown, using the \leftarrow \uparrow \downarrow \leftarrow keys to select VER item, then press **TARE/PRESET** to display current Version.
2. Firmware Version display Format is: $xx.yy$, xx is hardware version, yy is software version.
3. Press the **HOLD/SETUP** key to return to the last menu item, press the **ZERO/ON/OFF** key to exit.

7. TEST

Display Test

1. Press and hold the **HOLD/SETUP** key for more than 4 seconds to enter **SETUP** mode, using \leftarrow \uparrow \downarrow \leftarrow keys to select *TEST-DSP.TST* item, then press **TARE/PRESET** to enter test display mode and all segments will be lit first.
2. In this mode, every pressing of **ACC/TOTAL** key will light the next segment, every pressing of **UNIT/DATA** will light the next digit, and pressing the **PRINT/FUNC** key will automatically light all segments and all digits.
3. Press the **HOLD/SETUP** key to return to the last menu item, press **ZERO/ON/OFF** key to exit.

Serial Port1/2 (COM1/2) Receiving Test

1. Before testing the receiving function of **COM1** or **COM2**, a cable is needed to connect a PC and the indicator, and software similar to Super Terminal of Windows is needed to run on the PC to send bytes to the indicator. Please note: baud rate is selected by **USER-COM1/2-BAUDRT, 8N1 byte format is fixed**, Hex data (0x00 – 0xff) are used.
2. Press and hold the **HOLD/SETUP** key for more than 4 seconds to enter **SETUP** mode, using \leftarrow \uparrow \downarrow \leftarrow keys to select *TEST-COM1.rd* or *TEST-COM2.rd* item, then press the **TARE/PRESET** key to enter test COM1/2 receiving function, and *rd l. --* or *rd2. --* will be displayed.
3. In this mode, received hex data (0x00 – 0xff) will be displayed on -- position.
4. Press the **HOLD/SETUP** key to return to last menu item, press the **ZERO/ON/OFF** key to exit.

Serial Port1/2(COM1/2) Transmitting Test

1. Before testing the transmitting function of **COM1** or **COM2**, a cable is needed to connect a PC and this instrument, and a software similar to Super Terminal of Windows is also needed to run on the PC to receive bytes from this instrument. Please note: baud rate is selected by **USER-COM1/2-BAUDRT, 8N1 byte format is fixed**, Hex data (0x00 – 0xff) are used.
2. Press and hold the **HOLD/SETUP** key for more than 4 seconds to enter **SETUP** mode, using \leftarrow \uparrow \downarrow \leftarrow keys to select *TEST-COM1.td* or *TEST-COM2.td*, then press the **TARE/PRESET** key to enter test COM1/2 transmitting function, *td l--* or *td2--* will be displayed.
3. In this mode, transmitted hex data (0x00 – 0xff) will be displayed on -- position, use \uparrow \downarrow \rightarrow \leftarrow keys to modify transmitted data.
4. Press the **HOLD/SETUP** key to return to last menu item, press the **ZERO/ON/OFF** key to exit.

Keyboard and Buzzer Test

1. Press and hold the **HOLD/SETUP** key for more than 4 seconds to enter **SETUP** mode, using the \leftarrow \uparrow \downarrow \leftarrow keys to select *TEST-BEEP.TST* item, then press the **TARE/PRESET** key to enter test keypad mode, and *BEY. --* will be displayed.
2. In this mode, press a key, the value of this key will be displayed on -- position and buzzer will beep depending on what the **USER-BEEP-KEY** item is set to.
3. Press the **HOLD/SETUP** key to return to the last menu item, press **ZERO/ON/OFF** key to exit.

8. Connectors and Jumpers

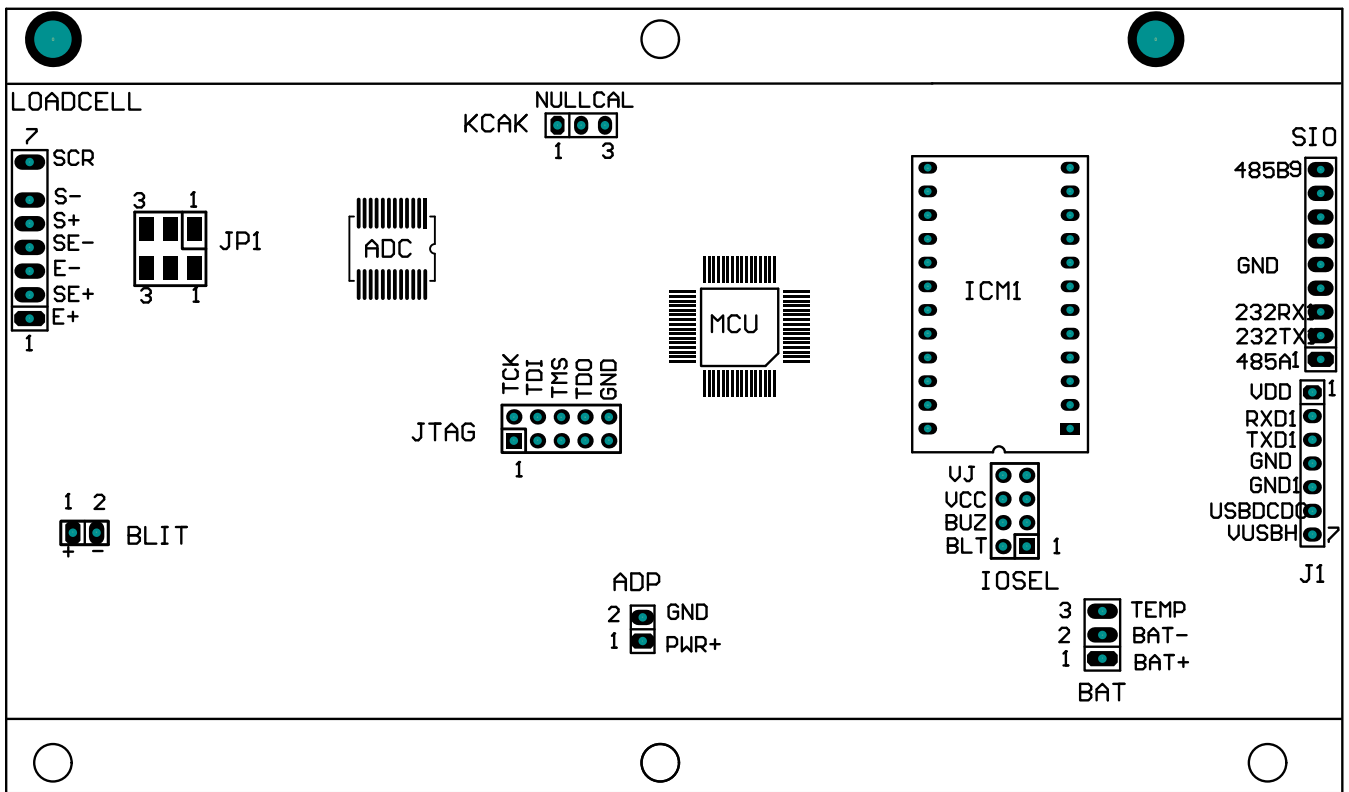

1. Load Cell Connector

PIN #	DEFINITION	IN/OUT/POWER	ELECTRICAL LEVEL
1	Excitation +	Power output	5±0.3 Vdc (≤0.12A)
2	Sense +	Power input	5±0.3 Vdc
3	Excitation-	Power ground	0Vdc
4	Sense -	Power input	≤0.5 Vdc
5	Signal +	Signal Input	2.5±0.3 Vdc
6	Signal -	Signal Input	2.5±0.3 Vdc
7	Shield	-	-

2. ADP---Adapter Power Input Connector

PIN #	DEFINITION	IN/OUT/POWER	ELECTRICAL LEVEL
1	Adapter input voltage +	Power input	6.5Vdc(6-9Vdc,≥0.5A)
2	Adapter input voltage – (GND)	Power ground	0Vdc

3. BAT---Battery Power Input Connector

PIN #	DEFINITION	IN/OUT/POWER	ELECTRICAL LEVEL
1	Battery input voltage +	Power input	4-6.8Vdc
2	Battery input voltage – (GND)	Power ground	0Vdc
3	Temperature sensor on Battery input	Power ground	

4. SIO---Serial Input Output Connector

PIN #	DEFINITION	IN/OUT/POWER	ELECTRICAL LEVEL
1	RS485 signal A (if RS485 installed)	Input/output	0-5Vdc
2	RS232 Transmit on UART0	Output	-12 to +12Vdc
3	RS232 Receive on UART0	Input	-12 to +12Vdc
4			
5	GND	Power ground	0Vdc
6			
7			
8			
9	RS485 signal B (if RS485 installed)	Input/output	0-5Vdc

5. J1---USB Connector for virtual RS232 #1 and USB power supply

PIN #	DEFINITION	IN/OUT/POWER	ELECTRICAL LEVEL
1	VDD	Power output	5±0.3 Vdc
2	RXD Receive on UART1	Input	0-5Vdc
3	TXD Transmit on UART1	Output	0-5Vdc
4	GND of VDD	Power ground	0Vdc
5	GND1 of VUSBH	Power ground	0Vdc
6	USB Power DC/DC select	Output	0-5Vdc
7	USB Power DC/DC output	output	6±0.3 Vdc

6. KCAK Jumper set:

CONNECTED PINS	FUNCTION
1-2	Calibration enabled
2-3	Calibration disabled

7. JP1 Jumper:

CONNECTED PINS	FUNCTION
1-2	Two shorter on pin1-2: 4 wires load cell is used
2-3	Two shorter on pin2-3: 6 wires load cell is used

9. Definitions

Symbol Definitions

- CAP.---* - Next displaying content is capacity
- CALON* - Calibration seal switch is on ON position
- CALPx* - Calibration on point(x)
- CALEND* - Calibration is end
- CONP* - To go to input COMPARE data mode
- HIGH* - To input HIGH limitation data of comparison
- LOW* - To input LOW limitation data of comparison
- TARE* - To preset TARE weight
- SPLL* - Sample load weight of low point
- SPLH* - Sample load weight of high point
- SPLPE* - Sample goods weight to calculate piece weight
- INPCS* - Input pieces number of weighted goods
- SPLPE* - Sample goods weight to calculate unit percent weight
- INPPE* - Input percentage of weighted goods
- ACC. xxx* - Accumulation times is xxx

10. Troubleshooting

SYMPTOM	PROBABLE CAUSE	REMEDY
Does not turn on.	<ol style="list-style-type: none"> 1. AC adapter is not connected securely 2. Low battery 3. Indicator is damaged 	<ol style="list-style-type: none"> 1. Re-plug the AC adapter or rotate the plug to securely connect it to the scale 2. Replace the batteries 3. Replace with a new indicator and perform calibration
<i>Ad</i> -----	<ol style="list-style-type: none"> 1. The cable from platform to indicator is not correctly connected, or disconnected, or short circuit 2. Indicator is damaged 3. Load cell cable is broken 4. Load cell is damaged 	<ol style="list-style-type: none"> 1. Check the cable or replace with a new cable. 2. Replace with a new indicator and perform calibration. 3. Open the junction box to check whether all the wires are securely connected. If any wire are loosen from terminal blocks, connect the wire. 4. Return the scale for repair.
<i>Ad</i> -----		
<i>0</i> -----	<ol style="list-style-type: none"> 1. Weight reading exceeds Power On Zero limit 2. Indication is out of key zero range 	<ol style="list-style-type: none"> 1. Ensure the scale platform is empty 2. Perform zero calibration. 3. Reduce the weight on the platform until the indication is within the key zero range
<i>0</i> -----	Weight reading below Power On Zero limit	<ol style="list-style-type: none"> 1. Install platform on the scale 2. Check whether an object stuck between the load cell and scale base, if yes, remove the object 3. Perform zero calibration
-----	<ol style="list-style-type: none"> 1. Weight reading exceeds Overload limit; 2. The weight value cannot be displayed in the current unit of measure because it exceeds 6 digits 	<ol style="list-style-type: none"> 1. Reduce load on scale until the weight value is displayed 2. Use a more appropriate unit of measure
-----	Weight reading below Under load limit	<ol style="list-style-type: none"> 1. Install platform on scale 2. Perform zero calibration
<i>EEPE1</i>	<ol style="list-style-type: none"> 1. CONFIG parameters are not correctly set 2. CAL parameters are not correctly set 	<ol style="list-style-type: none"> 1. Re-set CONFIG parameters per the Technical Manual 2. Perform calibration
<i>EEPE2</i>	USER parameters are not correctly set	Re-set USER parameters per the Technical Manual
<i>CALEr</i>	<ol style="list-style-type: none"> 1. Input data or loaded weight is too small, too big 2. Weight signal is unstable, un-linear 	<ol style="list-style-type: none"> 1. Input correct data, load correct weight onto platform 2. Return the scale for repair
<i>StbEr</i>	When in HOLD mode, weighing object cannot become stable in 9 seconds, and the weight variation is more than 5d	<ol style="list-style-type: none"> 1. Stabilize the object 2. Set a larger HOLD parameter "<i>HLd-rnG</i>"
Cannot zero the display	<ol style="list-style-type: none"> 1. Load on scale exceeds allowable limits (2%FS) 2. Load on the scale is unstable 	<ol style="list-style-type: none"> 1. Remove load on scale 2. Wait for load to become stable, then press the ZERO/ON/OFF key to zero the display

SYMPTOM	PROBABLE CAUSE	REMEDY
<i>P</i> <u><i>y</i></u> <i>L</i> <u><i>e</i></u> <i>r</i>	Piece weight error; the weight on the platform is too small (<0.5 d) to define a valid reference weight	Use a greater weight for the sample
1. Max. CAPACITY is not same as marked on overlay 2. Any function invalid 3. Any measuring units missed	CONFIG parameters are not correctly set	Re-set CONFIG parameters per the Technical Manual
Incorrect counting result or percent weighing result when using SPL to enter a piece weight or unit-percent weight	1. Sampling quantity is too small 2. Calculated piece weight or unit-percent weight is a little different from the real value	Increase the sampling quantity
Weighing is not accurate	1. An object is stuck between load cell and scale base 2. Load cell received a heavy impact 3. The scale is in an location far away from Chicago	1. Remove the object. 2. Perform Linear calibration 3. Perform GEO calibration
Battery symbol is empty or <i>L</i> <u><i>o</i></u> <i>b</i> <u><i>A</i></u> <i>t</i>	Low battery	Replace batteries