

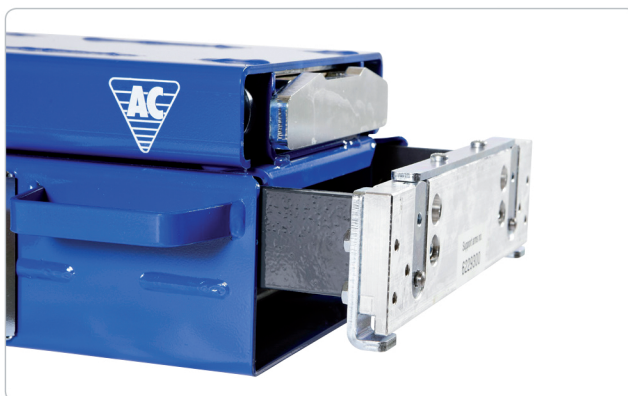

AC Hydraulic<sup>A/S</sup>  
NO COMPROMISE

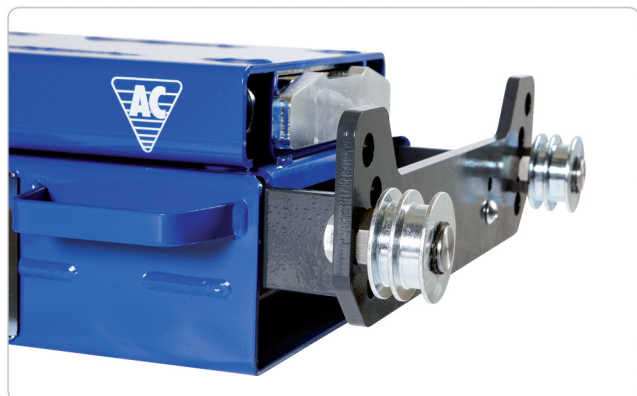

**SD20L/SD26L**  
**SD20PHL/SD26PHL**  
**SD20PHL-A/SD26PHL-A**

**DK** Ophængsliste for saksedonkrafte

Lift	Model, type, (evt. årgang og andre bemærkninger)	Varenr.
Lift	Model, Type, (Year and other comments)	Item No.
Hebe- bühne	Modell, Typ, (Baujahr und weitere Hinweise)	Artikel Nr.
Pont	Modèle, Marque (année et d'autres remarques)	Référence
Autec	3044, 4044	62 262 00
ATH Heini	ATH 4.35A,ATH4.55A,ATH 4.35,ATH 4.55 (production 2013)	62 276 00
	ATH SH5000HA (production 2013)	62 354 00
AGM	M40, M45	62 270 00
ATT	AD H2 034 A, 3500 PH Accura 4700 mm	62 268 00
	HYMAX 5000 II	62 270 00
Autop	2.30, F 420 **)	62 270 00
	2.40 F460	62 264 10
	Masterlift, Quattrolift, 4.60 F550 (Biglift), Profilift 2,4F, Profilift 2,4FN 460	62 264 00
Beissbarth	R420, R435	62 262 00
	BC 345	62 289 00
	Romeico 440	62 359 00
Bima	50	62 283 00
Bradbury	410, 414, 420, 424, 434	62 265 00
	"Flush-Fitt" modeller, models, Modellen, modèles	62 273 00
Cascos	C425, C444, C445, C450, C443 (standard) (med opbukket kant, with bent up edges, mit hochgebogener Kante, avec bord plié)	62 262 00
	C440, C444, C445, C450 (uden opbukket kant, without bent up edges, ohne hochgebogener Kante, sans bord plié)	62 265 00
	C441, C442, C443 (MOT), C445H	62 273 00
Consul	4.35 (H 152) (med opbukket kant, with bent up edges, mit hochgebogener Kante, avec bord plié)	62 262 00
	4.40 AF/AFK	62 273 00
	0.35 S/SN , 4.40 AF/SN-AM-DC, 4.40 A/K H 233, 4.4 K-SN, 4.40L	62 284 00
	H 192	62 352 00
	4.50	62 357 00
	4.60	62 275 00
Corgi	Erco 4400	62 272 00
Effemme	Power Up 45 (low profile), Power Up 50 (standard)	62 298 00
ETG		62 472 00
FOG	403, 404, 490, 495, 497, 499	62 359 00
	493 Quadra	62 283 00
	493 Quadra m lys, w. lights, mit Licht, avec éclairage	62 286 00
	494 Levithan	62 265 00
	4949001	62 286 00
Hermann	Aulutrack 4,50 & 4,60	62 293 00
Hofmann	Europalift, Europa IV, Quattrolift 3500	62 359 00
	Multilift PSVWT 4B *)	62 280 00
	Multilift 4000	62 343 00
	Service lift 4000, 5000, Quattrolift 4000 SL *)	62 280 00
HPA	P4C WLCT	62 465 40
Hunter	RX40	62 353 00
IME	HVS35	62 262 00

Intertech	HH 440, INT. 435 I	62 359 00
	INT. 4400	62 262 00
	INT. 4352, 4402	62 263 00
	INT. 4401, 4404, 4407 , 450 N/5	62 270 00
	INT. 4600 ( 62.258.00 + 4x62.257.00; hvis variabel, when adjustable, fals variabel, si réglable )	62 265 00
Istobal	42721, 42722, 42724, 42725, 42727, 4 EDO-100-151-300-351-600	62 262 00
	4 EDO 400-500	62 270 00
John Bean	JBC WA 2,0 –WA 4,0 *)	62 280 00
	48109B (hjul justering, wheel alignment, Rad Justierung, plaques de réalignement)	62 356 00
Launch	TLT 440, TLT 440 W, TLT 455W	62 280 00
Maha	DUO, DUO + I, Matop, Servicelift	62 293 00
	Carlifit II 3,5 Alu./Stahl	62 355 00
	Carlifit 4, Carlifit 4, I	62 270 00
	Carlifit II 4,0	62 355 00
	ZS Square 3.5	62 293 00
Maic (Giuliano, Silver)	3500, 3600, 4000, 4200, 5000	62 280 00
	3500, 3600, 4000, 4200, 5000 (med lys, with light, mit Licht, avec éclairage)	62 283 00
Mondolfo	TITAN X 573LT	62 293 00
	TITAN X443 (LT)L	62 272 00
Molnar	4488S, 4488W	62 269 00
Nordlift	UC-3500	62 359 00
	UC-4000	62 356 10
	UC-5000	62 262 00
Nußbaum	Combilift 4.32 H, 4.35 H, 4.40 H, 4.50 H & 4.65 H (til, until, bis, jusqu'à april 2009), 4.80 H	62 283 00
****)next page	4.65 H, 4.80 H	62 268 00
	Unilift 3000	62 475 00
	Unilift 3500 CLT/NT + 5000 NT, 3500NT PLUS, 5000NT, (uden lys, without light, ohne Licht, sans éclairage)	62 268 00
	Unilift 3500, Unilift 5000	62 283 00
	Unilift 3500 NT/CLT fra/von/from/de 04/2013, Unilift 5000 NT/CLT fra/von/from/de 04/2013	62 481 00
	Unilift 5000 CCT PLUS QUATRO SST, QUATRO CLT 3,5 t	62 344 00
	Unilift 4000, Unilift 3200, Unilift 3000, 4.40H (til, until, bis, jusqu'à 2001)	62 274 00
	4.30 H	62 275 00
	Toplift 2,32/2,35 TSA	62 341 00
	4.40H, 4.45H, 4.45HN, 4.50H	62 346 00
	4.40H-ND	62 346 50
	OMA	520, 521, 522, 525, 526, 527, 527A
523,439		62 359 00
524, 524A, 527R **)		62 270 00
528, 526 LT ( 62.258.00 + 4x62.257.00; hvis variabel, when adjustable, fals variabel, si réglable )		62 265 00
Stelth 40		62 355 00
OMCN	399	62 359 00
	400 (med lys, with light, mit Licht, avec éclairage)	62 263 20
	400, 401, 401LS, 402, 402LS, 403LS	62 472 00
	405	62 352 00
Omer	VEGA 35, 35LT, 50, Fox 36R	62 283 00
	VEGA 30	62 273 00
	Viva 50	62 280 00
	Kar 45	62 270 00
	Stelth 40	62 355 00
Pro-lift	MAS 0.45 LT Bridge	62 289 00
Provac	FS40	62 353 00
Orlandini	101, 102, 104	62 359 00

Ravaglioli	RAV 404, 410, 421, 420 NI (med opbukket kant, with bent up edges, mit hochgebogener Kante, avec bord plié)	62 262 00
	RAV 422, 4250, 4350, 4251, 4252, 4351 (til, until, bis, jusqu' 2007)	62 270 00
	(uden kant, without bent up edges, ohne Kante, sans bord plié)	
	(4401, 4402 - nogle få førsteudgaver, for few first editions, für einige Erstaubgaben, quelques un des premiers modèles)	
	RAV 4401, 4402, 4405, 4406, 4300, 4350, 4351, 4400, 4501, 4352, 4502 (fra, since, von, depuis 2007), 4405E, Sirio SRQ 400	62 465 40
	RAV 630, 635, 640, 650, 660 m. lys, with lights, mit Licht, avec éclairage (fra, since, von, depuis 2008)	62 476 00
	RAV 630, 635, 640, 650, 660, 630SI, 635SI, 640SI, 650SI, 660SI uden lys	62 470 00
	without lights, ohne Licht, sans éclairage (fra, since, von, depuis 2008)	
	RAV 4506 OF	62 470 25
Rotary	SM123, SM40, SM41, SM43, SM44	62 280 00
	SM65-51/55	62 402 00
Sherpa	Safelift 4-2	62 277 00
Sice	PQC40WCT	62 465 40
	PQC 40 CT	62 476 00
Slift	Classic CS 40	62 270 00
	Maestro M-A32.386	62 355 00
Snap-on (Sun)	EELR 113A/114A **)	62 270 00
Space	SQ406	62 470 25
	SQ503	62 465 40
	SF6502	62 470 00
	SQ350, SQ351, SQ401, SQ405E, SQ400, SQ501E, SQ402, SQ406E, SQ502E	62 265 20
Stenhøj	Major, Mono (til, until, bis, jusqu' 1997) (m. opbukket kant, with bent up edges, mit hochgebogener Kante, avec bord plié)	62 262 00
	Biglift	62 264 00
	Major 400, 500, 4030, 5230, Mono (fra, since, von, depuis 1997)	62 264 10
	(med påskruet alukant (16mm), with alu edge (16 mm), mit Aluminiumschiene (16 mm), avec bord en alu (16 mm))	
	Ny konstruktion fra 2004, new construction since 2004, neuer Konstruktion seit 2004, nouvelle construction à partir de 2004)	
	(In Great Britain mounted without alu edges)	62 265 10
	Major 3351 S (2009), 4030 (fra, since, von, depuis 11/2009), 5230, 7230	62 471 50
	Major 3351 / 4026 - 42 / 4030 - 5230, 5230-55 S og 6230 -55 S . :Lifte fra 2012 u. kant KUN anvendelig på lifte uden lys eller med LED lys monteret. For lifts from 2012 without edge. Only for lifts without light or w/LED Für Bühnen von 2012 ohne Kante. Nur für Bühnen ohne Licht oder mit LED. Pour ponts à partir de 2012 sans rail. Seulement pour ponts sans éclairage ou avec LED.	62 478 00
	Monarch 35 (fra, since, seit, depuis 2002)	62 353 00
	- nogle få førsteudgaver, for few first editions, für einige Erstaubgaben, quelques un des premiers modèles)	
	Monarch 35 (ændret fra 2004, changed since 2004, seit 2004 geändert, changé à partir de 2004 **) 5mm kant, edge, Kante, bord	62 280 00
Monarch 35 (ændret fra 2004, changed since 2004, seit 2004 geändert, changé à partir de 2004 **) 10mm kant, edge, Kante, bord	62 270 00	
Steril Koni	KO/KS 4040, KO/KS 4045, KO/KS 2028D, KO/KS 4028, KO/KS 4025, 4035	62 262 10
	ST 0035D, ST 4032, 4040, 4055, 4070 F/V/LV (evt. 62.270.00)	62 353 00
	4032F	62 353 00
	ST4040WA	62 354 60
Tecalemit	SF8788 (4 ton)	62 273 00
	SF9650, SF 9657	62 265 00
TEXO	Xenia 3 ton, 4 ton, 5 ton (ændringer 2004, changes 2004, Änderungen 2004, modifié 2004)	62 290 00
	Fulgor PSWT 4 (ændringer 2004, changes 2004, Änderungen 2004, modifié 2004)	62 280 00
Tip Top	Prolift 4.40 AS/A	62 284 00
Union	8702, 8704, 8705	62 262 00
Velyen	4 ED 1000R	62 355 00

Werther (EWJ)	W437,W439,W440	62 359 00
	W443,W442LP,WATLT443	62 276 00
	W430,W435,W436,W441,W442,W450	62 263 00
	W450 m. lys, with lights, mit Licht, avec éclairage	62 270 00
	W460,W450LT,W450ATLT (+62.258.00 ; hvis variabel, when adjustable, fals variabel, si réglable)	62 265 00
Zippo	2305, 2306, 2405, 33 I I	62 283 00
	2420	62 275 00
	9340Z	62 270 00
	8090, 809 I, 819 I, 8450 st	62 289 00
	4149.I***, 4149.I AV***, 4149.I RF***, 4149.I RFAV***, 4149.I ASD***, 4149.I RFASD***	62 290 00
	4144, 4149 - Justerbar kørebaner, adjustable platforms, Verschiebahre fahrschienen, rails de roulement réglable	62 283 00
	8135, 8140	62 280 00

**DK**

Denne liste er baseret på enkelte eksemplarer af de pågældende lifte. AC tager forbehold for eventuelle ændringer i liftproducenternes produkter. Erfaringer med kombineret af lifte og ophæng modtages gerne.

- \*) Kontroller afstand mellem ophængsskinner (min. 817 mm)
- \*\*) Kontroller afstand mellem ophængsskinner (min. 830 mm)  
Hvis afstanden mellem ophængsskinnerne er mindre end 830 mm og mere end 785 mm, anbefales ophæng 62.290.00.
- \*\*\*) Kun brugbar uden lys.
- \*\*\*\*) På grund af hyppige ændringer på serien af Nussbaum lifte kan vi ikke garantere, at de angivne ophæng passer. Derfor venligst kontakt os eller medsend målskema til lift ved bestilling!

**62 262 00**

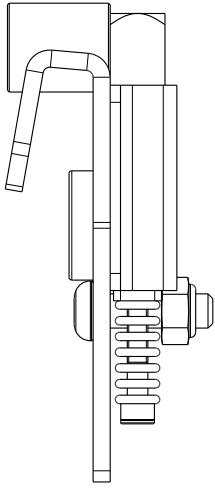

**62 262 10**

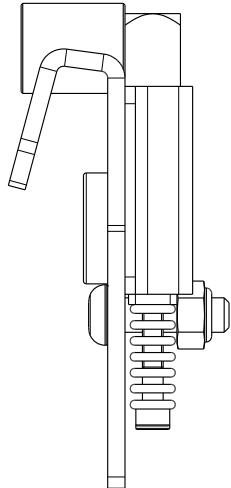

**62 263 00**

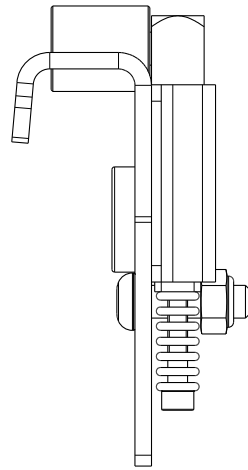

**62 263 20**

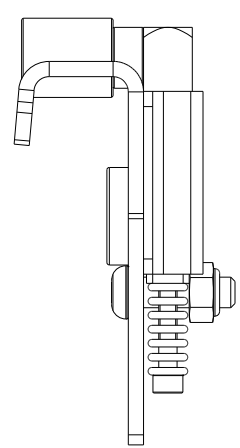

**62 264 00**

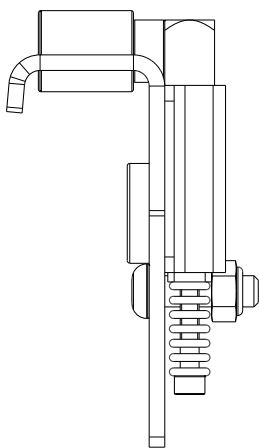

**62 264 10**

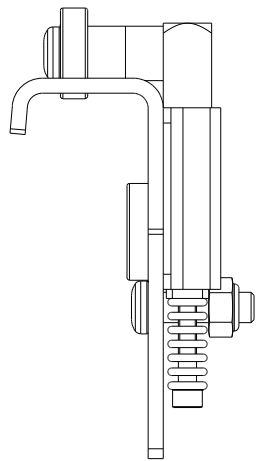

**62 265 00**

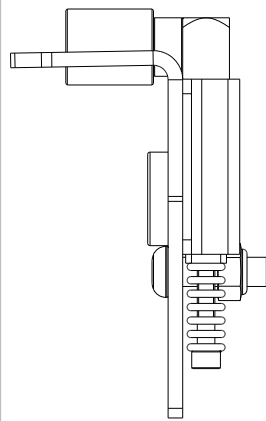

**62 265 10**

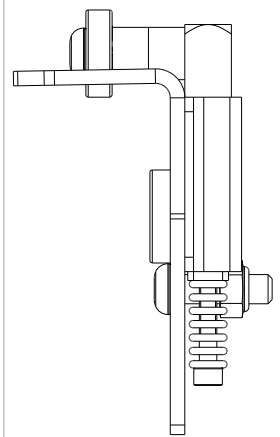

**62 265 20**

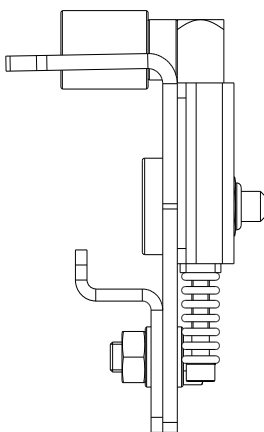

**62 267 00**

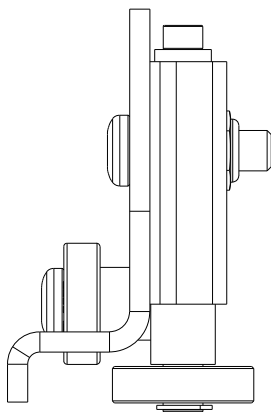

**62 268 00**

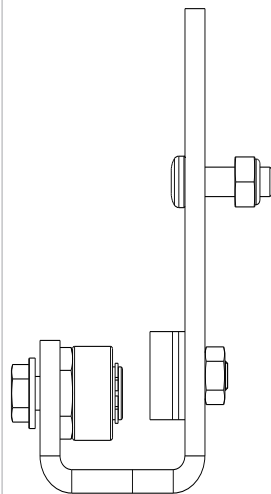

**62 269 00**

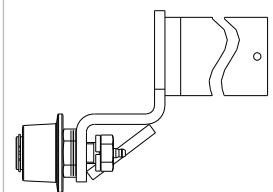

**62 270 00**

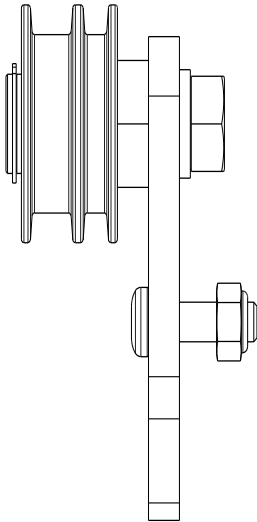

**62 272 00**

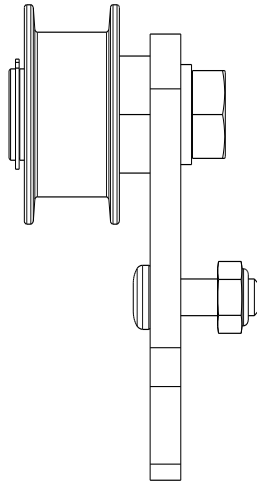

**62 273 00**

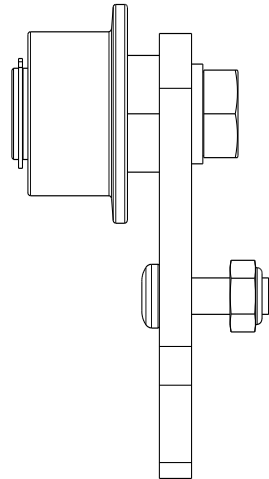

**62 274 00**

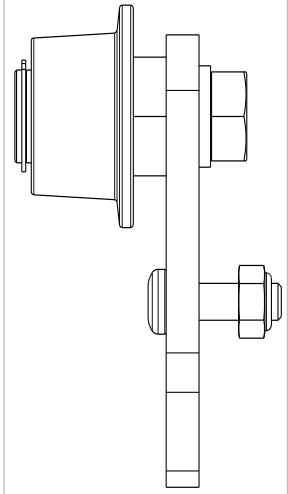

**62 275 00**

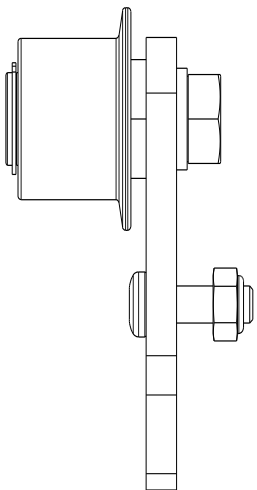

**62 276 00**

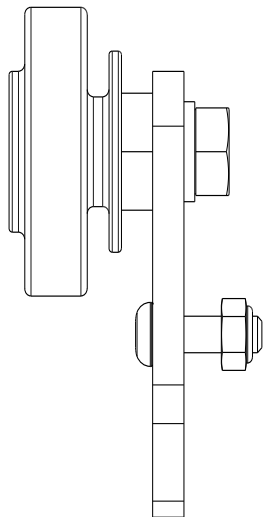

**62 277 00**

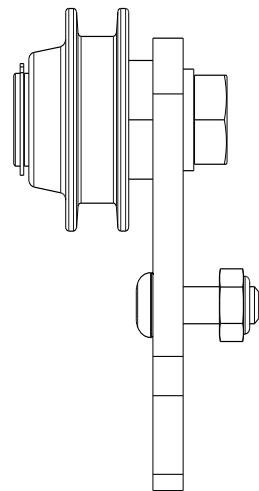

**62 280 00**

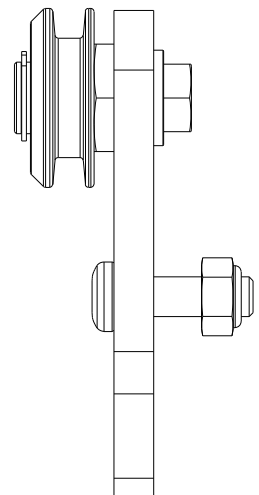

**62 281 00**

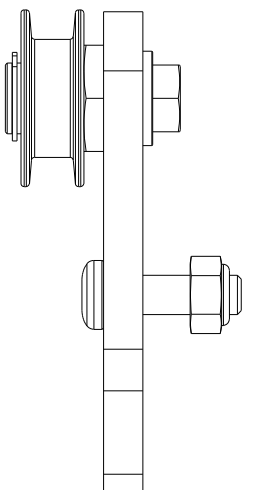

**62 282 00**

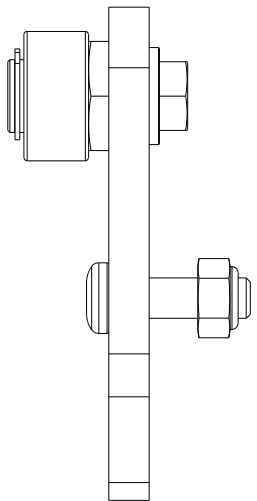

**62 283 00**

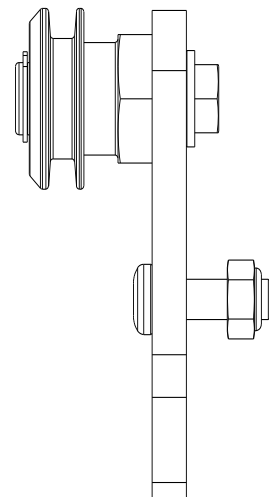

**62 284 00**

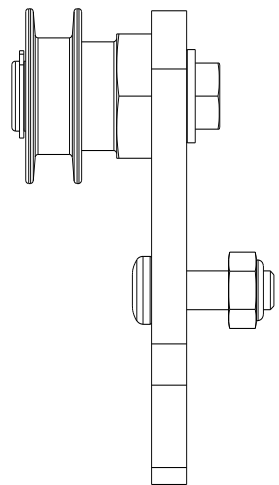

**62 285 00**

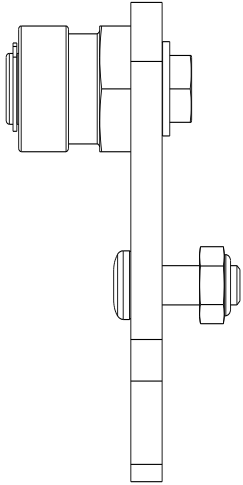

**62 286 00**

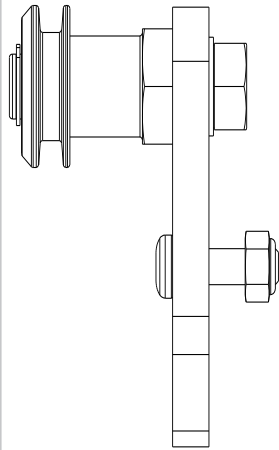

**62 287 00**

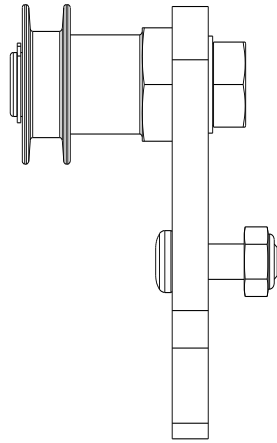

**62 288 00**

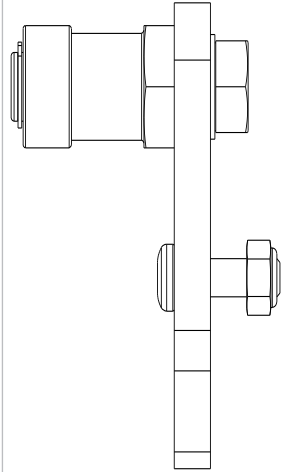

**62 289 00**

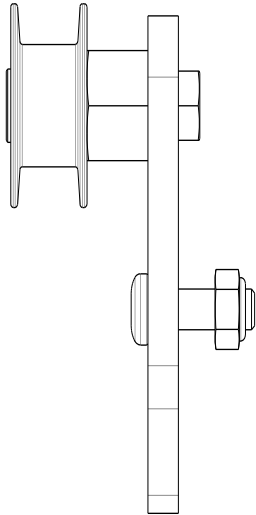

**62 289 10**

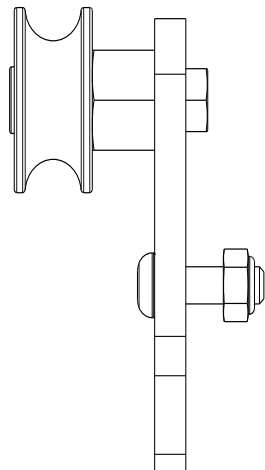

**62 290 00**

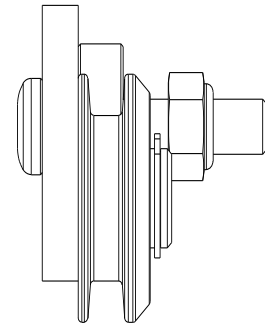

**62 292 00**

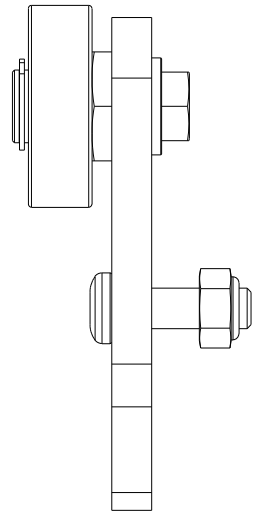

**62 293 00**

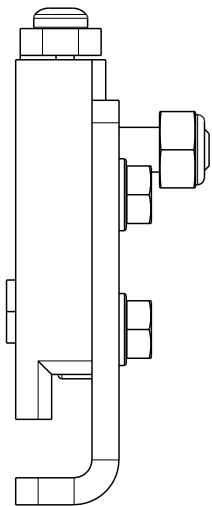

**62 295 00**

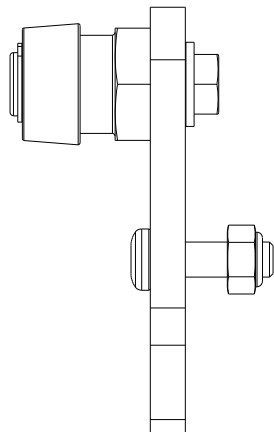

**62 298 00**

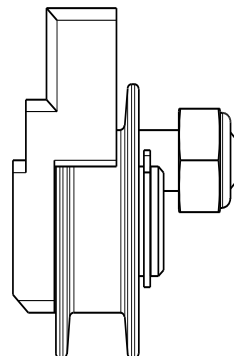



**62 341 00**

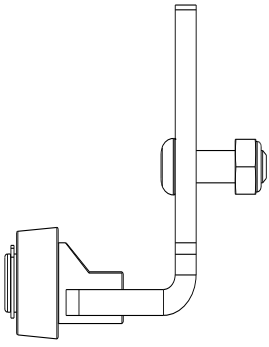

**62 342 00**

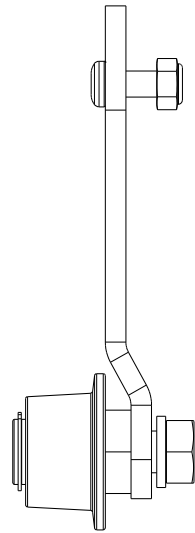

**62 343 00**

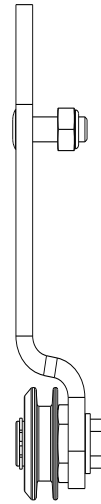

**62 344 00**

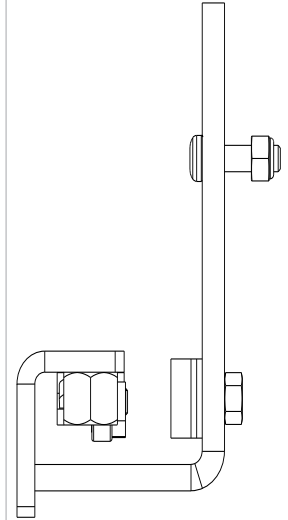

**62 346 00**

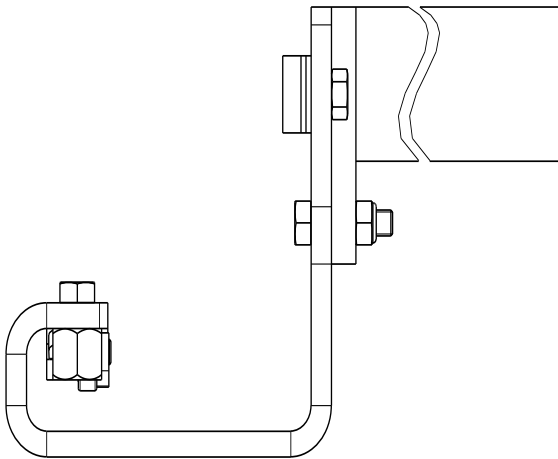

**62 346 50**

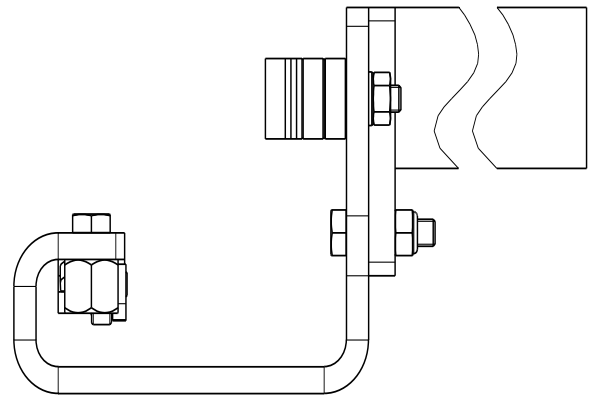

**62 352 00**

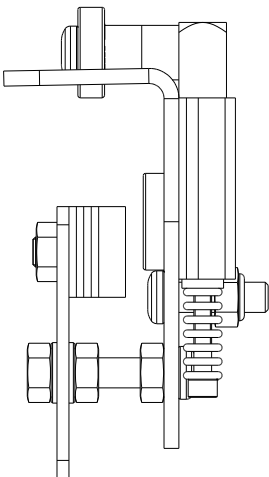

**62 353 00**

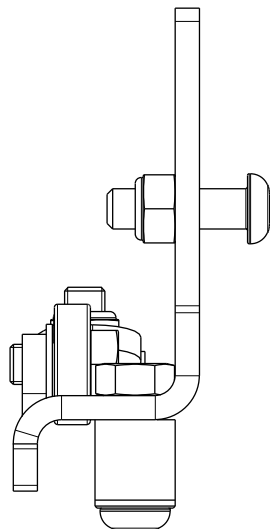

**62 354 00**

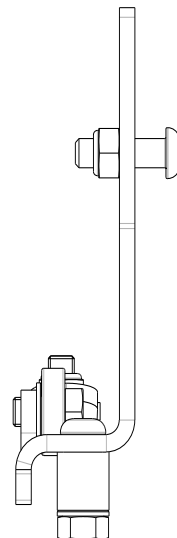

**62 354 60**

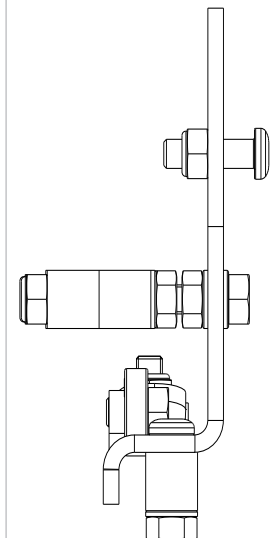

**62 355 00**

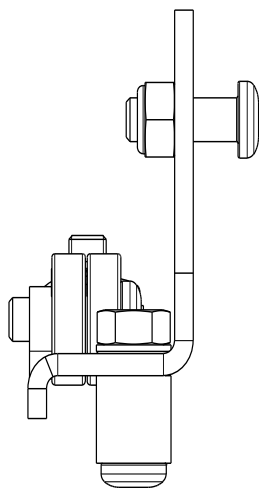

**62 356 00**

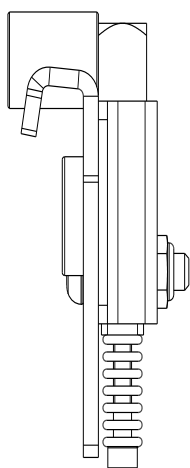

**62 356 10**

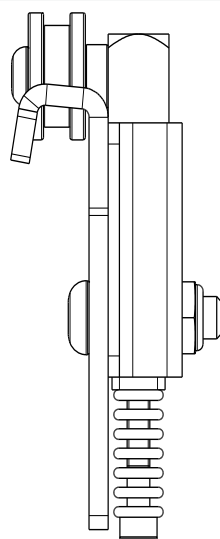

**62 357 00**

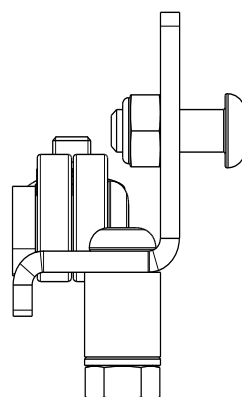

**62 358 00**

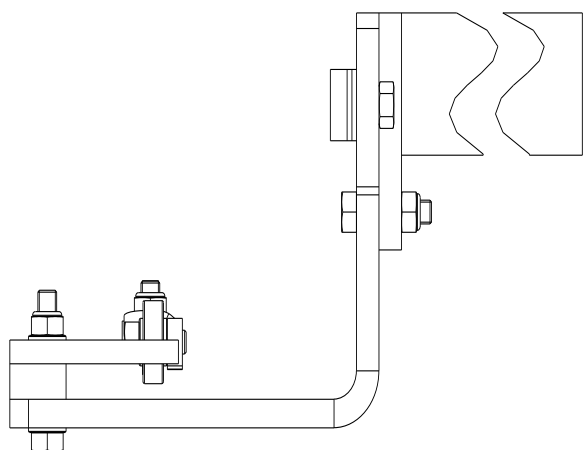

**62 359 00**

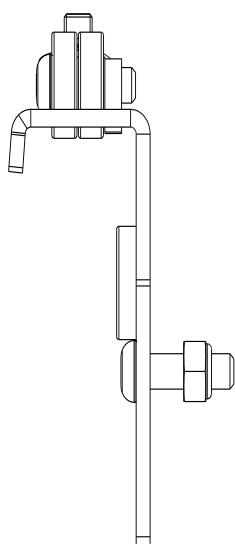

**62 359 20**

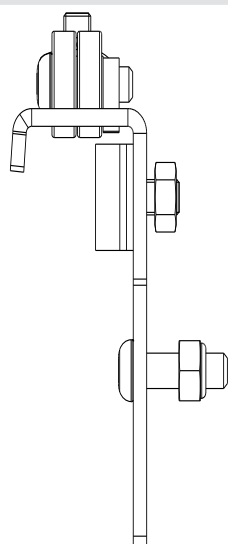

**62 402 00**

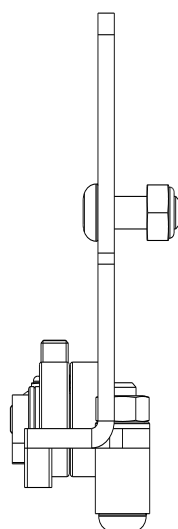

**62 465 40**

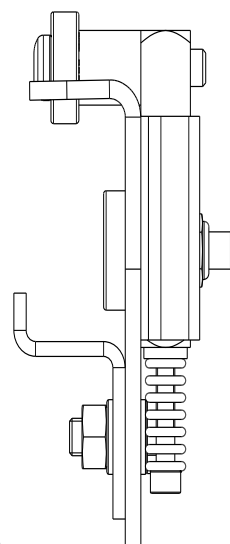

**62 470 00**

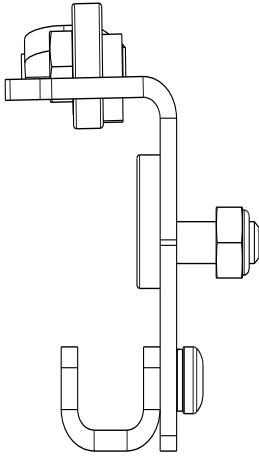

**62 470 25**

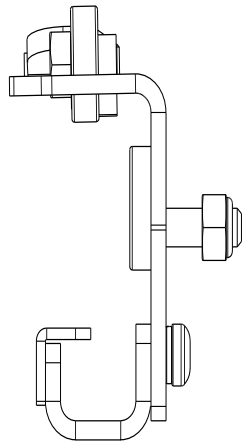

**62 471 50**

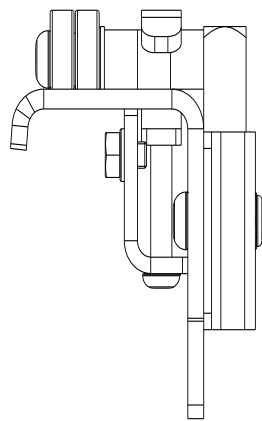

**62 472 00**

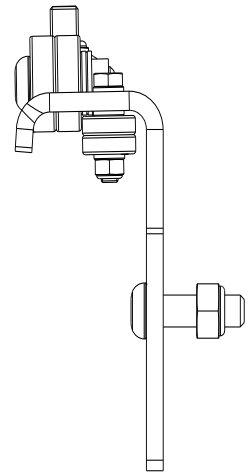

**62 475 00**

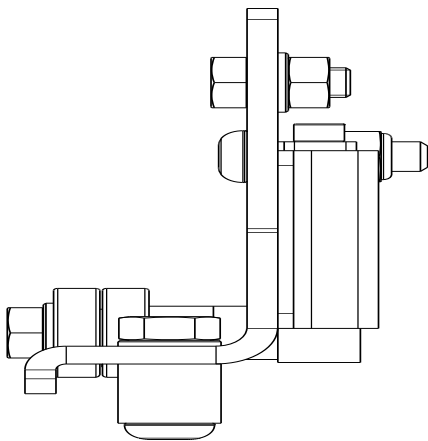

**62 476 00**

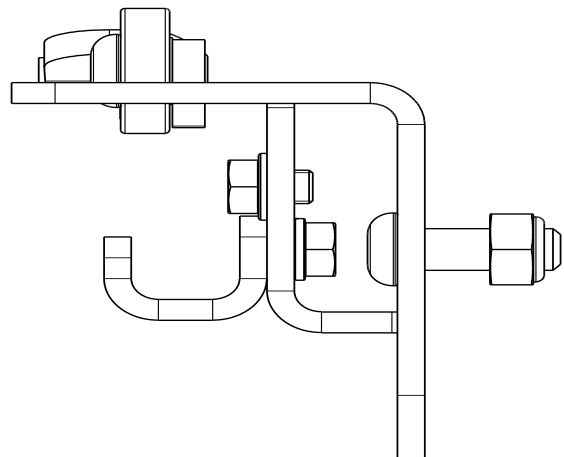

**62 478 00**

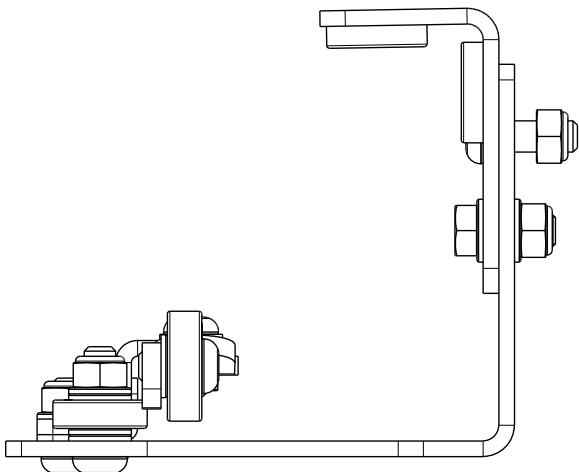

**62 481 00**

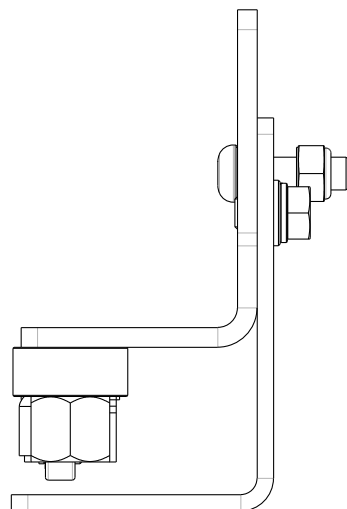

Varenr. Article no. Artikel Nr. Référence	A	B	C	D	E	L		H		W	
						min.	max.	min.	max.	min.	max.
						62 262 00	-	12	-	ø25	-
62 262 10	-	12	-	ø25	-	125	187,5	-2,5	65	805	1205
62 263 00	-	28	-	ø25	-	125	187,5	-2,5	65	805	1205
62 263 20	-	28	-	ø25	-	125	187,5	-2,5	65	805	1205
62 264 00	-	38	-	ø25	-	125	187,5	-2,5	65	805	1205
62 264 10	-	38	-	ø30	-	125	187,5	-2,5	65	805	1205
62 265 00	-	-	(50)	ø25	-	125	187,5	-2,5	65	805	1205
62 265 10	-	-	(50)	ø30	-	125	187,5	-2,5	65	805	1205
62 265 20	-	-	(50)	ø25	-	131	143	44	56	805	1205
62 267 00	-	(20)	-	ø30	-	25	37,5	152,5	165	800	1200
62 268 00	(29)	(16)	(25)	ø32	32	-28	34	152	214	886	1286
62 269 00	(79-75)	26	33,5	ø45	ø52,5	-17,5	22,5	167,5	207,5	946	1346
62 270 00	14,5	7/12,5	33,5	ø45	52,5	-2,5	150	40	192,5	830	1230
62 272 00	14,5	24	33,5	ø45	52,5	-2,5	150	40	192,5	830	1230
62 273 00	14,5	26	31,6	ø45	52,5	-2,5	150	40	192,5	830	1230
62 274 00	14,5	26	31,8	ø45	52,5	-2,5	150	40	192,5	830	1230
62 275 00	5	33	38,3	ø43,5	52,5	-2,5	150	40	192,5	820	1220
62 276 00	14	-	32	ø79	-	24,5	127,5	58,5	210,5	828	1228
62 277 00	12	12,5	34	ø45	52,5	36	73	114	151	824	1224
62 280 00	8	7	17	ø30	37,5	5	157,5	32,5	185	817	1217
62 281 00	8	10,5	17	ø30	37,5	5	157,5	32,5	185	817	1217
62 282 00	(6)	(16)	(20)	ø30	30	5	157,5	32,5	185	812	1212
62 283 00	23	7	17	ø30	37,5	5	157,5	32,5	185	847	1247
62 284 00	23	10,5	17	ø30	37,5	5	157,5	32,5	185	847	1247
62 285 00	(20)	(16)	(20)	ø30	30	5	157,5	32,5	185	840	1240
62 286 00	37	7	17	ø30	37,5	5	157,5	32,5	185	875	1275
62 287 00	37	10,5	17	ø30	37,5	5	157,5	32,5	185	875	1275
62 288 00	(34)	(16)	(20)	ø30	30	5	157,5	32,5	185	870	1270
62 289 00	23	19	23,5	ø30	40	-1,5	150,5	34	186	846	1246
62 289 10	23,5	18	23	ø32	41	-1	151	35	187	847	1247
62 290 00	(-11)	7	(17)	ø30	37,5	60	72,5	117,5	130	780	1130
62 292 00	(5)	(16)	(20)	ø50	50	-5	147,5	42,5	195	812	1212
62 293 00	0	9	17	(ø30)	80,5	28,5	65,5	114	151	786	1186
62 295 00	(20)	(16)	(20)	ø32	32	2	156	31	186	840	1240
62 298 00	-	10,5	22	ø30	37,5	60	72	114	126	780	1176
62 341 00	(45)	(16)	(21)	ø35	35	-7	30,5	159,5	197	886	1286
62 342 00	5,5	26	33,5	ø45	52,5	-73,5	-41	231	263,5	808	1208
62 343 00	(-16,5)	7	18,5	ø30	37,5	-75,5	-43	233	265,5	764	1164
62 344 00	45	9	38	ø30	-	-22	-40	165	227	890	1290
62 346 00	110,5	9	-	ø30	37	-25	25	161	211	1078	1378
62 346 50	110,5	9	-	ø30	37	-8	154	17	179	1069	1369
62 352 00	-	-	(50)	ø30	-	125	187,5	-2,5	65	805	1205
62 353 00	(30-20)	4-14	20-10	ø30	33	8	70,5	116	178,5	830	1230
62 354 00	(30-20)	4-14	20-10	ø30	33	-42	19	166	228	833	1233
62 354 60	(30-20)	4-14	20-10	ø30	33	-42	19	166	228	833	1233
62 355 00	(31-21)	3-13	19-9	ø30	32	28	75,5	111	158,5	830	1230
62 356 00	-	12	-	ø25	-	105	167	17,5	85	805	1205

62 356 10	-	7	-	∅24	-	111	173	14	76	805	1205
62 357 00	36-26	4-14	20-10	∅30	32	52	64	122	135	830	1230
62 358 00	-	-	-	∅35	-	16,5	33,5	163	213	1050	1350
62 359 00	-	38	-	∅30	-	129	191	-5	57	802	1202
62 402 00	1-13,5	3,5-16	31,3-18,8	∅35	35	-11	51	51	136	794	1194
62 359 20	-	38	-	∅30	-	129	191	-5	57	810	1210
62 465 40	-	-	(24)	∅30	-	126	138	48	60	805	1205
62 470 00	-	-	(40)	∅30	-	120	157	29	66	805	1205
62 470 25	-	-	(40)	∅30	-	120	157	29	66	805	1205
62 471 50	31,5	26	36	∅30	-	120	157	30	67	855	1255
62 472 00	23-37	3,5-17,5	10-24		33	122,5	184,5	1,5	63,5	838	1238-1266
62 475 00	25-33	4-12	13,5-21,5	∅30	24	15	47	134	196	842	1242
62 476 00	-	-	(40)	∅30	24	15	47	134	196	842	1242
62 478 00	-		(45)		(12)	114	151	36	73	814	1204
62 481 00	33,5		(35)	∅30	(41)	-27	35	152	214	859	1259

**Ophæng for saksedonkrafte**  
**Support arms for jacking beams**  
**Aufhängungen für Scherenheber**  
**Jeux d'accroches pour traverses de levage**

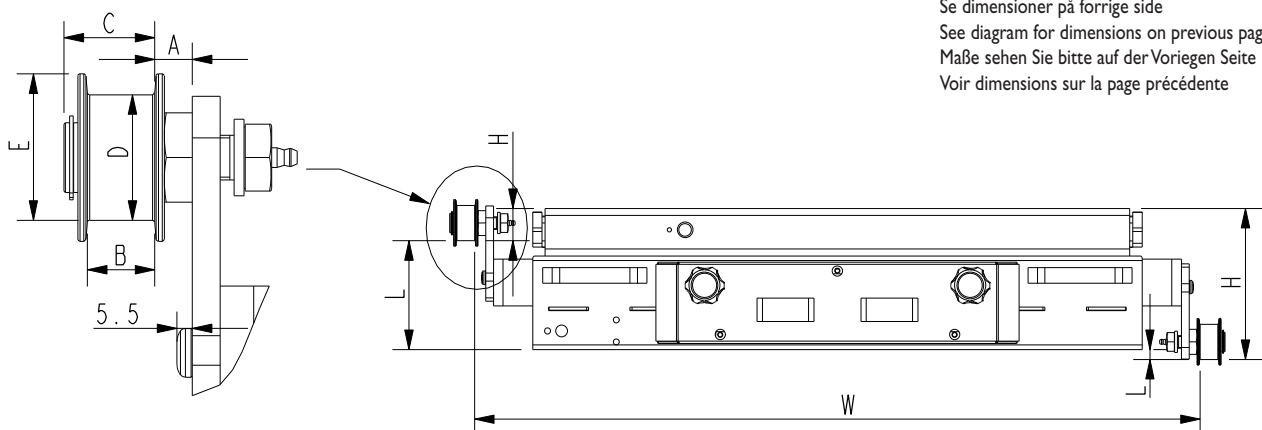

## SD20/26L & SD20/26PHL

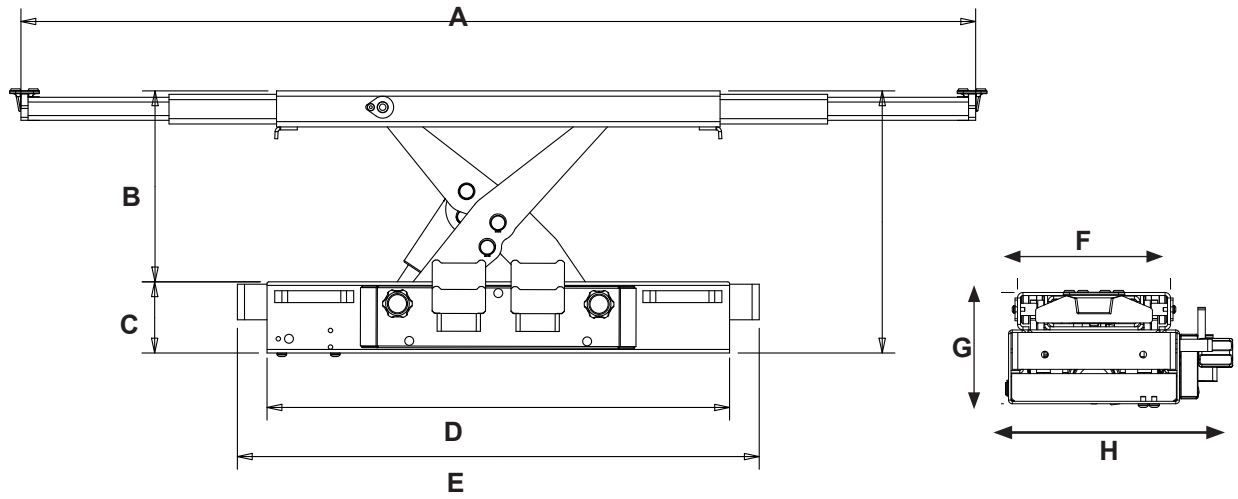

Model	A	B	C	D	E	F	G	H
SD20L	780-1610	250	120	780	780-1180	249	180	365
SD26L	780-1610	250	120	780	780-1180	249	180	365
SD20PHL	780-1610	250	120	780	780-1180	249	180	365
SD26PHL	780-1610	250	120	780	780-1180	249	180	365

A	Teleskopudtræk/Løftearme mm Telescopic arms mm. Teleskopauszug/Hubarme mm Bras télescopique mm	C	Rammehøjde mm Frameheight mm Chassishöhe mm Hauteur de cadre mm	E	Bredde incl. udtræk mm Frame width mm Auszug Aufhängung mm Longeur de bras rallonge mm	G	Min. højde mm Min. height mm Min. Höhe mm Hauteur mini mm
B	Slaglængde mm Stroke mm Kolbenhub mm Course mm	D	Rammebredde mm Framewidth mm Rahmenbreite mm Longeur de cadre mm	F	Løfteramme bredde mm Lifting frame width mm Hubrahmen Breite mm Largeur de cadre de levage mm	H	Total bredde mm Total width mm Gesamtbreite mm Largeur totale mm