

Glow plug removal kit

Complete kit for glow plugs tip extraction M8x1 - M9x1 - M10x1 and M10x1.25, **20 pz**



DOUBLE EXTRACTION SYSTEM

SAFE REMOVAL, NO DAMAGE TO THE CYLINDER HEAD

BREAKING ZONE

NEW EXTRACTION SYSTEM WITH THREADED EXTRACTOR

Complete Kit

311 204 000

- ▶ Set of tools for the extraction of part of the electrode terminal part of the glow plugs (M8, M9, M10) in the event of breakage or seizure inside the seat, otherwise impossible to remove.
- ▶ The set includes all the tools needed to safely remove the terminal part of the glow plug electrode without damaging the cylinder head. This operation becomes very simple and fast.

The alternative is to disassemble the head, the time saving therefore becomes considerable.

- ▶ It allows to operate in two different ways:

- 1 EXTRACTION WITH SLIDE HAMMER**
- 2 EXTRACTION WITH THREADED EXTRACTOR**

1 EXEMPLE FOR EXTRACTION WITH SLIDE HAMMER

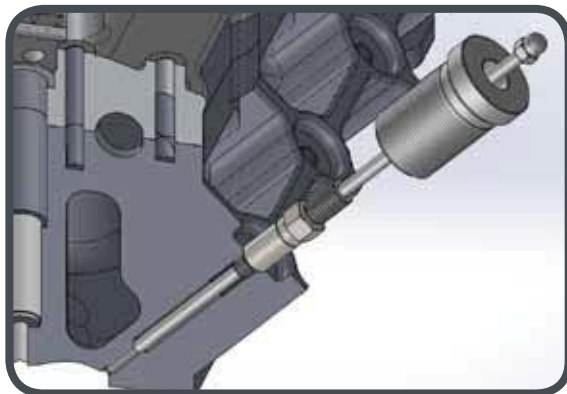

2 EXEMPLE FOR EXTRACTION WITH THREADED EXTRACTOR

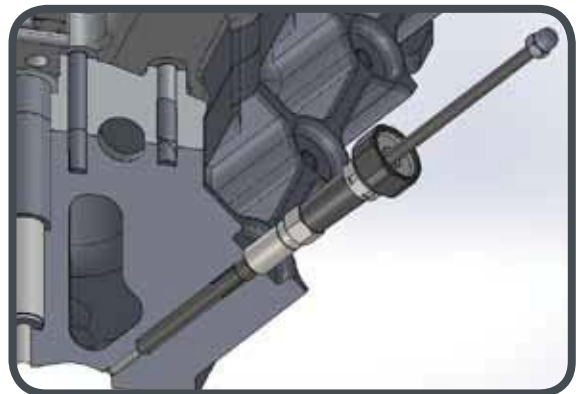

SAVING TIME



SAVING MONEY



SATISFIED CUSTOMER

Glow plug removal kit

BELOW THE MAIN APPLICATIONS, ON EACH TYPE OF GLOW PLUG

M8x1

FIAT	LANCIA	FORD
IVECO	ALFAROMEIO	PEUGEOT
JAGUAR	LANDROVER	CITROËN
JEEP	VOLVO	CHRYSLER

M8x1 SPECIAL APPLICATION

The kit contains the tools to remove the glow plugs tip that are mounted in M8x1 glow plug. The electrode tip has the same measure of the one of the standard M10 glow plug.

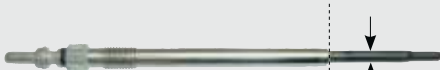

BREAKING ZONE AND DIMENSIONS

Minimum outside diameter of electrode tip = $\varnothing 4,3$
Maximum diameter of internal hole = $\varnothing 3$

CITROËN	XSARA	1.4 HDI
	XSARA BREAK	1.4 HDI
	XSARA COUPE	1.4 HDI
	XSARA PICASSO	1.6 HDI
	BERLINGO	1.6 HDI 90
	C2	1.4 HDI
		1.6 HDI
	C3 (FC_)	1.4 HDI
		1.4 HDI 16V
	C3 PLURIEL	1.4 HDI 16V
		1.4 HDI
	C4 COUPE	1.6 HDI 110 FAP
	C4 GRAND PICASSO	1.6 HDI 110 FAP
	C5	1.6 HDI
	C5 BREAK (RE)	1.6 HDI
FIAT	FIESTA V	1.4 TDCI
	FOCUS C-MAX	1.6 TDCI
	FOCUS II	1.6 TDCI
	FUSION	1.4 TDCI
		1.6 TDCI
MAZDA	2	1.4 CD
PEUGEOT	107	1.4 HDI
	206 (2A/C)	1.4 HDI ECO 70
	206 SW (2E/K)	1.4 HDI
		1.6 HDI FAP 110
	206 CC (2D)	1.6 HDI FAP 110
	207	1.4 HDI
		1.6 HDI
	307 (3A/C)	1.4 HDI
		1.6 HDI
	307 BREAK (3E)	1.6 HDI FAP 110
		1.6 HDI
	307 SW (3H)	1.6 HDI FAP 110
		1.6 HDI FAP 110
407	1.6 HDI FAP 110	
407 SW	1.6 HDI FAP 110	
1007	1.4 HDI	
SUZUKI	LIANA / KOMBI	1.4 DDIS
TOYOTA	AYGO	1.4 HDI
VOLVO	S 40 II	1.6 D
	V 50	1.6 D

BELOW THE MAIN APPLICATIONS, ON EACH TYPE OF GLOW PLUG

M9x1	ALFA ROMEO	JEEP	SAAB
	FIAT	LANCIA	OPEL
M10x1	BMW	VW	PORSCHE
	MINI	SEAT	VOLVO
	MERCEDES	SKODA	OPEL
	RENAULT	FIAT	SAAB
	NISSAN	CHRYSLER	JEEP
	AUDI		
M10x1.25	CHEVROLET	NISSAN	HONDA
	MITSUBISHI	RENAULT	SAAB
	ISUZU	OPEL	LEXUS
	SSANGYONG	KIA	HYUNDAI
	MAZDA	TOYOTA	

Components

311205004

M4 extraction rod fitted with nut

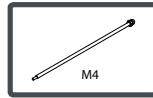

311205014

M4 male fitted with extension

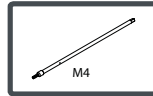

311205006

M4 extraction rod fitted with nut (special application)

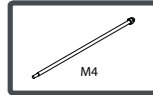

311205016

M4 male fitted with extension (special application)

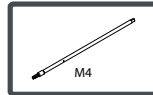

311204011

M4 - M6 extraction rod fitted with nut

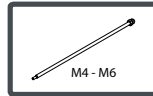

311205002

M3 extraction rod fitted with nut

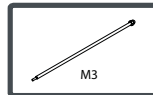

311204009

M3 - M5 extraction rod fitted with nut

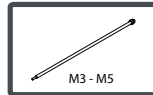

311204013

M4 - M5 extraction rod fitted with nut (special application)

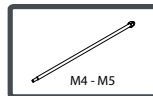

311205012

M3 male fitted with extension

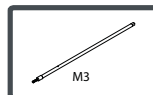

311205019

Ø2,5 tip fitted with extension

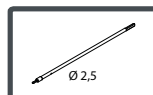

Components

311205023

Ø3,2 tip fitted with extension

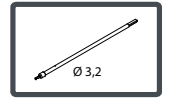

311205021

Ø3,2 tip fitted with extension (special application)

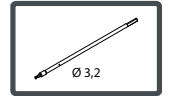

311205017

M10 Glow plug extraction slide hammer

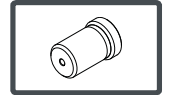

311204007

M5 extraction nut

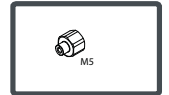

311204008

M6 extraction nut

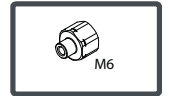

311204005

Body + bearing + ring

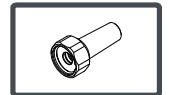

311204001

M8x1 glow plug guide

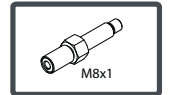

311204002

M9x1 glow plug guide

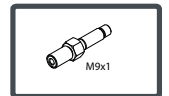

311204003

M10x1 glow plug guide



311204004

M10x1.25 glow plug guide

