

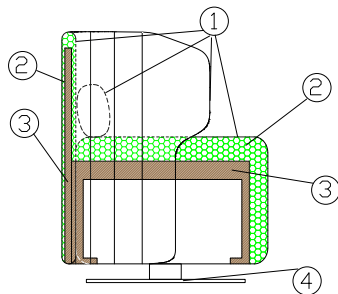

MAJI COLLECTION



The name - Maji - comes from Japanese, and means “Really?”, an exclamation of surprise and amazement, as if it stirred questions such as “Can you actually sit in that shell? Can you really combine so many elements together?” Maji is an original modular system for office spaces or waiting areas, versatile and adaptable to any setting. It consists of a padded wall, which can be endlessly modulated, and it can wrap, as a protective shell, the most diverse elements, such as chairs, sofas, shelves, hangers.



MAJI LOW

- 1 - dacron® fiber 100 gr;
- 2 - high resilience polyurethane foam of different densities;
- 3 - structural frame in solid firwood;
- 4 - swivel frame in polished inox and column in plated chrome metal.

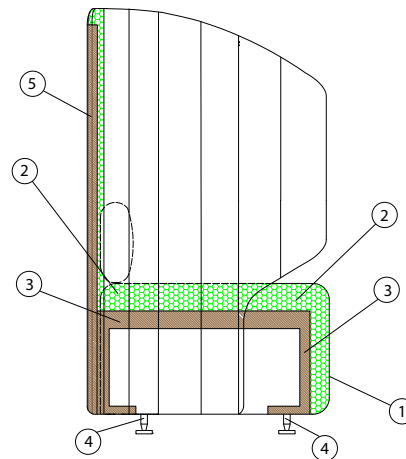

MAJI HIGH

- 1 - dacron® fiber 100 gr;
- 2 - high resilience polyurethane foam of different densities;
- 3 - structural frame in solid firwood;
- 4 - swivel frame in polished inox and column chrome metal /plated chrome metal feet.
- 5 - structural frame in curved plywood.

DIMENSIONS

Low

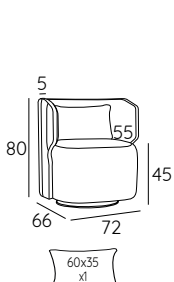

High

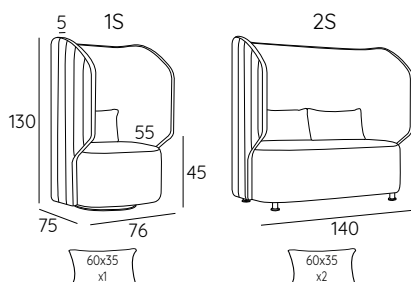



MAJI COLLECTION

BASE AND FEET

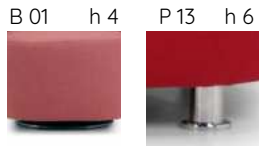

BACKREST FINISHINGS



TECNICAL DETAILS

			fabric mtl H 140 cm	leather m ²
MAJI LOW 1S	30	0.40	4.70	8.74
MAJI HIGH 1S	35	0.77	6.50	12.09
MAJI HIGH 2S	48	1.40	9.00	16.74

1S low

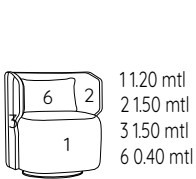

1S High

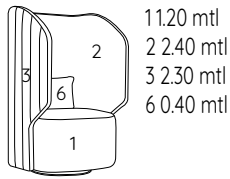

2S High

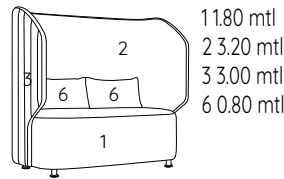

SUGGESTED FABRICS

Fabrics



Leathers



PHOTO GALLERY



Maji low armchair

Maji high armchair

Maji high sofa