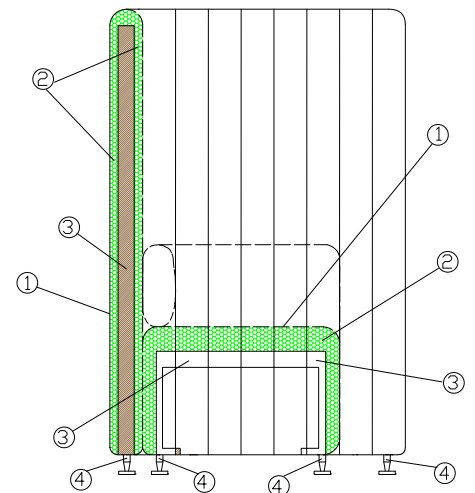


MAJI SYSTEMS



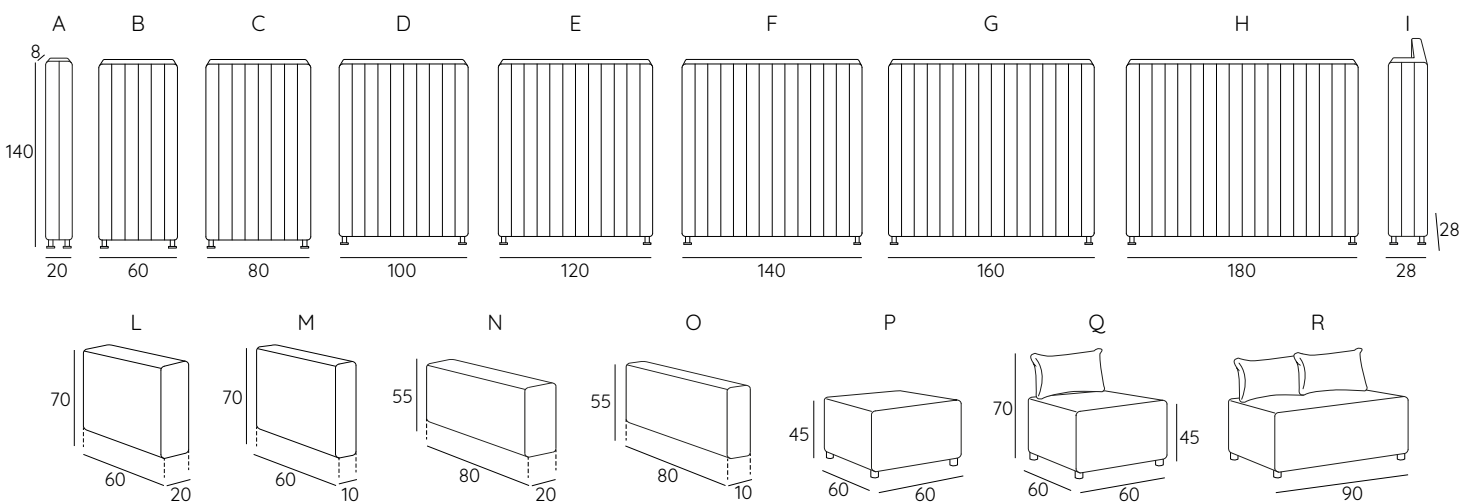
The name - Maji - comes from Japanese, and means "Really?", an exclamation of surprise and amazement, as if it stirred questions such as "Can you actually sit in that shell? Can you really combine so many elements together?" Maji is an original modular system for office spaces or waiting areas, versatile and adaptable to any setting. It consists of a padded wall, which can be endlessly modulated, and it can wrap, as a protective shell, the most diverse elements, such as chairs, sofas, shelves, hangers.

- 1 - dacron® fiber 100 gr;
- 2 - high resilience polyurethane foam of different densities;
- 3 - structural frame in solid firwood;
- 4 - plated chrome metal feet.

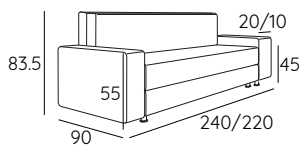
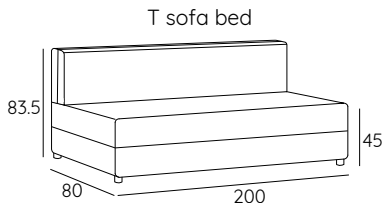
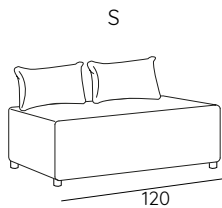


DIMENSIONS

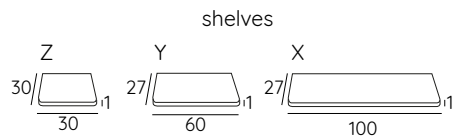
Modules



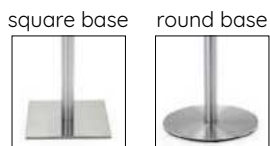
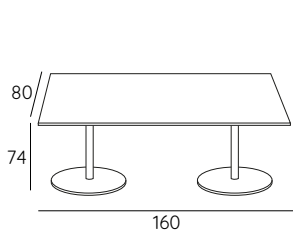
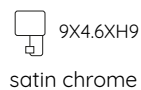
MAJI SYSTEMS



Opening-closing system
item S whit bed

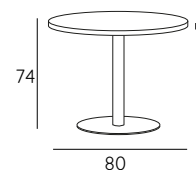
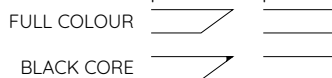


coat hook



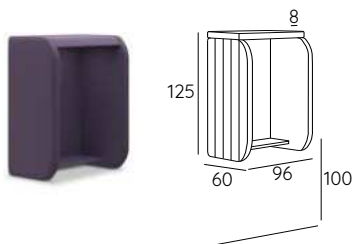
tables

profile WH profile ZA

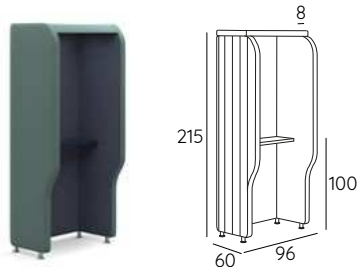


phone booths

PHONE BOOTH WALL



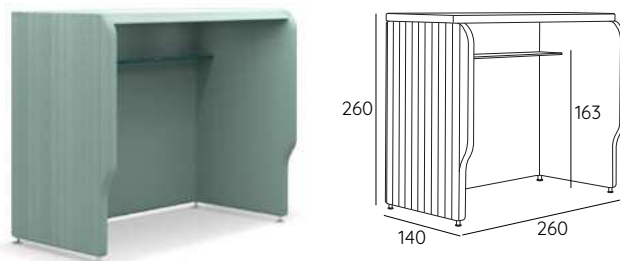
PHONE BOOTH FREESTANDING



SINGLE PHONE BOOTH

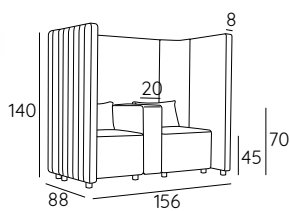


printers cabinet

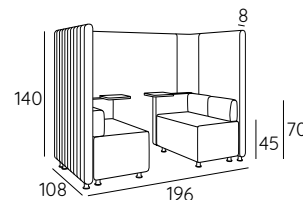


systems

SYSTEM 1



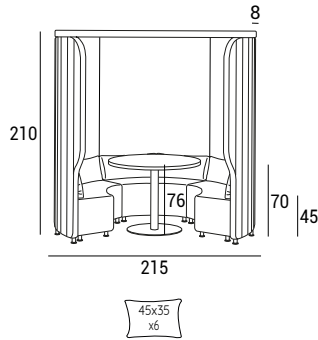
SYSTEM 2



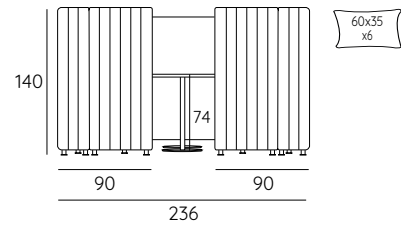
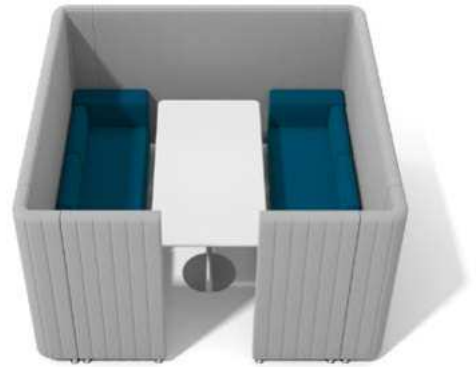
MAJI SYSTEMS



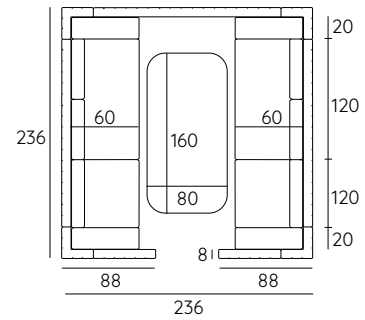
ROUND PHONE
BOOTH D 215



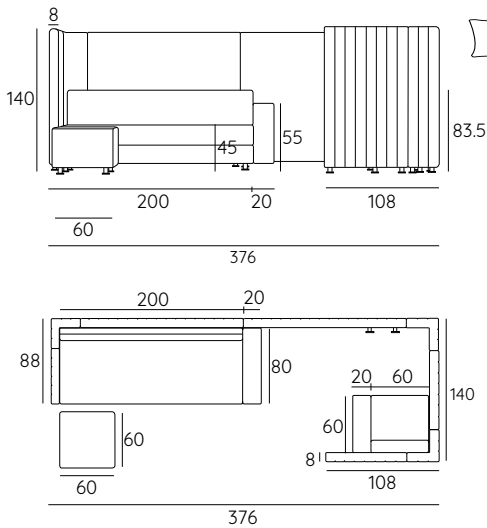
SYSTEM 6



SYSTEM 7



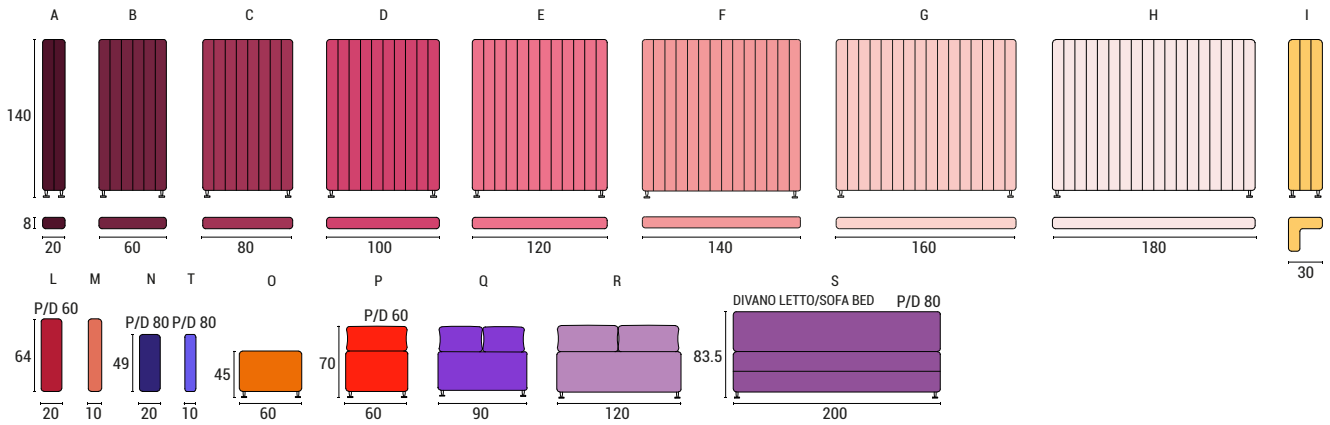
Opening-closing system
item S whit bed



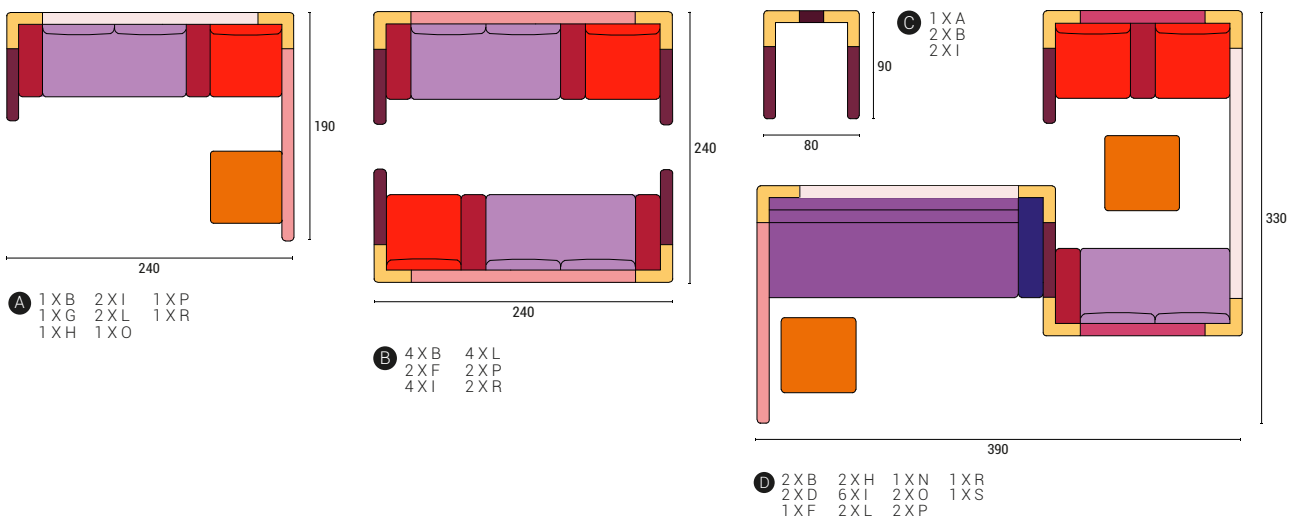
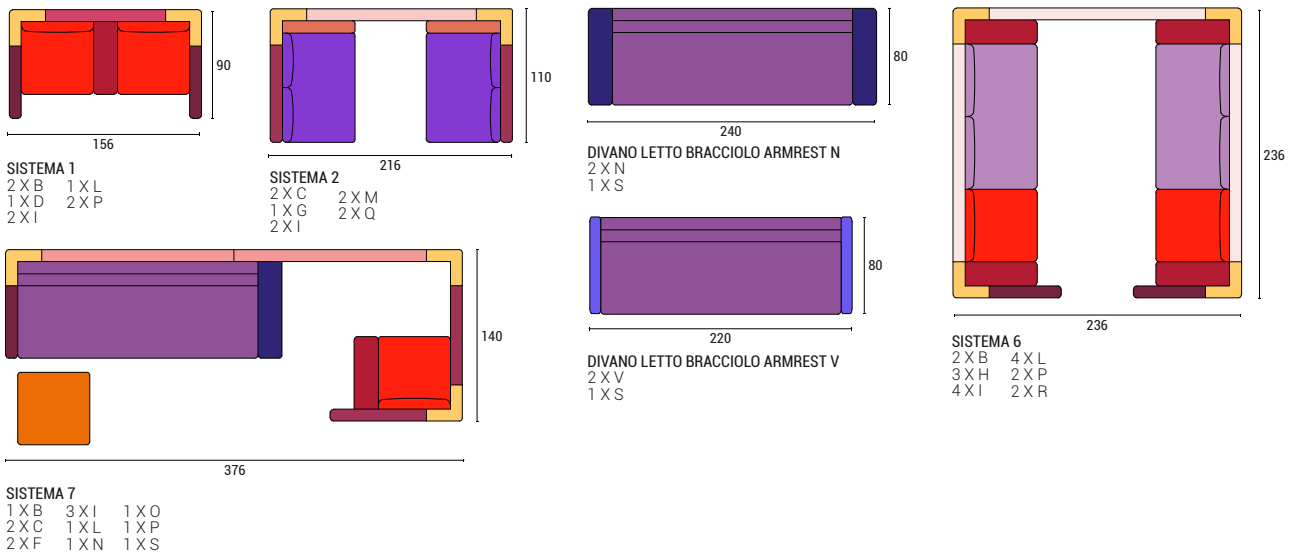
MAJI SYSTEMS



SUGGESTED CONFIGURATIONS



Systems



MAJI SYSTEMS



FEET

P 13 h 6



BACKREST FINISHINGS

quilted



plain



PLUGS

PIX-SCHUKO



1 x **Schuko**
Power supply 230 V.
UK and USA plug on demand.



PIX-USB



2 x **USBA**
Power supply 230 V.
Different voltage upon request.



PICK



PICK-2A= 2 x USBA
PICK-AC= 1 x USBA + 1 x USBC
Power supply 110-240 V AC.
Colors: in matt black, matt white and stainless steel.



HIT

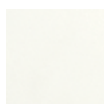


1 x **Schuko** + 2 x **USBA**
Power supply 110-250 V AC.
UK, FRENCH and USA plug on demand.
Colors: black, white and stainless steel.

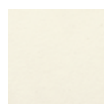


TABLE TOPS AND SHELVES X-Y-Z HPL FINISHINGS

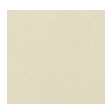
DARK CORE HPL FINISHINGS



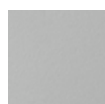
RAL 9016



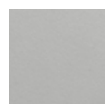
0733-810
RAL 9001



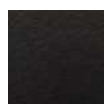
0624
RAL 1013



0741-478
RAL 7035



0074-475
RAL 7047



0077-879
RAL 7015

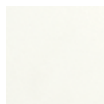


RAL 9011



0648
RAL 8019

FULL COLOR HPL FINISHINGS



RAL 9016

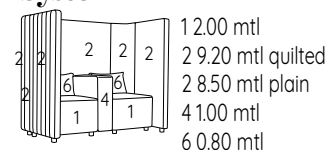
MAJI SYSTEMS



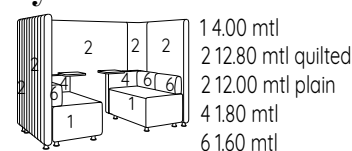
TECHNICAL DETAILS

			fabric mtl H 140 cm	leather m ²
MAJI UNIT A QUILTED	10	0.03	1.50	2.79
MAJI UNIT A PLAIN	10	0.03	1.30	2.42
MAJI UNIT B QUILTED	15	0.08	1.90	3.53
MAJI UNIT B PLAIN	15	0.08	1.80	3.35
MAJI UNIT C QUILTED	20	0.10	2.30	4.28
MAJI UNIT C PLAIN	20	0.10	2.20	4.09
MAJI UNIT D QUILTED	25	0.13	2.70	5.02
MAJI UNIT D PLAIN	25	0.13	2.60	4.84
MAJI UNIT E QUILTED	30	0.15	3.20	5.95
MAJI UNIT E PLAIN	30	0.15	3.10	5.77
MAJI UNIT F QUILTED	35	0.18	5.30	9.86
MAJI UNIT F PLAIN	35	0.18	4.90	9.11
MAJI UNIT G QUILTED	40	0.20	5.70	10.60
MAJI UNIT G PLAIN	40	0.20	5.50	10.23
MAJI UNIT H QUILTED	45	0.23	6.30	11.72
MAJI UNIT H PLAIN	45	0.23	6.10	11.35
MAJI UNIT I QUILTED	11	0.14	2.20	4.09
MAJI UNIT I PLAIN	11	0.14	1.90	3.53
MAJI UNIT L	11	0.09	1.30	2.42
MAJI UNIT M	7	0.05	1.20	2.23
MAJI UNIT N	8	0.10	1.40	2.60
MAJI UNIT T	8	0.05	1.30	2.42
MAJI UNIT O	12	0.17	1.30	2.42
MAJI UNIT P	13	0.26	2.20	4.09
MAJI UNIT Q	20	0.37	3.20	5.95
MAJI UNIT R	25	0.52	4.50	8.37
MAJI UNIT S	45	1.38	8.00	14.88
MAJI SHELVES X 100	20	/	/	/
MAJI SHELVES Y 60	15	/	/	/
MAJI SHELVES Z 30X30	10	/	/	/
MAJI TABLE	60	0.98	/	/
MAJI SYSTEM 1 QUILTED	114	2.01	11.00	20.46
MAJI SYSTEM 1 PLAIN	114	2.01	10.30	19.16
MAJI SYSTEM 2 QUILTED	176	3.40	18.20	33.85
MAJI SYSTEM 2 PLAIN	176	3.40	17.40	32.36
MAJI SYSTEM 6 QUILTED	329	7.92	40.60	75.52
MAJI SYSTEM 6 PLAIN	329	7.92	39.00	72.54
MAJI SYSTEM 7 QUILTED	247	7.28	32.60	60.64
MAJI SYSTEM 7 PLAIN	247	7.28	30.60	56.92
MAJI SYSTEM SOFA BED AR N	61	1.85	9.70	18.04
MAJI SYSTEM SOFA BED AR T	57	1.70	9.50	17.67

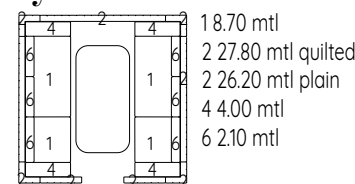
System 1



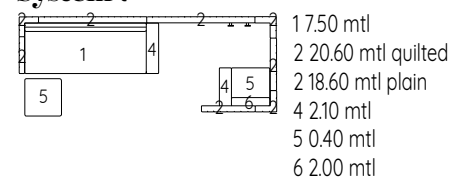
System 2



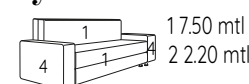
System 6



System 7



System sofa bed ar N



Sistema sofa bed ar T



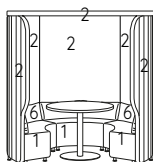
MAJI SYSTEMS



TECNICAL DETAILS

			fabric mtl H 140 cm	leather m ²
MAJI PHONE BOOTH WALL QUILTED	40	0.75	5.00	9.30
MAJI PHONE BOOTH WALL PLAIN	40	0.75	4.50	8.37
MAJI PHONE BOOTH FREESTANDING QUILTED	85	1.28	7.00	13.02
MAJI PHONE BOOTH FREESTANDING PLAIN	85	1.28	6.50	12.09
MAJI SINGLE PHONE BOOTH QUILTED	75	1.60	13.00	24.18
MAJI SINGLE PHONE BOOTH PLAIN	75	1.60	12.50	23.25
MAJI ROUND PHONE BOOTH D215 QUILTED	350	9.84	39.10	72.73
MAJI ROUND PHONE BOOTH D215 PLAIN	350	9.84	38.10	70.87
MAJI CABINET FOR PRINTERS QUILTED	200	9.61	24.50	45.57
MAJI CABINET FOR PRINTERS PLAIN	200	9.61	24.00	44.64

Round phone booth D215



15.00 mtl
 2 30.00 mtl quilted
 2 29.00 mtl plain
 6 3.60 mtl

SUGGESTED FABRICS

Fabrics



Leathers

