

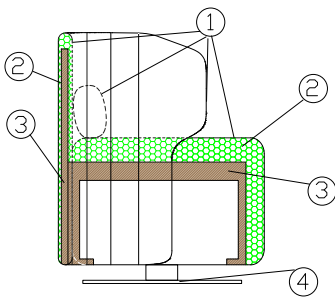

The name - Maji - comes from Japanese, and means “Really?”, an exclamation of surprise and amazement, as if it stirred questions such as “Can you actually sit in that shell? Can you really combine so many elements together?” Maji is an original modular system for office spaces or waiting areas, versatile and adaptable to any setting. It consists of a padded wall, which can be endlessly modulated, and it can wrap, as a protective shell, the most diverse elements, such as chairs, sofas, shelves, hangers.



MAJI LOW:

- 1 - dacron® fiber 100 gr;
- 2 - high resilience polyurethane foam of different densities;
- 3 - structural frame in solid firwood;
- 4 - swivel base in shiny inox and column in chrome metal.

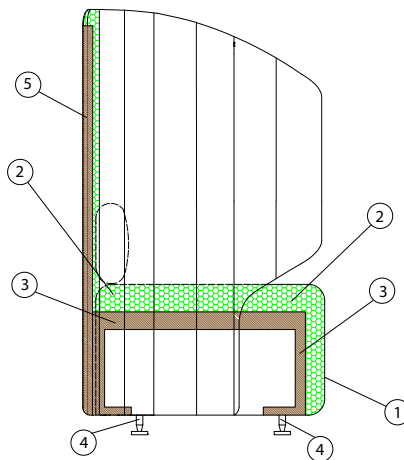

MAJI HIGH:

- 1 - dacron® fiber 100 gr;
- 2 - high resilience polyurethane foam of different densities;
- 3 - structural frame in solid firwood;
- 4 - swivel base in shiny inox and column chrome metal /chrome metal feet.
- 5 - structural frame in curved plywood.

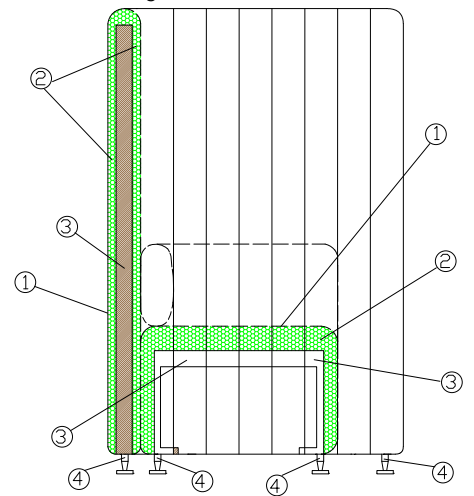

MAJI SYSTEMS:

- 1 - dacron® fiber 100 gr;
- 2 - high resilience polyurethane foam of different densities;
- 3 - structural frame in solid firwood;
- 4 - chrome metal feet.

DIMENSIONS:

Low

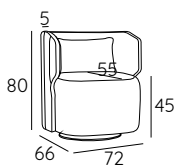

High

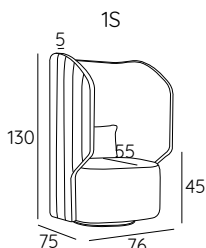

Systems

SYSTEM 1

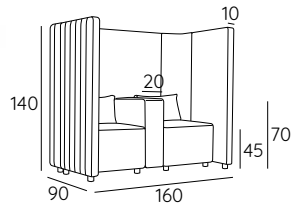

SYSTEM 2

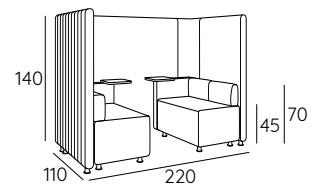

SYSTEM 3

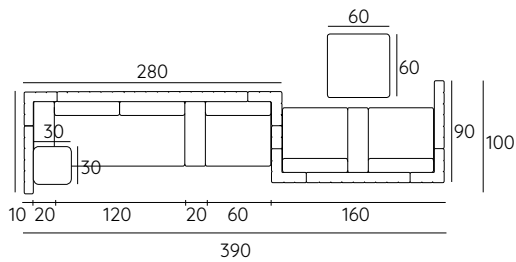
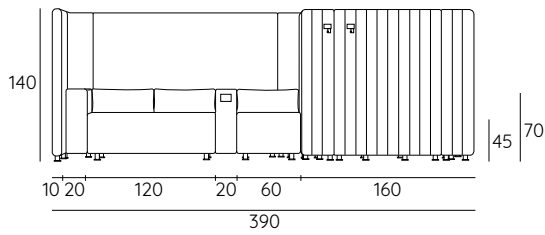

SYSTEM 6

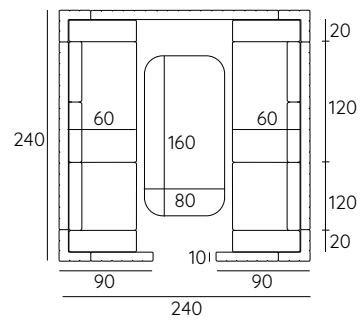
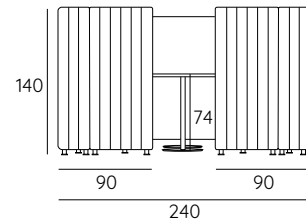

SYSTEM BED SOFA

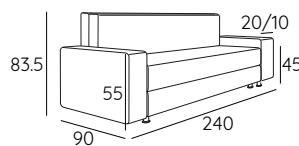

Sistema di apertura/chiusura del modulo S letto



SYSTEM 7

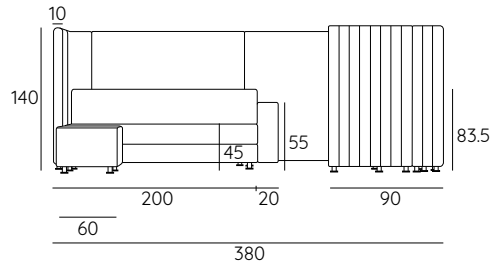

Opening/closing system
item S whit bed

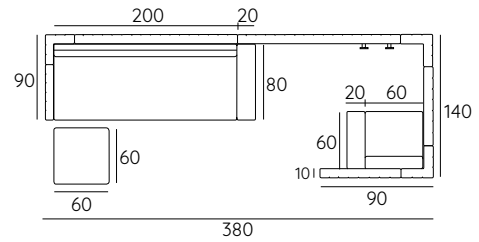

Module system

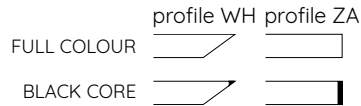
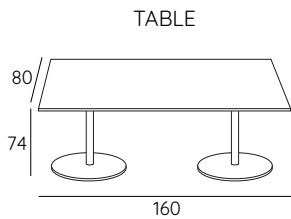
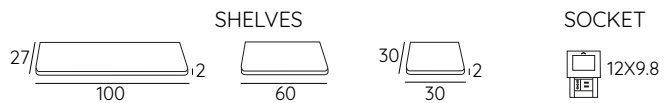
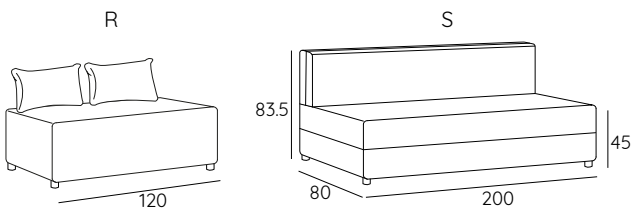
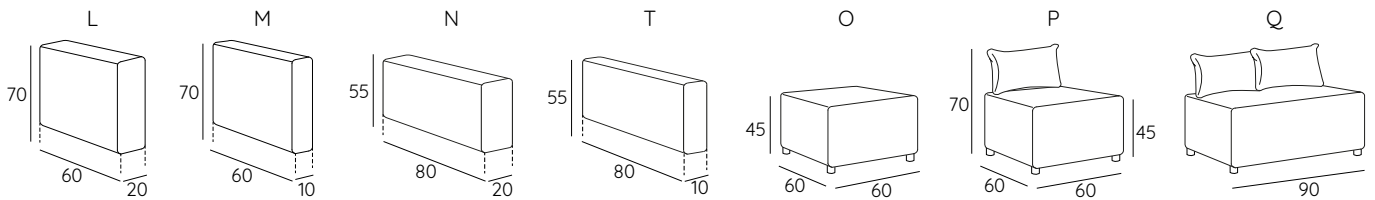
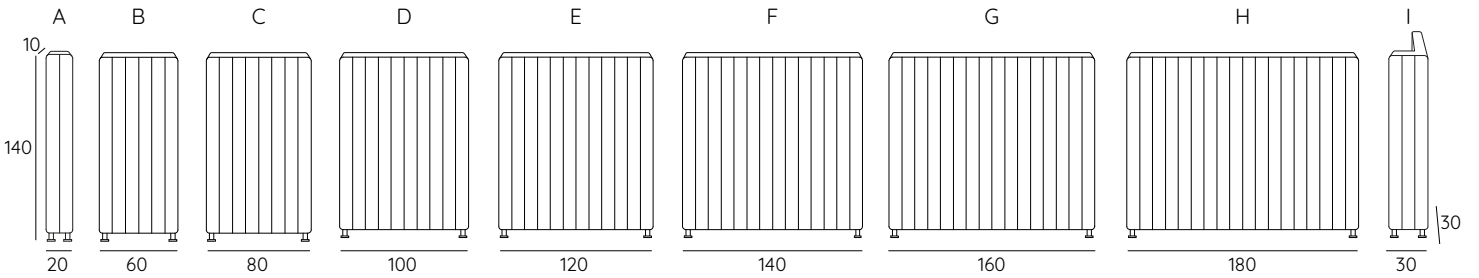

COAT HOOK

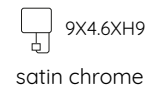

SUGGESTED CONFIGURATIONS:

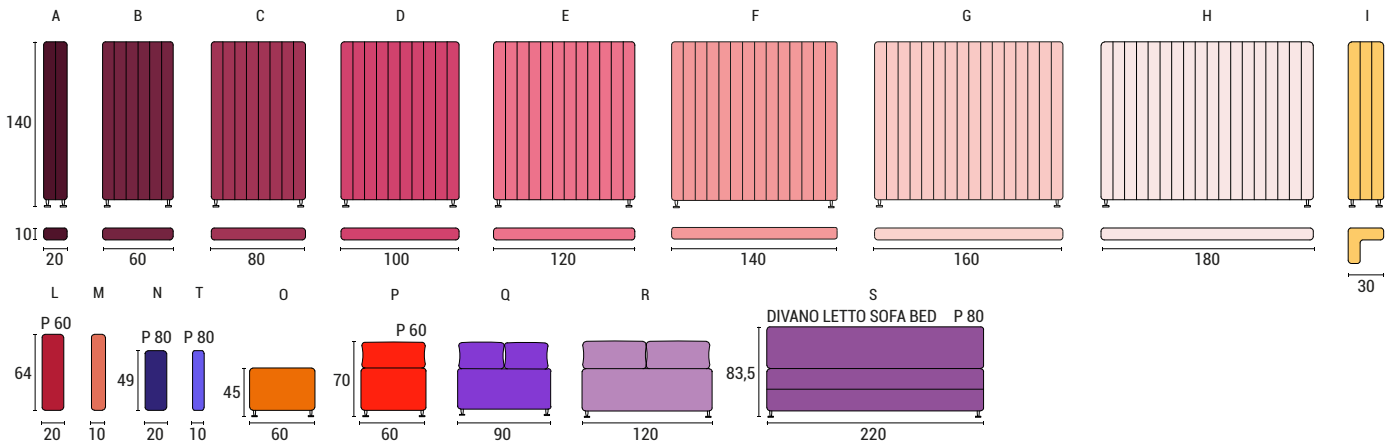

SISTEMI/SYSTEMS

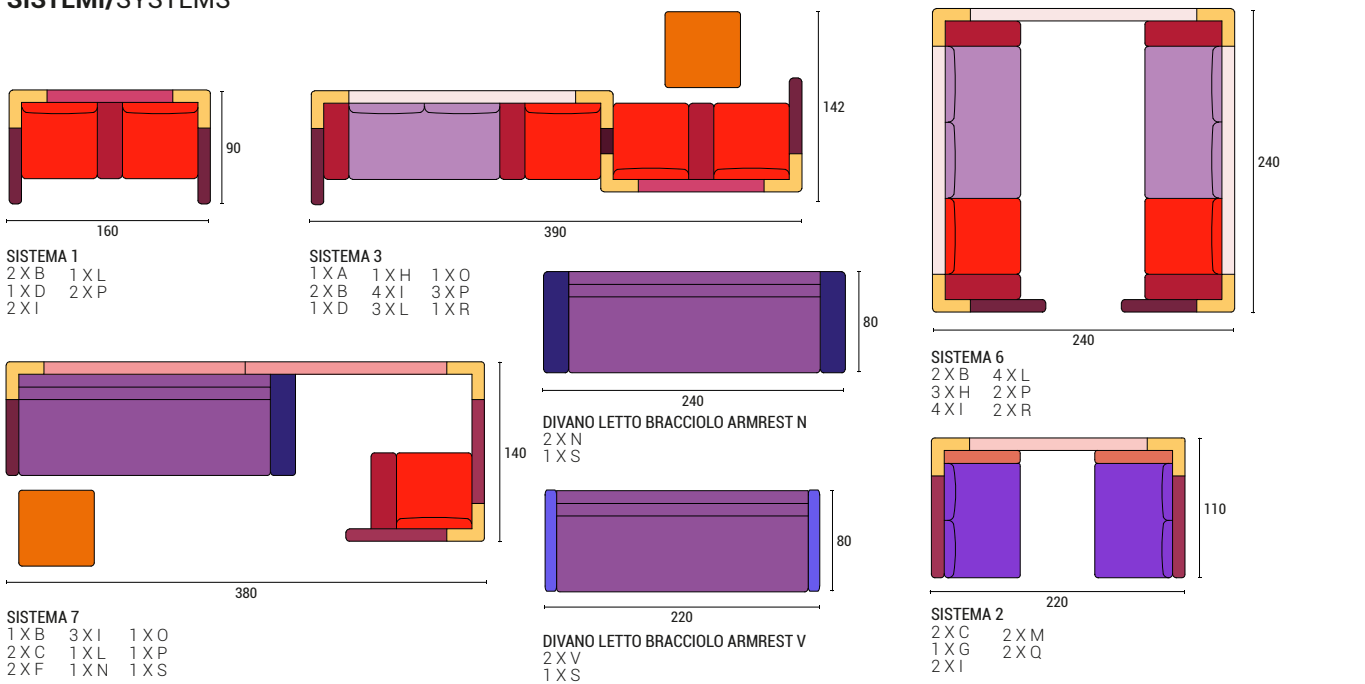

COMBINAZIONI SUGGERITE/SYSTEMS

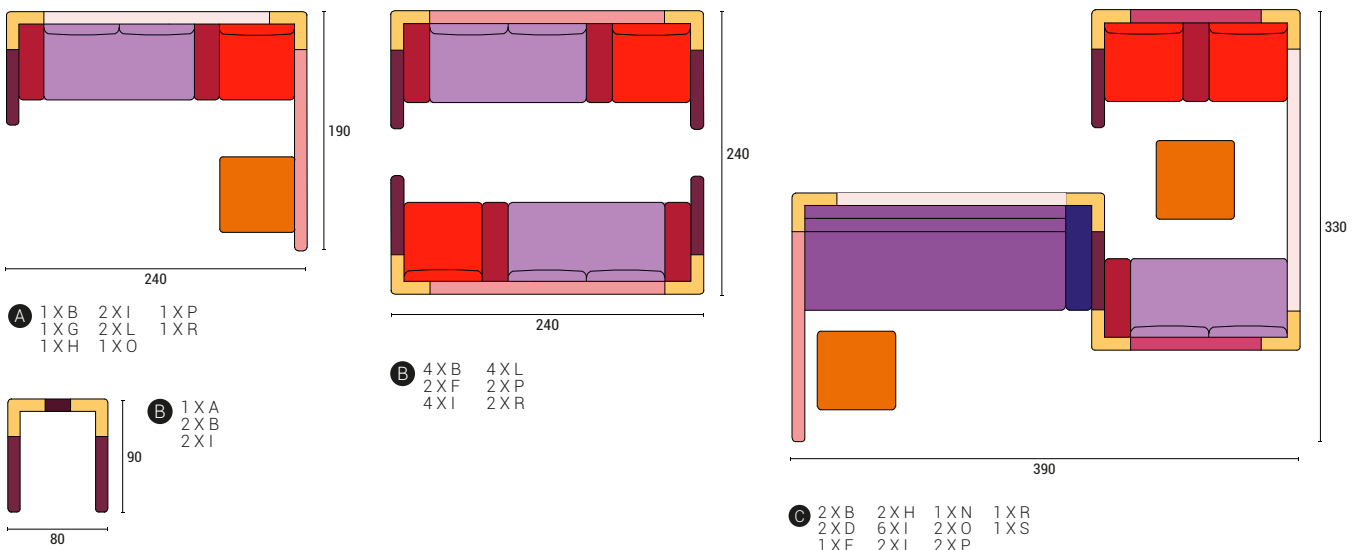

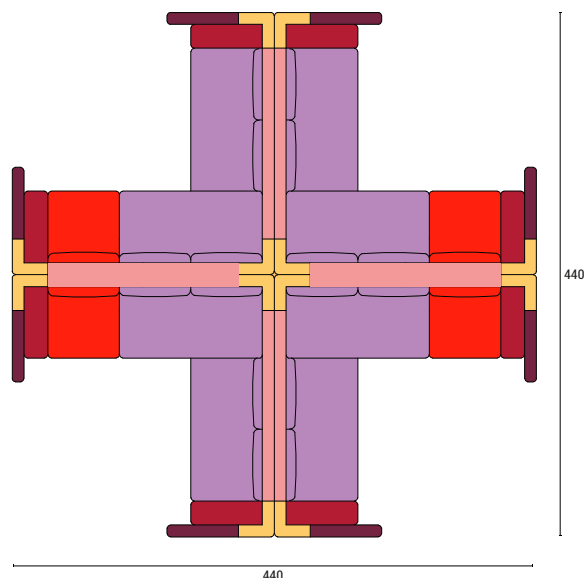

① 8XB 8XL
8XF 4XP
12XI 8XR

BASE AND FEET:

B 01 h 4



h 6



PANELS FINISHINGS:

quilted

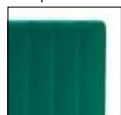

plain



TECHNICAL DETAILS:

Removable cover: NO	kg	m ³	mts		kg	m ³	mts
MAJI LOW 1P	/	0.38	(1) 3.40 (2) 1.60	MAJI MODULE O	/	0.25	1.65
MAJI HIGH 1P	/	0.74	(1) 4.90 (2) 1.70	MAJI MODULE P	/	0.50	3.90
MAJI HIGH 2P	/	1.36	(1) 6.40 (2) 2.70	MAJI MODULE Q	/	0.37	/
				MAJI MODULE R	/	1.34	/
MAJI MODULE A	/	0.02	1.00	MAJI SHELVES 100	/	0.005	/
MAJI MODULE B	/	0.08	2.00	MAJI SCELVES 60	/	0.003	/
MAJI MODULE C	/	0.11	2.30	MAJI SHELVES 30X30	/	0.001	/
MAJI MODULE D	/	0.14	3.00	MAJI TABLE	/	0.95	/
MAJI MODULE E	/	0.17	3.40	MAJI SOCKET	/	0.00081	/
MAJI MODULE F	/	0.58	/	MAJI COAT HOOK	/	0.003	/
MAJI MODULE G	/	0.22	4.40				
MAJI MODULE H	/	0.25	4.80	MAJI SYSTEMA 1	/	1.14	16.20
MAJI MODULE I	/	0.13	1.80	MAJI SYSTEMA 3	/	2.74	34.20
MAJI MODULE L	/	0.08	1.50	MAJI SYSTEMA 6	/	4.20	40.40
MAJI MODULE M	/	0.08	1.50	MAJI SYSTEMA 7	/	3.00	33.50
MAJI MODULE N	/	0.25	1.65	MAJI SYSTEMA BED SOFA	/	1.91	18.60

IP low

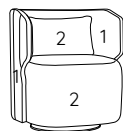

IP High

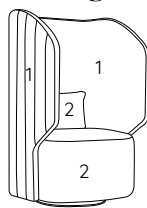

2P High

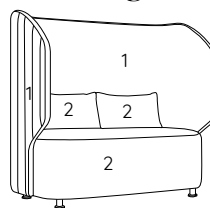

SUGGESTED FABRICS:



Lemming 29500



Luna/Z CS



Amara



Mirage



Sprint

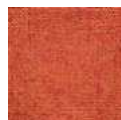

Sole CS



Nemi melange



Angel combo



Angel chevy



Angel jumbo



Europost 2



Natur wool



Fenice



Vintage



Tiffany contract



Polaris Pro



Happy

PHOTO GALLERY:



Maji low armchair



Maji high armchair



Maji high sofa

