

# TEVERE 210 EXTENSIBLE

design Raffaello Galiotto

Ref. 496

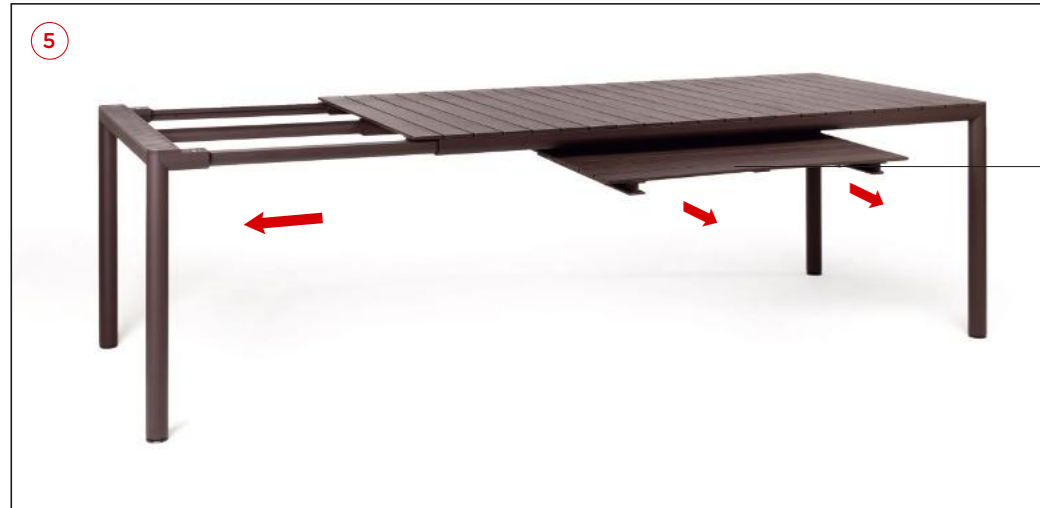

EXTENSION



x 4



**IT** Tavolo allungabile. 211-275 x 100 x 76,5h cm. Materiale: piano in polipropilene fiberglass\* trattato anti-UV e colorato in massa. Struttura in alluminio verniciato. Finitura opaca. Dotato di piedini regolabili. Istruzioni d'uso: posizionare in modo stabile su un suolo piano. Pulire con detergenti non aggressivi e sciacquare con acqua. Tipo di utilizzo: collettività. Prodotto da montare. Prodotto in Italia. Resina riciclabile. Prodotto a norma UNI EN 581/1/3. Avvertenza: rischi di pizzicamento in fase di installazione. Nardi declina ogni responsabilità per danni a persone e/o cose, o al prodotto stesso, causati dall'utilizzo improprio del prodotto.

**EN** Extensible table. 211-275 x 100 x 76,5h cm. Material: top in uniformly colored fiberglass polypropylene resins\* with UV additives. Frame in coated aluminum. Matt finish. Adjustable height feet. Instructions for use: place on a flat, level area. Wash with mild soap and rinse with water. Typical uses: group gatherings. Assembly required. Made in Italy. Recyclable resin. Product conforms to UNI EN 581/1/3. Note: there is a risk of being pinched during assembly. Nardi declines all responsibility for damage to people and/or things, or to the product itself, caused by improper use of the product.

**FR** Table extensible. 211-275 x 100 x 76,5h cm. Matériau: plateau en polypropylène fiberglass\* traité anti-UV et coloré dans la masse. Structure en aluminium vernis. Effet mat. Vérins de réglage. Instructions d'utilisation: positionner de manière stable sur un sol plan. Nettoyer le produit avec détergent non agressif et rincer avec de l'eau. Type d'utilisation: collectivité. A monter soi-même. Fabriqué en Italie. Résine

recyclable. Produit conforme à la norme UNI EN 581/1/3. Avertissement: risques de pincement en cours d'installation. Nardi décline toute responsabilité pour les dommages aux personnes et/ou aux choses, ou au produit lui-même, causés par une mauvaise utilisation du produit.

**DE** Verlängerbarer Tisch. 211-275 x 100 x 76,5h cm. Material: Tischplatte aus UV-beständigem fiberglass-Polypropylen\*, voll durchgefärbt. Gestell aus epoxiertem Aluminium. Matt-Effekt. Höhenverstellbaren Füßen. Gebrauchseinleitung: Einsatz auf ebenem Untergrund. Reinigung mit neutralem Reinigungsmittel und mit Wasser nachspülen. Nutzung: Gewerblich. Zusammensetzbarer Artikel. Hergestellt in Italien. Recyclebarer Kunststoff. Produkt entspricht der norm UNI EN 581/1/3. Achtung: Verletzungsgefahr beim Aufbau. Nardi lehnt jede Verantwortung für Schäden an Personen und/oder Gegenständen oder am Produkt selbst ab, die durch unsachgemäße Verwendung des Produkts verursacht werden.

**ES** Mesa extensible. 211-275 x 100 x 76,5h cm. Material: tablero en polipropileno fiberglass\* tratado anti-UV y teñido en masa. Estructura en aluminio pintado. Efecto mate. Tacos regulables. Instrucciones de uso: colocar en una superficie plana y estable. Limpiar el producto con detergente suave, aclarandolo posteriormente con agua. Tipo de uso: colectividades. Producto de ensamblar. Fabricado en Italia. Resina reciclable. Fabricado según normativa UNI EN 581/1/3. Advertencia: riesgo de pellizcarse al realizar el montaje. Nardi declina toda responsabilidad por daños a personas y/o cosas, o al producto en sí, causados por un uso inadecuado del producto.

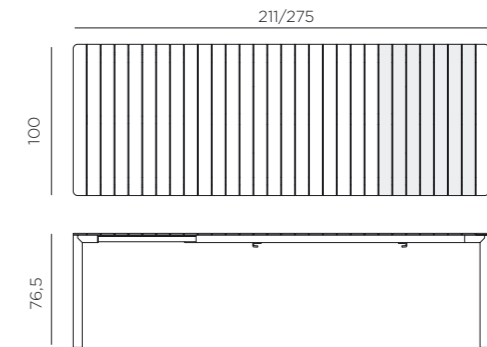

**PT** Mesa extensível. 211-275 x 100 x 76,5h cm. Material: tampo em polipropileno fiberglass\* com tratamento anti-UV colorido na totalidade. Estrutura em alumínio pintado. Acabamento fosco. Pés ajustáveis. Instruções de utilização: deve permanecer em solo estável e plano. Limpar com detergente suave e passar com água. Utilização: coletividade. Requer montagem. Fabricado em Italia. Resina reciclável. Produto conforme norma UNI EN 581/1/3. Aviso importante: perigo de corte e entalamento durante a instalação. A Nardi declina qualquer responsabilidade por danos a pessoas e/ou coisas, ou ao próprio produto, causados pelo uso indevido do produto.

\* **IT** Nella versione colore Terra il piano è in polipropilene fiberglass RIGENERATO. Il polipropilene fiberglass rigenerato può subire delle variazioni di colore dovute all'utilizzo di materiale riciclato. **EN** In the Terra colour version, the top is made of REGENERATED fiberglass polypropylene resins. Regenerated fiberglass polypropylene may undergo variations in color due to the use of recycled material. **FR** Dans la version couleur Terra, le plateau est en polypropylène fiberglass RÉGÉNÉRÉ. Polypropylène fiberglass régénérée peut subir variations de couleur en raison de l'utilisation de matériaux recyclés. **DE** In der Ausführung mit der Farbe Terra besteht die Tischplatte aus REGENERIERTEM fiberglass-Polypropylen. Regeneriertem fiberglass-Polypropylen kann aufgrund der Verwendung von recyceltem Material Farbabweichungen unterliegen. **ES** En la versión color Terra el tablero es de polipropileno fiberglass RIGENERADO. El polipropileno fiberglass regenerado puede sufrir variaciones de color debido al uso de material reciclado. **PT** Na versão cor TERRA o tampo é de polipropileno fiberglass RIGENERADO. O polipropileno fiberglass regenerado pode sofrer variações de cor devido ao uso de material reciclado.

For recycling information [www.nardioutdoor.com/packaging](http://www.nardioutdoor.com/packaging)





10



**IT** NARDI NON RISponderà DI EVENTUALI DANNI CAUSATI IN FASE DI ASSEMBLAGGIO.  
**EN** NARDI SHALL NOT BE HELD LIABLE FOR ANY DAMAGE CAUSED DURING ASSEMBLY OPERATIONS.  
**FR** NARDI N'EST PAS RESPONSABLE DES DOMMAGES CAUSÉS LORS DE L'ASSEMBLAGE.  
**DE** NARDI HAFtet NICHT FÜR EVENTUELLE WÄHREnd DER MONTAGE VERURSACHTE SCHÄDEN.  
**ES** NARDI NO SERÁ RESPONSABLE DE LOS DAÑOS PRODUCIDOS DURANTE EL MONTAJE.  
**PT** A NARDI NÃO SE RESPONSABILIZA POR QUAISQUER DANOS CAUSADOS DURANTE A MONTAGEM.

IMPORTANTE, CONSERVARE PER FUTURI RIFERIMENTI: LEGGERE ATTENTAMENTE. • IMPORTANT, RETAIN FOR FUTURE REFERENCE: READ CAREFULLY. • IMPORTANT-À CONSERVER POUR DE FUTURS BESOINS DE RÉFÉRENCE: À LIRE SOIGNEUSEMENT. • WICHTIG BITTE AUFMERKSAM DURCHLESEN UND GUT AUFBEWAHREN. • IMPORTANTE GUARDAR PARA FUTURAS CONSULTAS: LEER ATENTAMENTE. • IMPORTANTE CONSERVE PARA FUTURAS REFERÊNCIAS: LEIA ATENTAMENTE.

COMPONENTI, COMPONENTS, COMPOSANTS, KOMPONENTEN, COMPONENTES, COMPONENTES.

|     | A   | B   | C   | D  | E   |
|-----|---|---|---|--|---|
|     |  |  |  |  |  |
|     | M4,5 x 50   |   |   |  |   |
| pcs | 4   | 4   | 1   | 1  | 3   |

ASSEMBLAGGIO, ASSEMBLY, ASSEMBLAGE, MONTAGE, ENSAMBLAR, MONTAGEM.

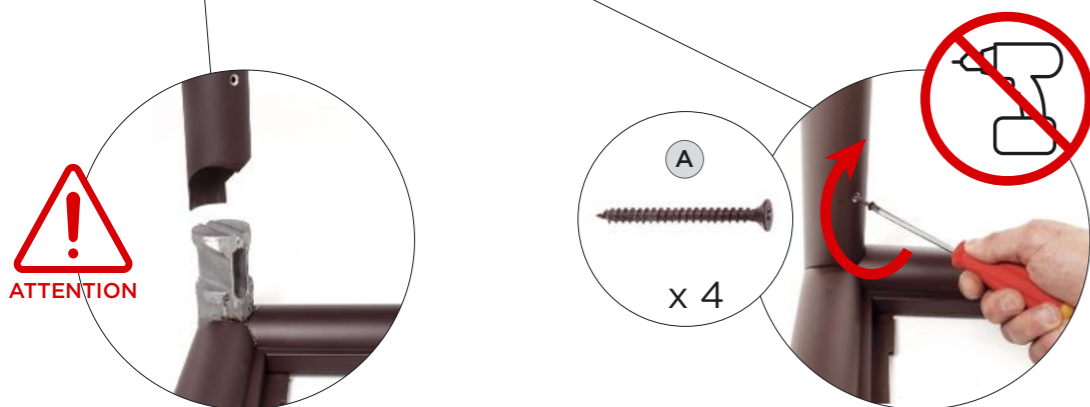
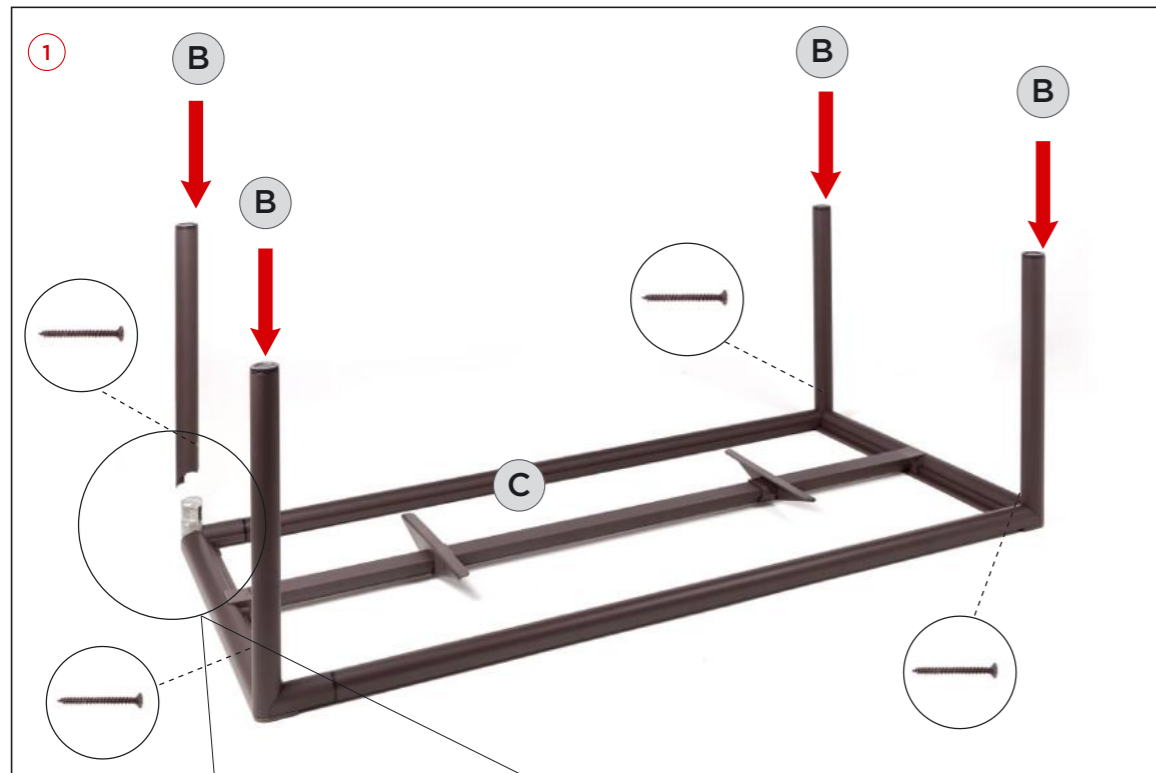

IT Allineare correttamente la gamba al supporto.  
 EN Line up the leg correctly with the support.  
 FR Aligned correctement le pied avec le support.  
 DE Richten Sie das Bein korrekt mit der Stütze aus.  
 ES Alinea la pata correctamente con el soporte.  
 PT Alinhe corretamente a perna com o suporte.

IT NON USARE AVVITATORE ELETTRICO. Usare un semplice cacciavite.  
 EN DO NOT USE AN ELECTRIC SCREWDRIVER. Use a standard screwdriver.  
 FR NE PAS UTILISER DE VISSEUSE ÉLECTRIQUE. Utiliser un tournevis.  
 DE KEINEN ELEKTROSCHRAUBER VERWENDEN. Einen einfachen schraubendreher verwenden.  
 ES NO UTILIZAR UN ATORNILLADOR ELÉCTRICO. Utilizar un destornillador común.  
 PT NÃO UTILIZAR APARAFUSADORA ELÉTRICA. Utilizar uma chave de fendas normal.

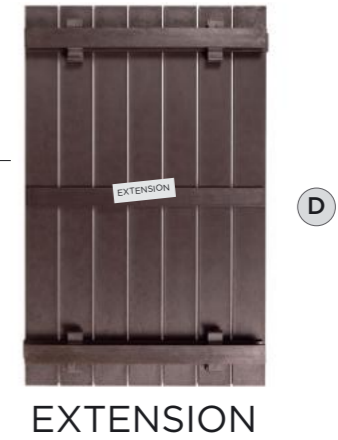

8 