

LUXMAN

CONTROL AMPLIFIER
C-10X



Breathtakingly realistic, full of harmony

A flagship model that breathes new life into the listening experience

Once you turn up the volume, you'll be captivated by the sense of reality.

A spacious sound stage opens up in front of you, filling the space beautifully.

A miraculous experience unfolds where music breathes energy into life.

What we sought for our flagship model was the ultimate expression in art form that is musical reproduction.

The C-10X is equipped with our new “LIFES” amplifier feedback engine and the latest version of our original electronically controlled attenuator, “LECUA-EX”, technologies developed to lead LUXMAN into our next century.

Fully-balanced audio pathways are directly connected throughout the three-dimensional structure, achieving infinite silence, overwhelming instantaneous power, and a true sense of realism.

This is the birth of the C-10X control amplifier, heralding a new era of pure musical reproduction.



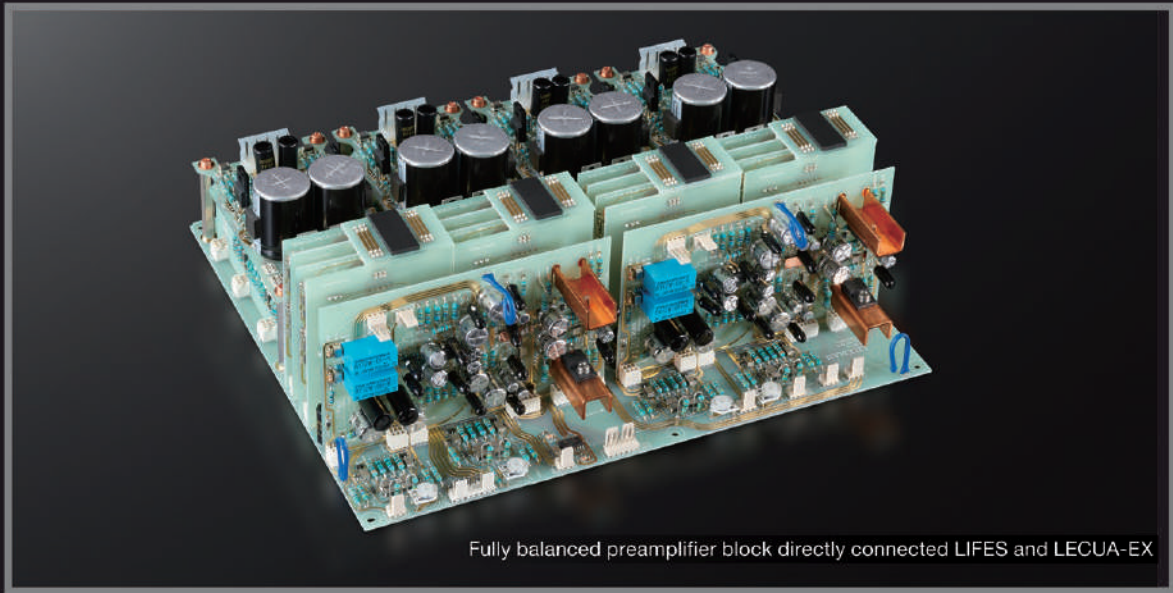

Fully balanced preamplifier block directly connected LIFES and LECUA-EX

"New amplified feedback engine"

"New computerized attenuator"

LIFES × LECUA-EX

Luxman Integrated Feedback Engine System

Luxman Electronically Controlled Ultimate Attenuator - Excellent eXperience

Direct, three-dimensional connections between fully balanced amplifier circuit and attenuator

ODNF*, a unique feedback system that has been matured as epoch-making amplifier innovation that provides the natural sound quality of a non-feedback equipped amplifier by feeding back only the distorted components of the amplified signal. In 2021, when developing our M-10X flagship power amplifier, we delivered LIFES as a new amplification feedback engine in order to acquire more realistic, fresh and rich musicality and overwhelming audio performance and now it is at the heart of our flagship C-10X control amplifier, the first model upgrade in 10 years. For the volume control system, we refined our LECUA electronically controlled attenuator that switches over a series of fixed resistors arranged in order in the circuit. LECUA-EX, which reads the motion pulses of a rotary encoder entirely disconnected from the audio signal path, thoroughly suppresses sound quality deterioration and enables smooth volume control. Our LIFES preamplifier circuit is assembled with bespoke components and is directly connected to the LECUA-EX system, the four units being laid out in a fully balanced configuration in completely identical operational states to realize the ideal structure as a preamplifier.

Various control functions for controlling the audio system

As a flagship model that stands at the top of our lineup, the C-10X not only has high-performance preamplifier circuitry that confidently drives the power amplifiers connected in the following stage, but also has a rich array of functions as a control center that adjusts the environment of the entire audio system. Preamplifier gain has been increased to 15dB (previous model C-900u had 12dB), allowing accurate handling of a wide range of levels from various input sources without distortion. In addition to a variety of output mode switching functions that allow you to select unbalanced, balanced or bi-amplified configuration, depending on your system, you can also use the volume shift function in 0.5dB steps via the electronically controlled attenuator LECUA-EX main volume control system. This allows you to adjust left and right balance (L: -6dB to R: +6dB) without causing deterioration, adjust the level for each output system in bi-amp mode (±6dB for each system) and adjust the output level for different listening situations. If it also equipped with an input offset function (0 to -6dB for each input terminal) that allows you to align the levels of multiple input devices, achieving a wide variety of control functions despite its simple circuit configuration.

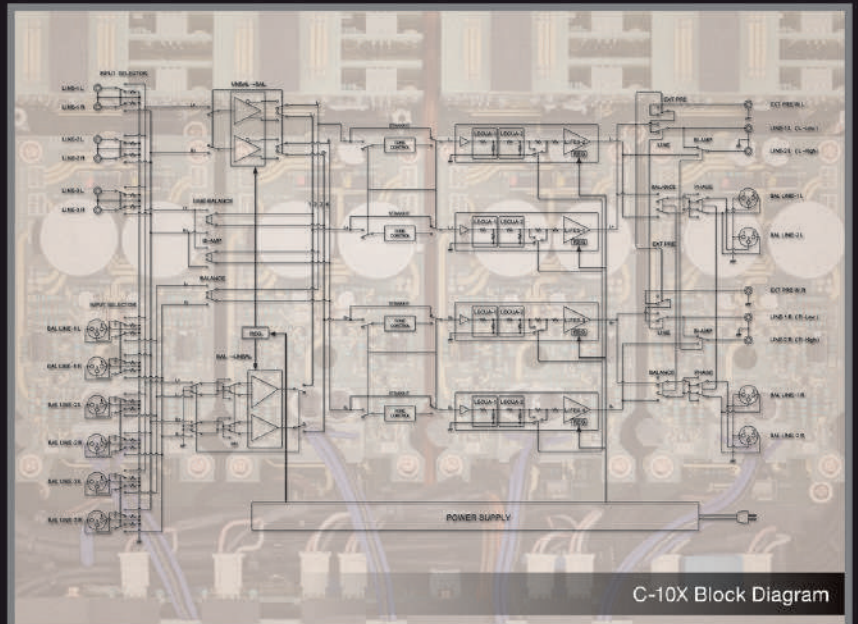

C-10X Block Diagram

*ODNF stands for "Only Distortion Negative Feedback"



Front panel with slanted sides

Panel configuration with beautiful contrast

The C-10X expresses bold and delicate slanted edges between the chassis and the front panel. The three dimensional and sensual housing design, common to both the M-10X and D-10X, embodies the overwhelming presence and high musicality of a flagship model. The finely machined, hairline finished aluminum top panel creates a beautiful contrast to the blasted white front panel.

Fluorescent display with excellent visibility

The fluorescent display features a dimmer function and shines against the blasted white finished front panel with excellent visibility. We have also taken into consideration ease of viewing from the listening position. Normally this would display input and output volume levels, but from the remote control, the volume level display input and output volume levels, but from the remote control, the volume level display can be zoomed to four times the size. Additionally, the status of various function switches can be checked with LED indicators inside the acrylic panel.



Fluorescent display with excellent visibility



Dedicated aluminum remote control RA-20

Abundant functions and easy-to-operate remote control

The C-10X features an electronically controlled bass/treble tone control, a volume-linked loudness function that matches human hearing characteristics, an external pre-input terminal that can directly connect to the pre-output of an AV amplifier. A balanced connection phase preset function that can be set independently is provided. Also included is an aluminum remote control that providing comfortable operation of most of the C-10X's functions at your fingertips.



Rotary encoder and weighted rotation mechanism

Newly developed weight rotation mechanism

The LECUA-EX volume control combines a high-precision rotary encoder with a newly developed weighted rotation mechanism to achieve high reliability and a high-quality feel as you rotate the large, machined aluminum knob over 192 discrete steps from 0 to 95.5dB. A tactile setting that smoothly accelerates the volume increase/decrease by increasing rotation speed or pressing and holding the remote control, provides a comfortable volume operation that surpasses conventional volume devices that use variable resistors.

Highly regulated power supply

In order to embody the idea of abundant energy that accurately drives the power amplifier stage within sufficient margins, the power supply section of the C-10X is equipped with a powerful CI core type power transformer and seven custom specified 3,300 μ F filter capacitors achieve dedicated highly stable power supply smoothing for each channel. Clean and stable regulation suppresses voltage fluctuations due to load.

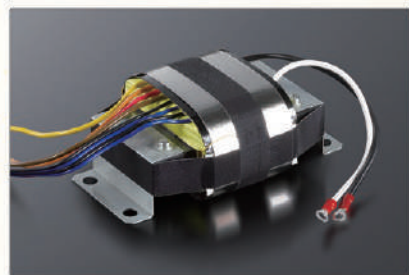

Large capacity CI core power transformer

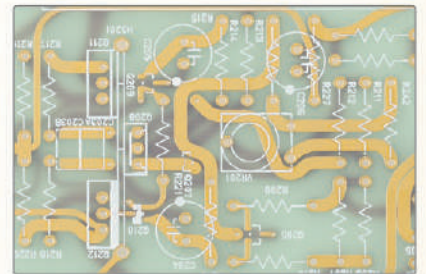

Peel coat/non-resistive board

100 μ m thick non-angled wiring pattern

All audio circuit boards in the C-10X uses a 100 μ m-thick non resistive gold-plated peel-coated substrate that eliminates the resistivity coating which adversely affects sound quality due to dielectric effects. LUXMAN's original know-how in pursuit of high sound quality is also seen in the original non-angled wiring pattern that achieves smooth and stress-free signal transmission by keeping the trace width of the signal line as constant as possible and drawing a smooth curve.



Components chosen for sound quality

Carefully selected, high-quality components

For the capacitors and resistors in the audio signal path, we have used a large number of custom designed components that prioritize sound quality. Original OFC cable is used for internal wiring. Input and output sections on the rear panel are equipped with 27mm pitch, robust RCA terminals and high-quality Neutrik XLR terminals to contribute the high standards of the C-10X.

A loop-less metal chassis structure

The metal housing features a loop-less chassis structure that will not generate a ground loop and also isolates the effects of generated magnetic fields and the rise in ground impedance due to chassis current. The C-10X is equipped with large, density gradient cast iron feet that protect delicate music signals from unnecessary vibration by firmly dampening vibrations generated internally, while also blocking external vibration.



Density gradient cast iron insulator feet

CONTROL AMPLIFIER

C-10X

CONTROL AMPLIFIER
C-10X

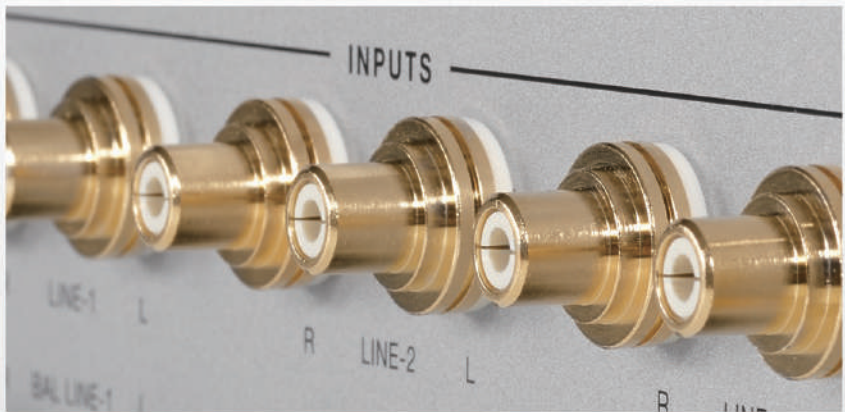
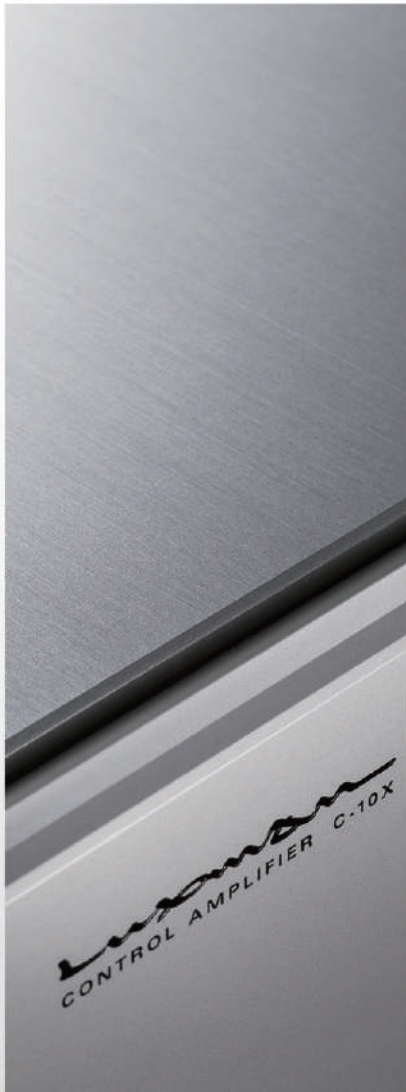
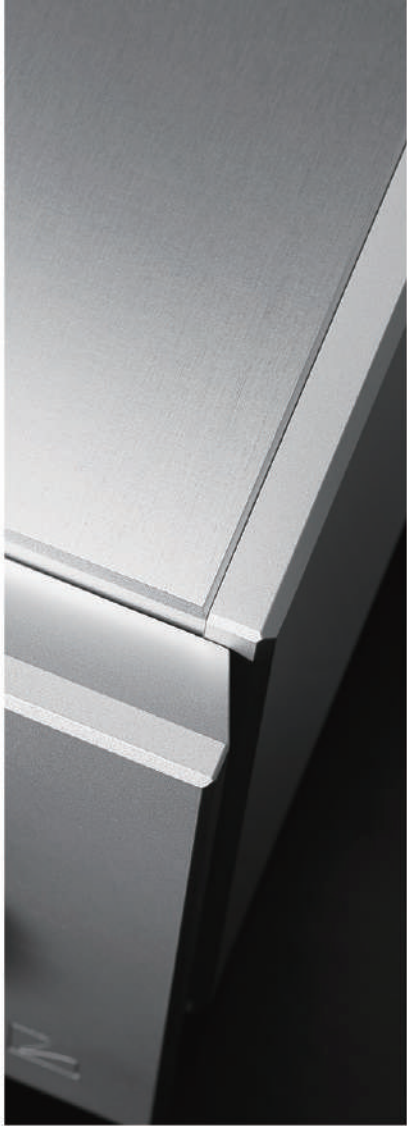

C-10X CONTROL AMPLIFIER

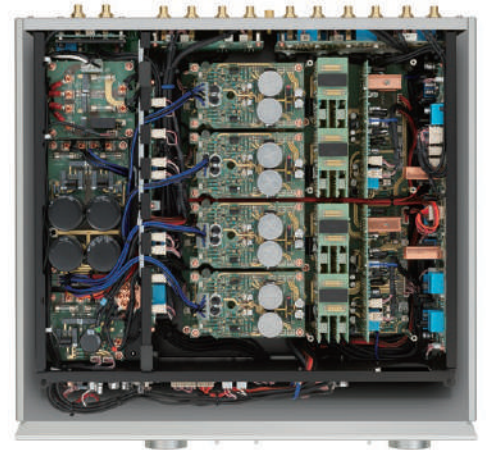
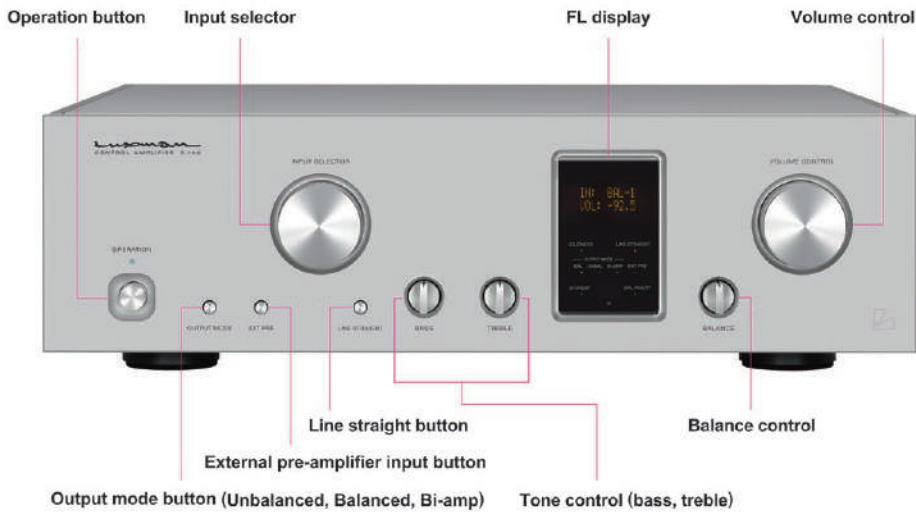

Internal configuration

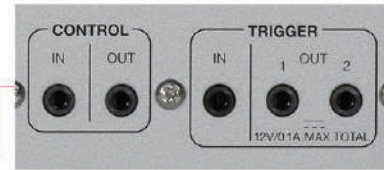
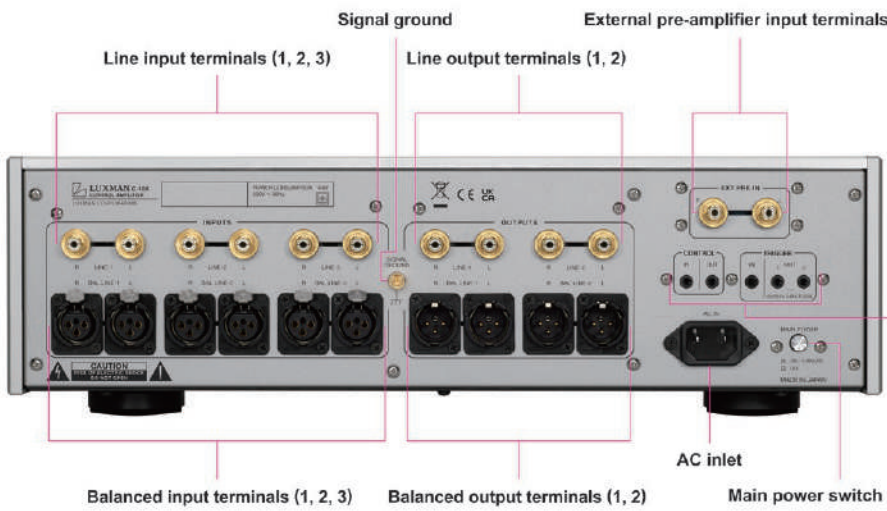

Control input / output terminal
Remote control operations can be sent to a compatible LUXMAN product connected via commercially available 3.5mm monoaural mini jack cable.

12 Volt trigger input / output terminal
Powering on and off compatible devices can be achieved via connections over a commercially available 3.5mm monoaural mini jack cable.



Remote control RA-20

For balanced inputs and outputs, the reversible phase preset (No.3HOT<->No.2 HOT) for each pair of terminals is switchable via the remotecontrol.

*Rear panel : European Model

SPECIFICATIONS

Input sensitivity/	Unbalanced 180mV/45kΩ
Input impedance	Balanced 180mV/90kΩ
Output/Input impedance	Unbalanced rating 1V/90Ω, max. 14.1V Balanced rating 1V/180Ω, max. 28.7V
Frequency response	20Hz to 20kHz (+0, within -0.1dB) 5Hz to 110kHz (+0, within -3.0dB)
Total harmonic distortion	Unbalanced 0.005% (20Hz to 20kHz) Balanced 0.003% (20Hz to 20kHz)
S/N ratio (IHF-A)	Unbalanced 129dB Balanced 132dB
Volume control	LECUA-EX
Amplification feedback circuit	LIFES 1.0
Max. change amount of tone control	BASS: ±8dB at 100Hz TREBLE: ±8dB at 10kHz

Remote control functions	Operation, Dimmer, Input selector Output mode (Unbalanced, Balanced, Bi-amp) Balanced phase switching Channel preset (Balanced phase setting, Input level offset setting, Bi-amp output level setting) External pre-amplifier input Line straight, Loudness, Volume up/down, Mute Zoom display
Power consumption	40W, 2.8W (at standby)
External dimensions	440(W) x 130(H) x 434(D) mm front side knob of 16mm and rear side terminal of 15mm included in depth
Net weight	19.8kg (main unit)
Accessories	Remote control (RA-20), Power cable

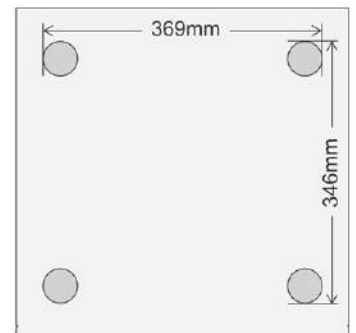

Insulator position / dimensions

LUXMAN

LUXMAN CORPORATION, 1-3-1 Shinyokohama, Kouhoku-ku, Yokohama-shi, Kanagawa 222-0033, Japan
Tel: +81-45-470-6980 Fax: +81-45-470-6997 www.luxman.com
LUXMAN reserves the right to alter the design and specifications without notice.
All rights reserved LUXMAN CORPORATION



Safety Cautions

To ensure correct use of this product, read the "Owner's Manual" prior to use. Failure to follow all safeguards can result in fire, electric shock, or other accidents.