

LUXMAN

BELT DRIVE ANALOG PLAYER  
**PD-191A**





# LUXMAN introduces the PD-191A, a premium turntable system designed to replace the long running PD-171 series.

Savor the endlessly rich warmth of a piece of music

and that special sense of time flowing differently when you play a cherished analog recording.

PD-191A is a superb player capable of delivering the excellence of vinyl recordings playback experiences.

Our newly developed, original tonearm, with extremely high initial sensitivity, uses a knife-edge vertical bearing system to realize those sensitive movements that make up the finest nuances of a musical moment.

Combining a silent and refined DC motor belt-drive system supported by a robust power supply;

PD-191A offers a truly high-fidelity and emotional vinyl listening experience.



Phono cartridge and analog record are not included.

## Multiple integrated vibration damping structures

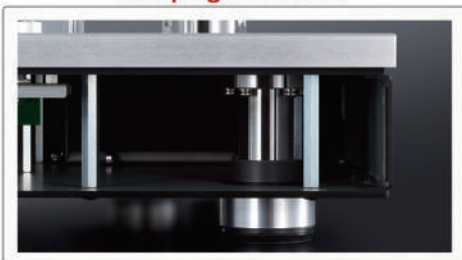

The underslung suspension structure, in which the main components are attached to a 15mm thick aluminum plate, has succeeded in achieving both high rigidity and damping performance. Also, by mounting the motor drive system and power transformer on an extra thick bottom plate, insulated with damping rubber, delicate signal pickup is protected from external vibrations, greatly improving the mechanical S/N ratio (rumble) and feedback resistance.

## Three selectable rotation speeds with pitch control and stroboscope indicator

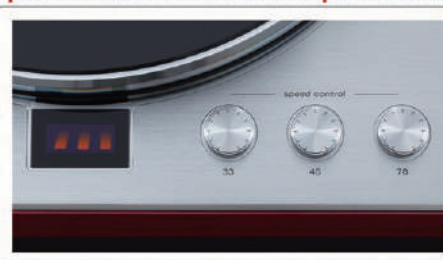

The PD-191A supports 3 rotation speeds, 33  $\frac{1}{3}$ , 45 and 78 RPM. To visualize the rotation speed, we have adopted a reflected LED stroboscope, which was well received with the earlier PD-171 series. The new strobe reflecting strip pattern has enhanced visibility and, by utilizing a dedicated control for each individual rotation speed, more reliable and precise rotation speed adjustments are possible.

## Original anti-vibration design



In order to maintain horizontal alignment, the PD-191A incorporates special damping rubber with excellent temperature characteristics and resistance to long-term deterioration into our originally designed, large-diameter insulator legs that can each be level adjusted up to 5mm in height to prevent the transmission of feedback and external vibrations.





## Newly developed, completely original tonearm

Specially developed for the PD-191A is our LTA-710 static balanced tonearm which employs knife-edge bearing technology for excellent initial movement sensitivity. A joint development with the audio brand SAEC, who have been designing tonearms for more than 40 years, the LTA-710 brings many highly regarded technologies to the LUXMAN turntable family. A fully-fledged original arm design that required two and half years to develop. By setting the effective arm length to 10 inches, tracking errors are further suppressed and resistance to vinyl surface vibration effects is enhanced. Even the gentlest of musical signals picked up by the phono cartridge from the grooves on the record are reproduced faithfully. In addition, the LTA-710 supports detailed settings such as stylus pressure, anti-skating, height adjustment according to the cartridge to be installed, etc., which is possible only because the tone arm is assembled with high mechanical precision to thoroughly maintain playback fidelity.

\*The SAEC brand is owned by Saec Commerce Co., Ltd.

## Brushless DC motor and high-capacity power supply

The drive motor is one fundamental component of a belt-drive analog player where powerful and stable platter rotation is of paramount importance. The PD-191A features an original, high-precision, high-torque, brushless DC motor supported by a float-mounted, highly stable and fully regulated large-capacity power transformer that has been upgraded to higher specifications for today's favored high-mass platters. Our sine wave PWM/PID rotation speed control\* programming achieves constant and accurate rotation control under various demands and a high-performance reference clock for speed correction, using a MEMS oscillator with excellent temperature characteristics, is deployed. As a result, precise speeds and quiet platter drive are assured.

\*PID rotation speed control: "Proportional: Proportional operation" fast adaptation to the target rotation speed, "Integral: Integral operation" Control system to correct minute errors, "Differential: Differential operation" rapid auto adjusting for speed fluctuations. The PD-191A programming system fully integrates these controls with the drive motor unit.

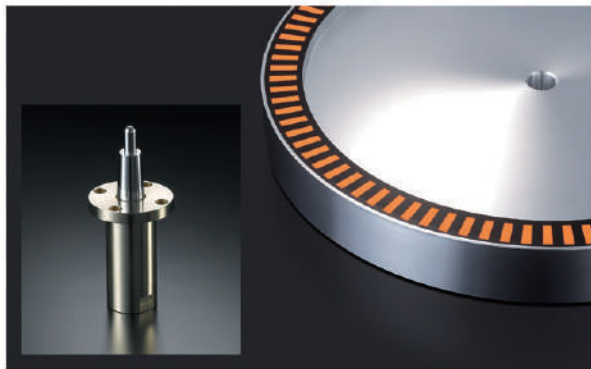

## A heavyweight, high-mass platter with a huge moment of inertia

The platter chosen for the PD-191A is a 35mm-thick, 5.2kg heavyweight disk, machined from a single, extremely thick aluminum billet, precisely diamond cut and finished to exact surfaces which beautifully reflect light. The platter acts as a flywheel with a huge moment of inertia of 0.7t-cm<sup>2</sup>, delivering smooth and confident rotation. The spindle supporting the platter boasts high-rigidity specifications with its high-tensile strength stainless steel shaft (diameter 16mm) and a customized bearing support system. This structure combines a PEEK\* thrust bearing, with its excellent heat resistance and wear resilience to a matched brass radial bearing filled with organic molybdenum oil that maintains stable lubrication even under high loads while firmly supporting the platter. The motor's energy is transferred to the platter via an EPDM\* drive belt that is resistant to aging and accurately supports the high-torque brushless DC motor output without loss.

\*PEEK is an abbreviation for polyetheretherketone, a super-engineered plastic.

\*EPDM is an abbreviation for ethylene propylene diene terpolymer with excellent resistance to aging.

## Elegant, timeless LUXMAN industrial design, featuring a wood front-panel and low center-of-gravity chassis

Our selection and finishing of the external and structural materials that make up the finished product are highly important to us as we feel that the listener's operation of an analog player should be a tactile and visually satisfying experience. A feast for the eyes, the PD-191A is elegant and sophisticated, with a rosewood-stained, solid natural wood front panel with a beautiful glossy finish, contrasting with the finely hairline-treated aluminum top panel. In addition, by offsetting the mounting of the motor inside the lower chassis, we realized a stylish, low center of gravity form with a total height 12mm lower than the earlier PD-171A. In addition, by focusing on the operational systems, such as power supply, turntable start/stop, rotation speed switching and adjustment on the top panel, we have pursued utilitarian and functional beauty. Sold separately is an available and highly recommended purpose-built 4mm thick acrylic dust cover equipped with cam/spring supporting hinges for easy opening and smooth closure.



### Headshell and phono cable



Our original lightweight aluminum headshell bearing the LUXMAN logo has unique specifications and features D.U.C.C. conductors for the lead wires. An aluminum EP adapter and a standard 5Pin (DIN type) to RCA phono cable using audio grade OFC wire are also included. Aftermarket cable replacement upgrades are possible.

### AC inlet and power cable



The AC inlet is gold-plated to reduce contact resistance and the entire terminal has been improved and reverse mounted in order to support a heavyweight AC cable.

### Abundant options for tonearm mounting



By making the arm base independent, it is easy to install various tonearms (9 to 10 inches) from different manufacturers (separately sold tone arm bases are common for the PD-171A/AL). At the rear of the main unit, an external arm base that supports a 12-inch tonearm (initially designed for the SME 3012) is also available (sold separately) to expand your enjoyment of vinyl record playback.



# PD-191A BELT DRIVE ANALOG PLAYER

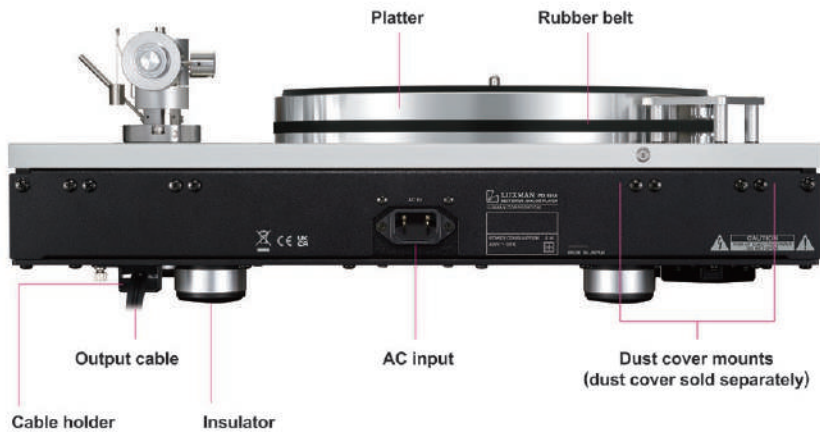
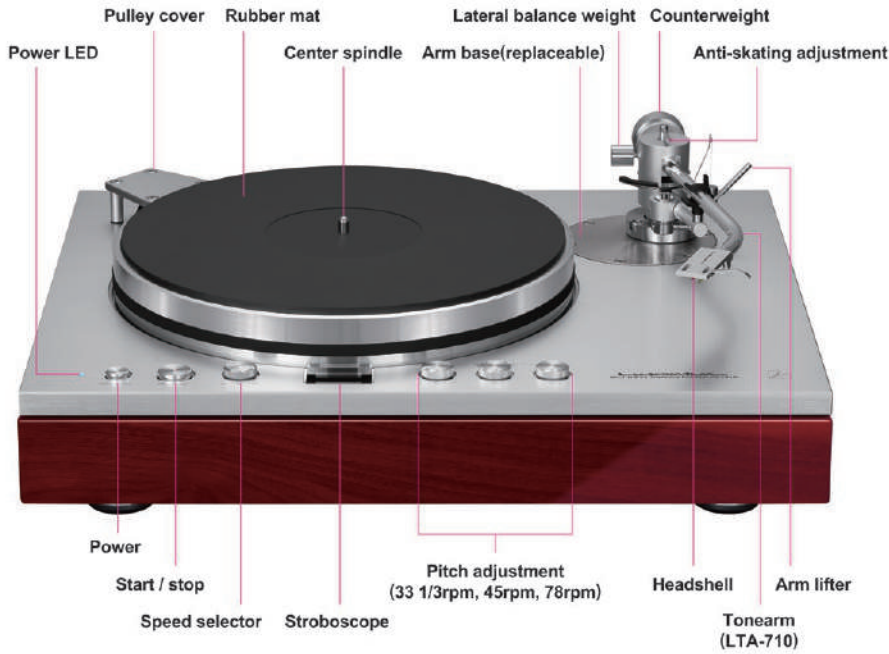

## SPECIFICATIONS

Turntable drive section	
Drive system	Belt drive system
Motor	Brushless DC motor with PID control
Material	Machined aluminum, Surface finish: Diamond cut
Revolution	33 1/3rpm, 45rpm, 78rpm (3 speeds selectable)
Revolution adjustment range	±6% (each rotation speed adjustable independently)
Wow and flutter	0.04% or less (W.R.M.S.)
Weight	5.2kg (Platter)

Tonearm section	
Type	Static balanced, S shaped, universal type
Bearing	Concealed vertical knife edge
Effective length	256mm
Overhang	16mm
Tracking error angle	+1.07° to -1.52°
Applicable cartridge weight	4 to 11g (including headshell 17 to 24g)
Adjustable height range	22mm
Anti-skating	0 to 4g

Main unit	
Power source	230V~50Hz / 115V~60Hz
Power consumption	5W
Dimensions	491(W) × 128(to the upper surface of the platter) (H) × 399(D) mm
Net weight	24.8kg (main unit), 26.4kg (with dust cover)
Accessories	Platter, Headshell (D.U.C.C lead wire included) Rubber mat, Rubber belt, Platter mount handle (2 pieces), EP adaptor, Counterweight, Anti-skating weight, Arm adjustment hex wrench set (2 types) Flathead screwdriver for rotation speed adjustment Arm base removal hex wrench, Phono cable (DIN→RCA : already installed in the unit), Power cable

\*D.U.C.C. is a registered trademark of Mitsubishi Cable Industries, Ltd.

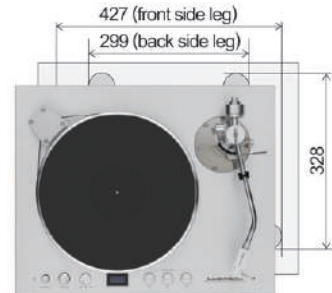

Insulator position / dimensions  
[all dimensions are in millimeters]



Dust cover  
(sold separately)

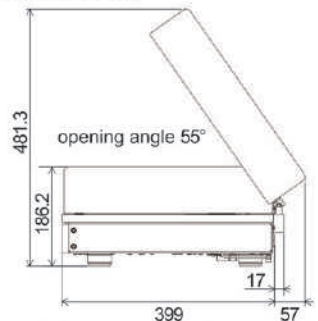

Dimensions with dust cover open  
[all dimensions are in millimeters]

### Accessories (available as service parts)

<p>Dust cover OPPD-DSC191 Specific to the PD-191A 4mm thick acrylic, cam support hinges</p>	<p>Heavy counterbalance weight OPPD-HW3 Specific to the PD-191A For cartridges of 10 to 19g (23 to 32g including headshell)</p>	<p>Replacement arm base with brass chrome-plated finish</p>			
<p>Headshell OPPD-SH3 Machined aluminum, 13g (including D.U.C.C. lead wires)</p>	<p>Rubber drive belt</p>	<p>OPP-AB1 For SME 3009R/3010R, Series M2-9R/9/10/IV/V</p>	<p>OPP-AB2 For FR 64/64S/64FX, IKEDA IT-345</p>	<p>OPP-AB3 For SAEC WE-308</p>	<p>OPP-AB4 For SAEC WE-407/23</p>
		<p>OPP-AB5 For ORTOFON 212S/212D</p>	<p>OPP-AB6 DIY universal tonearm base</p>	<p>Long arm base OPPD-AB11L For SME 3012 (12 inches) Specific to the PD-191A</p>	

### MC PHONO CARTRIDGE

## LMC-5



Cross-shaped iron core MC type phono cartridge with structural walls that suppress resonance and reflected sound

# LUXMAN

LUXMAN CORPORATION, 1-3-1 Shinyokohama, Kouhoku-ku, Yokohama-shi, Kanagawa 222-0033, Japan  
Tel: +81-45-470-6980 Fax: +81-45-470-6997 www.luxman.com

LUXMAN reserves the right to alter the design and specifications without notice.  
All rights reserved LUXMAN CORPORATION

### ⚠ Safety Cautions

To ensure correct use of this product, read the "Owner's Manual" prior to use. Failure to follow all safeguards can result in fire, electric shock, or other accidents.

