



Lifeline system

AIO

The classic safety system



+43 7619 22 1 22 - 0

+49 271 23 41 94 - 0

+43 564 16 9 042 - 0

office@innotech.at

www.innotech.at

Laizing 10

A 4656 Kirchham

AIO lifeline system

The proven lifeline system with many variants

Through the use of a stainless steel cable, the AIO lifeline system enables guided, secured movement and acts simultaneously as fall protection.

By means of personal protective equipment consisting of harness and lanyard, plus an optional slider, users can attach themselves to the tensioned cable. Regardless whether used horizontally/vertically, for overhead activities, tasks on a facade or in industry, the lifeline system can be optimally adapted to the fall-risk area, thanks to its great versatility, and it is suitable for a wide number of substructures. Depending on the version of the system, the secured person may need to detach or reconnect. It has end fastenings which include tensioning elements and intermediate cable brackets, and it can be used as a restraint, fall arrest, and rescue system.

Lifeline system

Lifeline system for roof

Horizontal lifeline system

Lifeline system for facade



BENEFITS

- Optimum adaptation to complex application areas and situations, thanks to the universally usable components
- Great flexibility through fastening to a multiplicity of substructures (concrete, steel, wood, PV substructures, etc.)
- Efficient installation through wide fastening distances and modular system components
- System is simple to inspect, because fasteners are open to view

Lifeline system for roofs and facades



Designed as a three-in-one restraint, fall arrest and rescue system, the ALLinONE lifeline system can be installed horizontally, vertically, overhead and along facades.

Its universal components allow quick and easy installation without faults, even in complex areas of application. High-quality materials such as stainless steel and aluminium guarantee safety of the highest level. It can be fastened to a large number of substructures. This ability turns the AIO lifeline system into a safety system for a wide range of applications that is as versatile as it is affordable.



BENEFITS

- Universally usable components ensure optimum adaptation to complex situations and areas of application
- Fastening options for a multitude of substructures
- Efficient installation through wide fastening distances and modular system components
- System is simple to inspect, as fasteners are open to view

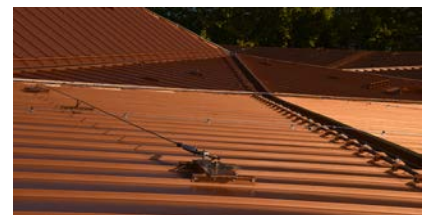

Available in a great many variants

The AIO lifeline system is available in a multitude of variants: passable horizontally, horizontally passable facade, passable overhead, non-passable horizontally, horizontally non-passable facade, vertical, IND lifeline system, and KIT BOX system. The main distinguishing feature between the individual components of these variants is their design. We will gladly help you find the variant that works best for you.

Universal lifeline system

Its modular system components make the AIO safety system suitable for universal, flexible use and allow the system to be adapted to the most complex conditions, structural shapes, and facade structures.

High-quality materials

The system components are made from high-quality and high-strength steel/aluminium.

State of the art certification:

EN 795:2012 TYPE C,
E CEN/TS 16415

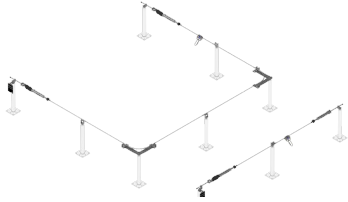

AIO-LIFELINE-SYSTEM-PASSABLE

All-in-one lifeline system, passable

For details see subsequent pages



AIO-LIFELINE-SYSTEM-PASSABLE-FACADE

All-in-one lifeline system, passable, for facade use

For details see subsequent pages

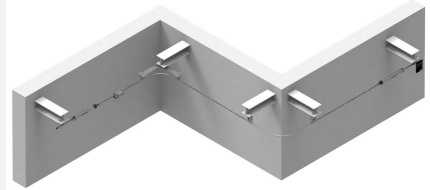

AIO-PASSABLE-OVERHEAD-LIFELINE-SYSTEM

All-in-one lifeline system, passable, for overhead use

For details see subsequent pages

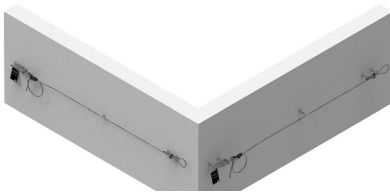

AIO-LIFELINE-SYSTEM-NON-PASSABLE-FACADE

All-in-one lifeline system, non-passable, for facade use

For details see subsequent pages

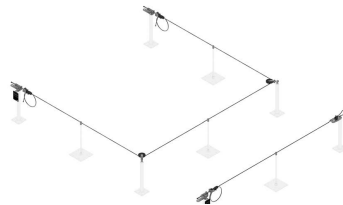

AIO-LIFELINE-SYSTEM-NON-PASSABLE

All-in-one lifeline system, non-passable

For details see subsequent pages



KIT-BOX-SYSTEM

All-in-one lifeline system, pre-assembled

For details see subsequent pages

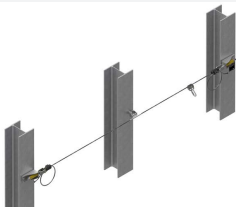

IND-LIFELINE-SYSTEM

All-in-one lifeline system for industrial use

For details see subsequent pages



VERT-LIFELINE SYSTEM

All-in-one lifeline system, vertical

For details see subsequent pages

AIO-LIFELINE-SYSTEM-PASSABLE

All-in-one lifeline system, passable

The AIO LIFELINE SYSTEM PASSABLE is used wherever a horizontal surface must be protected. Regardless whether along roofs, facades, in industry or for photovoltaic systems, it provides optimum protection against falls from a height. Neither complex buildings nor the substructure represent a problem for the lifeline system, because it can be optimally attached to a wide range of substructures. The modular system components ensure installation which is both simple and defect-free. The slider makes it possible to pass over intermediate brackets and curves, thus completely avoiding inconvenient attachment and detachment. Inclusion in building lightning protection on the roof (testing as per EN 62305) is possible.

BENEFITS

- Efficient installation through wide fastening distances up to 15 m.
- Long working life thanks to robust construction and easy visual checking of cable tension through the viewing window.
- Removable slider types optimally matched to the use case.
- Fall protection and the rope access method in just one system, thanks to the combination of selected posts and abseiling positions in the lifeline system.

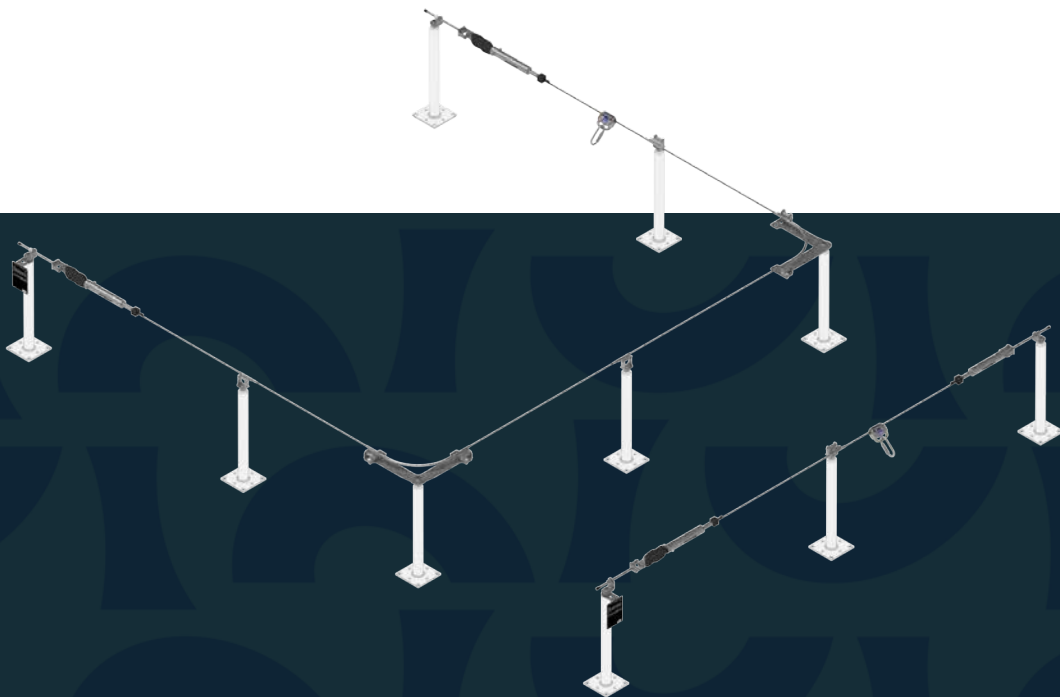

New fasteners for Aerocompact, Novotegra and K2 now available.

Technical product description

The system's principle component is our stable and proven 8 mm stainless steel cable. The cable, together with the various individual components, such as the passable intermediate brackets and curve elements, the end lock, and the slider for different uses matched to the system, combine to create an integrated, harmonised system. The lifeline system can be attached to a large number of substructures.



TECHNICAL BENEFITS

Reduction of installation effort

Depending on the substructure, the fastening distance can be up to 15 m. From a financial point of view, the wide fastening distances have a positive effect on the overall installation process.

Simple checking of readiness for use

The easily visible cable fastening allows a precise assessment of the cable clamping, and thus a simple inspection of the lifeline system's readiness for use (end lock with viewing window).

Consistent cable tension

The adjustable constant cable pre-tensioner is located at the end of the lifeline system. Amongst other things it ensures consistent cable tension in the event of temperature deviations.

State of the art certification:

EN 795:2012 TYP C und E

CEN/TS 16415

Components

AIO-TYP-20

Rating plate TYP-20 for lifeline systems

Material: stainless steel (AISI 316), plastic for identifying a horizontal lifeline system
Various fastening options!



AIO-TYP-21

Rating plate TYP-21 for lifeline systems

Material: stainless steel (AISI 316), plastic for identifying a self-supporting horizontal lifeline system
Various fastening options!



AIO-TYP-20-DIBt

Rating plate TYP-20-DIBt for lifeline systems

Material: stainless steel (AISI 316), plastic for identifying a horizontal lifeline system according to DIBt guidelines
Various fastening options!



SOPV-K2-TYP-AIO

Rating plate for AIO on K2 SYSTEMS

New

Dimensions: 82x 150 mm
Material: stainless steel (AISI 316), plastic for identifying a horizontal cable system on K2 SYSTEMS



SOPV-NOVO-TYP-AIO

Rating plate for AIO on NOVOTEGRA flat roof 2 base rail

New

Dimensions: 82x 150 mm
Material: stainless steel (AISI 316), plastic for identifying a horizontal cable system on NOVOTEGRA flat roof 2 base rail



SOPV-AERO-TYP-AIO

Rating plate for AIO on AEROCOMPACT

New

Dimensions: 82x 150 mm
Material: stainless steel (AISI 316), plastic for identifying a horizontal cable system on AEROCOMPACT



AIO-ENDS-10

End lock set ENDS-10 for lifeline systems

Material: stainless steel (AISI 304), aluminium (anodised)
Complete set for one cable span, constant spring pre-tension and indicator clamp!



AIO-SEIL-30

Stainless steel cable SEIL-30 for lifeline system

Dimensions: Ø 8 mm (7 x 7)
Breaking load: 37 kN
Material: stainless steel (AISI 316)
tested for INNOTECH lifeline systems



AIO-EB-10

End lock fastening EB-10 for lifeline systems

Mountable on: AIO-STA, AIO-STX, AIO-FALZ, AIO-SAND, AIO-VARIO, AIO-SYST, etc.
Connection: thread M16
Material: stainless steel (AISI 304)
for fastening the lifeline system with an end lock (AIO-ENDS-10)



AIO-EB-15

End lock fastening EB-15 for lifeline systems

Mountable on: AIO-STA, AIO-FALZ, AIO-SAND, AIO-VARIO, AIO-SYST, etc.
Connection: thread M16
Material: stainless steel (AISI 304)
for fastening the lifeline system with an end lock (AIO-ENDS-10)



AIO-SZH-10

Intermediate bracket SZH-10 for lifeline systems

Mountable on: STA, FALZ, SAND, VARIO, SYST, etc.
Connection: thread M16
Function range: 220°
Material: stainless steel (AISI 304)
For use on both sides without detaching the slider!



AIO-EDLE-50

Curve EDLE-50 for lifeline systems

Mountable on: STA, FALZ, SAND, VARIO, SYST, etc.
Pass-over capability: inside or outside corners and overhead systems
Connection: thread M16
Material: stainless steel (AISI 304)
for setting up a 90° corner set
Variably adjustable cable angle thanks to bent base plate!



Components

AIO-EDLE-50-ROHRBOGEN

Pipe bend EDLE-50 for lifeline systems

Application: AIO-EDLE-50
Material: stainless steel (AISI 304)
 for setting up a 80°, 105° or 120° corner set
Pass-over capability: only outside!



AIO-EDLE-50-O

Outside curve EDLE-50 for lifeline systems

Mountable on: STA, FALZ, SAND, VARIO, SYST, etc.
Pass-over capability: outside corner formation
Connection: thread M16
Material: stainless steel (AISI 304)
 for setting up a 90° corner set
 Variably adjustable cable angle thanks to bent base plate!



AIO-EDLE-50-I

Inside curve EDLE-50 for lifeline systems

Mountable on: STA, FALZ, SAND, VARIO, SYST, etc.
Pass-over capability: inside corner formation
Connection: thread M16
Material: stainless steel (AISI 304)
 for setting up a 90° corner set
 Variably adjustable cable angle thanks to bent base plate!



AIO-EDLE-11

Corner pass-through element EDLE-11 for lifeline

Mountable on: AIO-STA, AIO-STX, AIO-FALZ, AIO-SAND, AIO-VARIO, AIO-SYST, etc. **Pass-over capability:** inside corners **Connection:** thread M16 **Material:** stainless steel (AISI 304)
 for setting up a 135° corner set



AIO-EDLE-16

Extension tube EDLE-16 for lifeline systems

Pass-over capability: special corners
Length: 1000 / 1500 / 3000 mm
Curve corner: 0°
Material: stainless steel (AISI 316)
 Suitable bending device or flaring tool required for connecting to AIO-EDLE-12/ -13/ -17/ -18!



AIO-EDLE-16-90

Extension tube EDLE-16 for lifeline systems

Pass-over capability: special corners
Length: 1000 mm
Curve corner: 90°
Material: stainless steel (AISI 316)
 Suitable bending device or flaring tool required for connecting to AIO-EDLE-12/ -13/ -17/ -18!



AIO-EDLE-17

Corner pass-through element EDLE-17 for lifeline

Mountable on: AIO-STA, AIO-STX, AIO-FALZ, AIO-SAND, AIO-VARIO, AIO-SYST, etc.
Pass-over capability: inside or outside corners and overhead systems
Connection: thread M16
Engagement positions: 0°, 45°, 90°, 135°, 180°
Material: stainless steel (AISI 304)
 Only for usage with 2 pcs. of AIO-EDLE-16 and AIO-EDLE-18!



AIO-EDLE-18

Corner pass-through element EDLE-18 for lifeline

Mountable on: AIO-STA, AIO-STX, AIO-FALZ, AIO-SAND, AIO-VARIO, AIO-SYST, etc.
Pass-over capability: inside or outside corners and overhead systems
Connection: thread M16
Engagement positions: 0°, 45°, 90°, 135°, 180°
Material: stainless steel (AISI 304)
 Only for usage with 1 pce. of AIO-EDLE-16!



AIO-EDLE-19

Corner pass-through element EDLE-19 for lifeline

Mountable on: AIO-STA, AIO-STX, AIO-FALZ, AIO-SAND, AIO-VARIO, AIO-SYST, etc.
Pass-over capability: inside or outside corners and overhead systems
Connection: thread M16
Engagement positions: 0° / 45° / 90° / 135° / 180°
Material: stainless steel (AISI 304) **Angular displacement possible from 0° / 180° up to 135°!**
Suitable bending device or flaring tool required!



Accessory items

AIO-GLEIT-10-A4

Slider GLEIT-10 for lifeline systems

Material: stainless steel (AISI 316)
can be attached and detached at any point on the cable in the horizontal lifeline system
free to move over all pass-through elements (intermediate cable brackets and curves)



AIO-GLEIT-13-A4

Slider GLEIT-13 for lifeline systems

Material: stainless steel (AISI 316)
free to move over all pass-through elements (intermediate cable brackets and curves)



AIO-GLEIT-20-A4

Slider GLEIT-20 for lifeline systems

Material: stainless steel (AISI 316)
can be attached and detached at any point on the cable in the horizontal lifeline system
free to move over all pass-through elements (intermediate cable brackets and curves)



SHOCK-10

Shock absorber SHOCK-10 for lifeline systems

Material: aluminium anodised
reduces the forces in the end points of an AIO lifeline system
Enhancement of the cable deflection up to approximately 50 cm!



SHOCK-11

Shock absorber SHOCK-11 for lifeline systems

Material: stainless steel (AISI 316)
reduces the forces in the end points of an AIO lifeline system
Enhancement of the cable deflection up to approximately 1000 mm!



STA-10

Unipost STA-10 for all systems

Mountable on: concrete, wood, trapezoidal supporting sheet, steel construction, etc.
Post heights: 300/400/500/600 mm, Ø 48 mm
Base plate dimensions: 150 x 150 x 8 mm
Material: galvanised steel, stainless steel (AISI 316)



STA-12

Unipost STA-12 for all systems

Mountable on: concrete, hollow concrete slab, trapezoidal supporting sheet, steel construction, etc.
Post height: 400 / 600 / 800 mm, Ø 48 mm
Base plate dimensions: 300 x 300 x 8 mm
Material: galvanised steel



STA-16

End and corner post STA-16 for all systems

Mountable on: concrete (anchoring depth at least 100 mm), steel construction, etc.
Post height: 200 / 500 mm, Ø 48 mm
Base plate dimensions: 150 x 192 x 8 mm
Material: galvanised steel
(use 4 pcs. of adhesive anchor bolts M12)
Special lengths upon request!



QUAD-11

Unipost QUAD-11

Mountable on: concrete, hollow core concrete, wood, trapezoidal supporting sheet
Post heights: 300/400/500/600 mm, Ø 16 mm
Base plate dimensions: 235 x 235 x 4 mm
Material: stainless steel (AISI 304)



QUAD-13

Unipost QUAD-13

Mountable on: concrete, trapezoidal sheet
Post heights: 300/400/500/600 mm, Ø 16 mm
Base plate dimensions: 212 x 212 x 5 mm
Packaging unit: 1 piece / 10 pieces
Material: coated steel (RAL 7004), stainless steel (AISI 304)



EAP-QUAD-13-END

End/corner point QUAD-13-END

Substructure: Concrete, trapezoidal supporting sheet
Post dimensions: 400/600 mm, Ø 16 mm
Base plate size: 212 x 212 x 5 mm
Material: coated steel (RAL 7004), stainless steel V2A (AISI 304), aluminium



VARIO-45

Universalpoint VARIO-45 for all systems

Mountable on: flat roofs up to 5° with parapet
Dimensions: 1536 x 1536 mm
Weight: approx. 21 kg (total weight 43 kg, packaging included)
Final weight: c. 384 - 499 kg
Can be filled with: concrete or 12/15 pcs. of concrete slabs (50 x 50 x 5 cm, 49 x 49 x 5 cm) or 16/20 pcs. of concrete slabs (50 x 50 x 3,8 cm)
Material: stainless steel (AISI 304)
Without roof perforation!

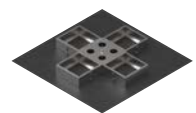

Accessory items

EUE-101-STA-10

Set items STA-10 incl. BEF-104-A4

Substructure: Concrete
Post dimensions: 400/600/800 mm, Ø 48 mm
Base plate size: 150 x 150 x 8 mm
Material: galvanised steel, stainless steel V2A (AISI 304)



ZST-101-QUAD-11

Set items QUAD -11 incl. BEF-104-A4

Substructure: Concrete
Post dimensions: 400/600 mm, Ø 16 mm
Base plate size: 235 x 235 x 4 mm
Material: stainless steel V2A (AISI 304)



EUE-102-STA-12

Set items STA-12 incl. BEF-107

Substructure: Hollow slab
Post dimensions: 400/600/800 mm, Ø 48 mm
Base plate size: 300 x 300 x 8 mm
Material: galvanised steel



ZST-102-QUAD-11

Set items QUAD-11 incl. BEF-103

Substructure: Concrete, hollow concrete slab
Post dimensions: 400/600 mm, Ø 16 mm
Base plate size: 235 x 235 x 4 mm
Material: stainless steel V2A (AISI 304)



EUE-201-STA-10

Set items STA-10 incl. BEF-201

Substructure: Wood
Post dimensions: 400/600/800 mm, Ø 48 mm
Base plate size: 150 x 150 x 8 mm
Material: galvanised steel, stainless steel V4A (AISI 316)



ZST-201-QUAD-11

Set items QUAD-11 incl. BEF-209-A2

Substructure: Solid wood ceiling
Post dimensions: 400/600 mm, Ø 16 mm
Base plate size: 235 x 235 x 4 mm
Material: stainless steel V2A (AISI 304)



ZST-201-STA-10

Set items STA-10 incl. BEF-201

Substructure: Wooden rafters (min. 16 x 16cm)
Post dimensions: 400/600 mm, Ø 48 mm
Base plate size: 150 x 150 x 8 mm
Material: galvanised steel, stainless steel V4A (AISI 316)



EUE-202-1-STA-12

Set items STA-12 incl. BEF-210-A2

Substructure: OSB
Post dimensions: 400/600/800 mm, Ø 48 mm
Base plate size: 300 x 300 x 8 mm
Material: galvanised steel



ZST-202-1-QUAD-11

Set items QUAD-11 incl. BEF-307

Substructure: Wood lightweight roof, OSB
Post dimensions: 400/600 mm, Ø 16 mm
Base plate size: 235 x 235 x 4 mm
Material: stainless steel V2A (AISI 304)

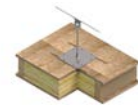

EUE-203-STA-12

Set items STA-12 incl. BEF-210-A2

Substructure: Wood - rough formwork
Post dimensions: 400/600/800 mm, Ø 48 mm
Base plate size: 300 x 300 x 8 mm
Material: galvanised steel



ZST-203-QUAD-11

Set items QUAD-11 incl. BEF-208

Substructure: Wood - rough formwork
Post dimensions: 400/600 mm, Ø 16 mm
Base plate size: 235 x 235 x 4 mm
Material: stainless steel V2A (AISI 304)



EUE-301-STA-12

Set items STA-12 incl. BEF-307 and BEF-307-1

Substructure: Trapezoidal supporting sheet
Post dimensions: 400/600/800 mm, Ø 48 mm
Base plate size: 300 x 300 x 8 mm
Material: galvanised steel



Accessory items

ZST-301-QUAD-11

Set items QUAD-11 incl. BEF-307

Substructure: Trapezoidal supporting sheet
Post dimensions: 400/600 mm, Ø 16 mm
Base plate size: 235 x 235 x 4 mm
Material: stainless steel V2A (AISI 304)



SOPV-K2-AIO-SET-10

New

Fastening set for end lock set on K2 SYSTEMS BasicRail

Length: 1995 mm
Material: aluminum, stainless steel
 For module widths of 1448-1779mm.



SOPV-K2-AIO-SET-11

New

Fastening set for end lock set on K2 SYSTEMS BasicRail

Length: 2365mm
Material: aluminum, stainless steel
 For module widths of 1780-2050m



SOPV-K2-AIO-SET-20

New

Fastening set for cable intermediate bracket on K2 SYSTEMS BasicRail

Material: aluminum, stainless steel



SOPV-K2-AIO-SET-30

New

Fastening set for EDLE / SZH / EAP on K2 SYSTEMS BasicRail

Length: 1995 mm
Material: aluminum, stainless steel
 For module widths of 1448-1779mm.



SOPV-K2-AIO-SET-31

New

Fastening set for EDLE / SZH / EAP on K2 SYSTEMS BasicRail

Length: 2365 mm
Material: aluminum, stainless steel
 For module widths of 1780-2050 mm.



SOPV-K2-AIO-SET-40

New

Extension set on K2 SYSTEMS BasicRail

Length: 1995 mm
Material: aluminum, stainless steel
 Extension set for:
 SOPV-K2-AIO-SET-10
 SOPV-K2-AIO-SET-11
 SOPV-K2-AIO-SET-30
 SOPV-K2-AIO-SET-31
 SOPV-K2-TAURUS-SET-10
 SOPV-K2-TAURUS-SET-11
 SOPV-K2-TAURUS-SET-30
 SOPV-K2-TAURUS-SET-31



SOPV-NOVO-AIO-SET-10

New

Fastening set for end lock set on NOVOTEGRA flat roof 2 base rail

Material: aluminum, stainless steel



SOPV-NOVO-AIO-SET-20

New

Fastening set for cable intermediate bracket on NOVOTEGRA flat roof 2 base rail

Material: aluminum, stainless steel



SOPV-AERO-AIO-SET-10

New

Fastening set for end lock set on AEROCOMPACT SN 2 / SN2+

Length: 1995 mm
Material: aluminum, stainless steel
 For module widths of 1448-1779mm.



SOPV-AERO-AIO-SET-11

New

Fastening set for end lock set on AEROCOMPACT SN 2 / SN2+

Length: 2365 mm
Material: aluminum, stainless steel
 For module widths of 1448-1779mm.



SOPV-AERO-AIO-SET-20

New

Fastening set for cable intermediate bracket on AEROCOMPACT SN 2 / SN2+

Material: aluminum, stainless steel



Accessory items

SOPV-AERO-AIO-SET-30 New

Fastening set for EDLE / SZH / EAP on AEROCOMPACT SN 2 / SN2+

Length: 1995 mm
Material: aluminum, stainless steel
 For module widths of 1448-1779mm.



SOPV-AERO-AIO-SET-31 New

Fastening set for EDLE / SZH / EAP on AEROCOMPACT SN 2 / SN2+

Length: 2365 mm
Material: aluminum, stainless steel
 For module widths of 1448-1779mm.



SOPV-AERO-AIO-SET-40 New

Extension for base rail on AEROCOMPACT SN 2 / SN2+

Length: 1755 mm
Material: aluminum, stainless steel



SOPV-AERO-AIO-SET-41 New

Extension for base rail on AEROCOMPACT SN 2 / SN2+

Length: 2195 mm
Material: aluminum, stainless steel



SOPV-AERO-VB-SET-10 New

Connector for sliding base on AEROCOMPACT SN 2 / SN2+

Material: aluminum, stainless steel



SAND-01-A2

Universal point SAND-01-A2

Substructure: Trapezoidal sheet
Material: Steel, aluminium
Material thickness: Steel min. 0.6 mm, aluminium min. 0.7 mm
Width profile: 250 to 414 mm
Base plate size: 430 x 415 x 1.5 mm
Material: Stainless steel V2A (AISI 304)
 At the same time, order suitable fastening material (steel BEF-309/aluminium BEF-306).

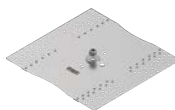

SAND-13-A2

Universal point SAND-13

Substructure: Trapezoidal sheet,
material: Steel
Material thickness: min. 0.5 mm
Width profile: 210 to 330 mm
Base plate size: 300 x 365 x 2 mm
Material: Stainless steel V2A (AISI 304)
 At the same time, order suitable fastening material (steel 0,5-3mm BEF-306 / steel 0,6-1,5mm BEF-310).
 Use as intermediate bracket, variable height adjustment up to 50 mm (VL-20-50), to increase the spacing between the lifeline system and the roof cladding.



FALZ-45

Universal point FALZ-45

Mountable on: Standing seam roofs
Material: aluminium, copper, titanium-zinc alloy, stainless steel, galvanised steel, etc.
Material thickness: min. 0.6 mm
Width of profile: 370 - 640 mm or 520 - 790 mm
 Without roof perforation!



FALZ-25

FALZ-25 intermediate point for lifeline systems

Mountable on: standing seam roofs
Material: aluminium, copper, titanium-zinc alloy, stainless steel, galvanised steel, etc.
Material thickness: min. 0.6 mm
Width of profile: 370 640 mm or 520 790 mm
Material: stainless steel (AISI 304)
 Without roof perforation!



Only for use as intermediate cable bracket in AIO lifeline system!

Variable height adjustment up to 50 mm (VL-20-50) to increase the spacing between the lifeline system and the roofing!

SYST-01

Universal point SYST-01

Mountable on: (Double-) standing seam roofs
Material (material thickness): steel (min. 0.5 mm), aluminium (min. 0.7 mm)
Width of profile: 410 - 610 mm
Material: aluminium, stainless steel (AISI 304)
 Pre-assembled and without roof perforation!
 Not suitable for copper roofs !



SYST-04

Universal point SYST-04

Mountable: system roofs similar to INTERFALZ
Material (material thickness): steel (min. 0.5 mm), aluminium (min. 0.7 mm)
Width of profile: 305 - 333 mm or 400 - 500 mm
Material: aluminium, stainless steel (AISI 304)
 Pre-assembled and without roof perforation!
 For Germany, a national technical approval (abZ for construction products in the scope of the federal state building codes) and a mark of compliance (compliance mark as per the Compliance Mark ordinance) are necessary for this product.



Accessory items

AIO-SYST-20

Universal point SYST-20

Mountable on: trapezoidal covering sheet

Material: steel, aluminium

Material thickness: min. 0.5 mm

Width of profile: 475 - 695 mm

Material: aluminium, stainless steel (AISI 304)



BIA-SET-02



AIO-LIFELINE-SYSTEM-PASSABLE-FACADE

All-in-one lifeline system, passable, for facade use

The AIO-PASSABLE-FACADE lifeline system is a fall protection system which is deployed on facades, walls, and parapets. The protection of complex facade structures presents no problem to the lifeline system. Thanks to the fasteners specially developed for the facade application, such as intermediate bracket, end lock fastening, corner pass-through element, and much more, there is no longer anything to prevent installation along a facade. The slider makes it possible to pass over intermediate brackets and curves, thus completely avoiding inconvenient attachment and detachment by the protected person.

BENEFITS

- Simple installation using the fasteners developed for the facade area.
- Efficient installation through wide fastening distances up to 7,5 m.
- Long working life thanks to robust construction and easy visual checking of cable tension through the viewing window.
- Removable slider types optimally matched to the use case.

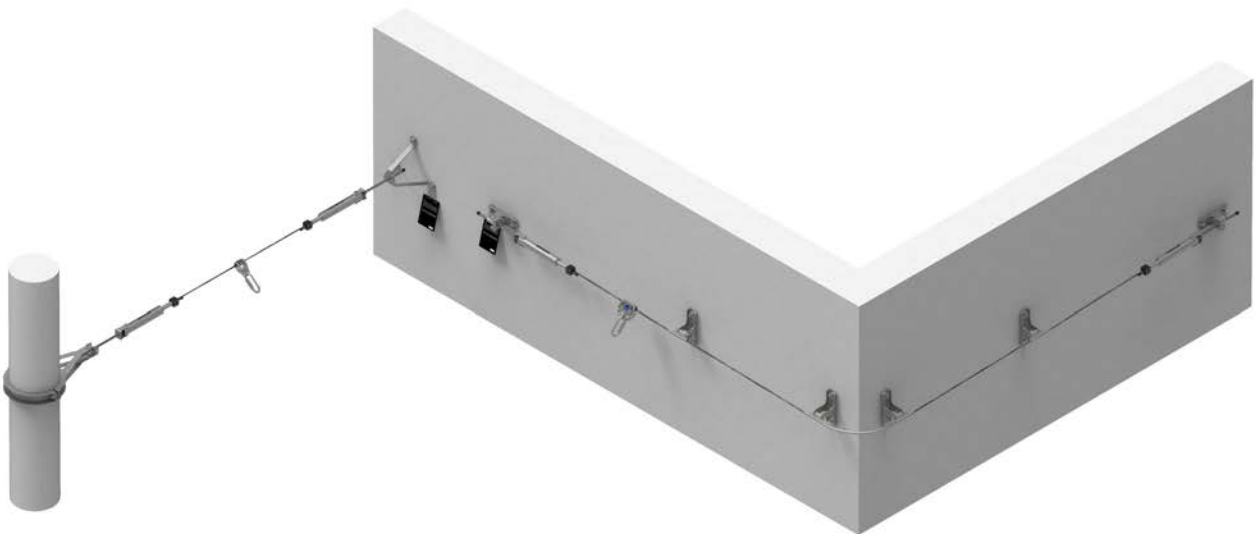

Currently no updates for this product

Technical product description

The system's principle component is our stable and proven 8 mm stainless steel cable. The cable, together with the various individual components, such as passable intermediate brackets and curve elements, the end lock, and a slider for different uses matched to the system, combine to create an integrated, harmonised system. The lifeline system can above all be attached to facades, walls, and parapets.



TECHNICAL BENEFITS

Reduction of installation effort

Depending on the substructure, the fastening distance can be up to 7,5 m. From a financial point of view, the wide fastening distances have a positive effect on the overall installation process.

Simple checking of readiness for use

The easily visible cable fastening allows a precise assessment of the cable clamping, and thus a simple inspection of the lifeline system's readiness for use (end lock with viewing window).

Consistent cable tension

The adjustable constant cable pre-tensioner is located at the end of the lifeline system. Amongst other things it ensures consistent cable tension in the event of temperature deviations.

State of the art certification:

EN 795:2012 TYP C und E

CEN/TS 16415

Components

AIO-TYP-20

Rating plate TYP-20 for lifeline systems

Material: stainless steel (AISI 316), plastic for identifying a horizontal lifeline system
Various fastening options!



AIO-ENDS-10

End lock set ENDS-10 for lifeline systems

Material: stainless steel (AISI 304), aluminium (anodised)
Complete set for one cable span, constant spring pre-tension and indicator clamp!



AIO-SEIL-30

Stainless steel cable SEIL-30 for lifeline system

Dimensions: Ø 8 mm (7 x 7)
Breaking load: 37 kN
Material: stainless steel (AISI 316) tested for INNOTECH lifeline systems



AIO-EB-11

End lock fastening EB-11 for façade

Mountable on: facade
Connection: fastening boreholes Ø 17 mm
Through boreholes: 134 mm
Material: stainless steel (AISI 304) for fastening the lifeline system with an end lock (AIO-ENDS-10)



AIO-EB-12

End lock fastening EB-12 for façade

Mountable on: concrete wall, facade
Connection: Ø 13 mm
Material: stainless steel (AISI 304) for fastening the lifeline system with an end lock (AIO-ENDS-10) 90° to the wall
Heavy duty anchors (BEF-104-A4) must not be used on weathered facades or insulation! (use 3 pcs. of adhesive anchorbilts M12)



AIO-SZH-11

Intermediate bracket SZH-11 for façade

Mountable on: facades
Connection: fastening boreholes Ø 17 mm
Through boreholes: 134 mm
Function range: 220°
Material: stainless steel (AISI 304)



AIO-SZH-90

Intermediate bracket SZH-90 for lifeline systems

Mountable on: wood
Connection: mounting hole Ø 12 mm
Material: stainless steel V2A (AISI 304)



AIO-EDLE-12

Curve EDLE-12 for façade lifeline systems

Mountable on: facade
Pass-over capability: inside or outside corners and overhead systems
Connection: fastening boreholes Ø 17 mm
Through boreholes: 134 mm
Engagement positions: 0°, 45°, 90°, 135°, 180°
Material: stainless steel (AISI 304) for setting up a 90° corner set



AIO-EDLE-13

Curve EDLE-13 for façade lifeline systems

Mountable on: steel construction
Pass-over capability: inside and outside corners or overhead systems
Connection: fastening boreholes Ø 17 mm
Engagement positions: 0°, 45°, 90°, 135°, 180°
Material: stainless steel (AISI 304) for setting up a 90° corner set
Restricted use as outside corners!



AIO-EDLE-16

Extension tube EDLE-16 for lifeline systems

Pass-over capability: special corners
Length: 1000 / 1500 / 3000 mm
Curve corner: 0°
Material: stainless steel (AISI 316)
Suitable bending device or flaring tool required for connecting to AIO-EDLE-12/ -13/ -17/ -18!



AIO-EDLE-16-90

Extension tube EDLE-16 for lifeline systems

Pass-over capability: special corners
Length: 1000 mm
Curve corner: 90°
Material: stainless steel (AISI 316)
Suitable bending device or flaring tool required for connecting to AIO-EDLE-12/ -13/ -17/ -18!



Accessory items

AIO-GLEIT-10-A4

Slider GLEIT-10 for lifeline systems

Material: stainless steel (AISI 316)
can be attached and detached at any point on the cable
in the horizontal lifeline system
free to move over all pass-through elements
(intermediate cable brackets and curves)



AIO-GLEIT-13-A4

Slider GLEIT-13 for lifeline systems

Material: stainless steel (AISI 316)
free to move over all pass-through elements
(intermediate cable brackets and curves)



AIO-GLEIT-20-A4

Slider GLEIT-20 for lifeline systems

Material: stainless steel (AISI 316)
can be attached and detached at any point on the cable
in the horizontal lifeline system
free to move over all pass-through elements
(intermediate cable brackets and curves)



SHOCK-10

Shock absorber SHOCK-10 for lifeline systems

Material: aluminium anodised
reduces the forces in the end points of an AIO lifeline
system
Enhancement of the cable deflection up to
approximately 50 cm!



SHOCK-11

Shock absorber SHOCK-11 for lifeline systems

Material: stainless steel (AISI 316)
reduces the forces in the end points of an AIO lifeline
system
Enhancement of the cable deflection up to
approximately 1000 mm!



AIO-PASSABLE-OVERHEAD-LIFELINE-SYSTEM

All-in-one lifeline system, passable, for overhead use

The AIO PASSABLE OVERHEAD LIFELINE SYSTEM is deployed wherever a horizontal overhead must be protected. Regardless whether along a maintenance walkway or in the area of machine safeguarding, the lifeline system can be relied upon to protect against falls. It also adapts to complex building and facade structures, and at the same time is suitable for fastening to a wide range of substructures. The modular system components enable simple and defect-free installation. The slider types, specially developed for overhead use, ensure optimum travel over curves and intermediate brackets overhead.

BENEFITS

- Efficient installation through wide fastening distances up to 7,5 m.
- Long working life thanks to robust construction and simplicity of visual checking of cable tension through the viewing window.
- System has optimum freerunning characteristics thanks to the slider types specially developed for overhead use.
- Additional safety thanks to compatibility with the appropriate fall arrest device.

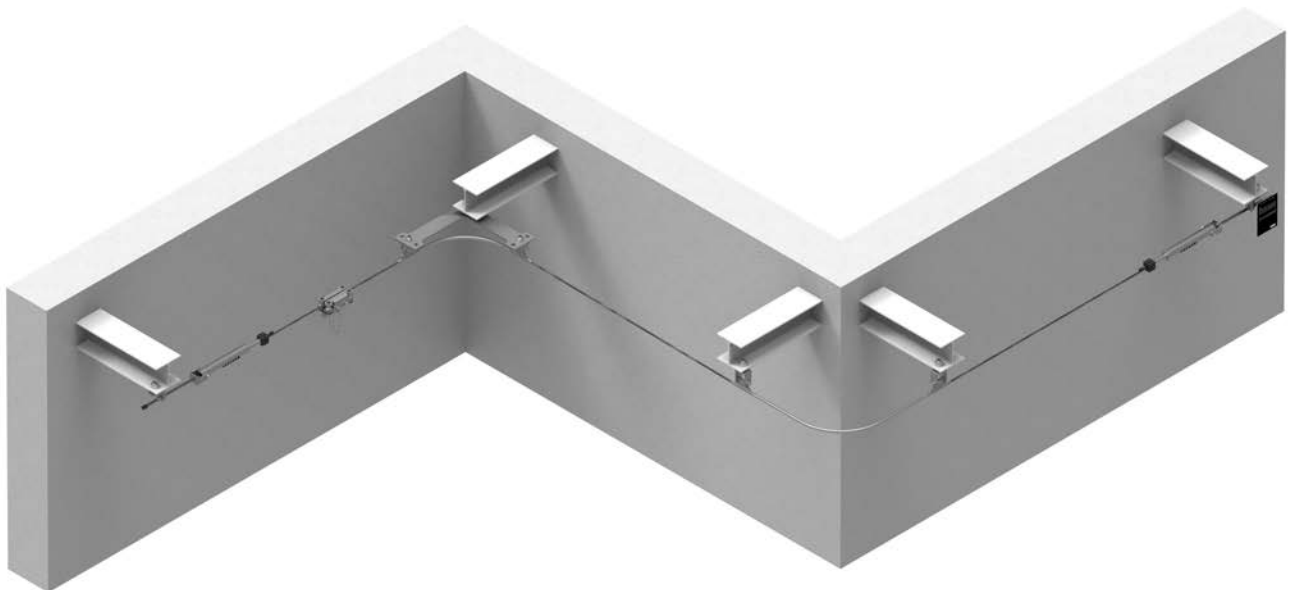

The new passable AIO-GLEIT-22 slider is available from the end of May. Not only does it combine the functions of the existing sliders (curve-compatible and suitable for straight runs), but it can also be mounted and removed at any position in the system. The optimised roller geometry ensures free-running movement in the system. It is delivered in a practical carrying bag.

Technical product description

The system's principle component is our stable and proven 8 mm stainless steel cable. The cable, together with the various individual components, such as passable intermediate brackets and curve elements, the end lock, and a slider matched to overhead use, combine to create an integrated, harmonised system. The lifeline system can be attached to a large number of substructures.



TECHNICAL BENEFITS

Reduction of installation effort

Depending on the substructure, the fastening distance can be up to 7.5 m. From a financial point of view, the wide fastening distances have a positive effect on the overall installation process.

Simple checking of readiness for use

The easily visible cable fastening allows a precise assessment of the cable clamping, and thus a simple inspection of the lifeline system's readiness for use (end lock with viewing window).

Consistent cable tension

The adjustable constant cable pre-tensioner is located at the end of the lifeline system. Amongst other things it ensures consistent cable tension in the event of temperature deviations.

State of the art certification:

EN 795 TYP C und E

CEN/TS 16415

Components

AIO-TYP-20

Rating plate TYP-20 for lifeline systems

Material: stainless steel (AISI 316), plastic for identifying a horizontal lifeline system
Various fastening options!



AIO-TYP-20-DIBt

Rating plate TYP-20-DIBt for lifeline systems

Material: stainless steel (AISI 316), plastic for identifying a horizontal lifeline system according to DIBt guidelines
Various fastening options!



AIO-ENDS-10

End lock set ENDS-10 for lifeline systems

Material: stainless steel (AISI 304), aluminium (anodised)
Complete set for one cable span, constant spring pre-tension and indicator clamp!



AIO-SEIL-30

Stainless steel cable SEIL-30 for lifeline system

Dimensions: Ø 8 mm (7 x 7)
Breaking load: 37 kN
Material: stainless steel (AISI 316) tested for INNOTECH lifeline systems



AIO-EB-10

End lock fastening EB-10 for lifeline systems

Mountable on: AIO-STA, AIO-STX, AIO-FALZ, AIO-SAND, AIO-VARIO, AIO-SYST, etc.
Connection: thread M16
Material: stainless steel (AISI 304) for fastening the lifeline system with an end lock (AIO-ENDS-10)



AIO-EB-15

End lock fastening EB-15 for lifeline systems

Mountable on: AIO-STA, AIO-FALZ, AIO-SAND, AIO-VARIO, AIO-SYST, etc.
Connection: thread M16
Material: stainless steel (AISI 304) for fastening the lifeline system with an end lock (AIO-ENDS-10)



AIO-EB-12

End lock fastening EB-12 for façade

Mountable on: concrete wall, façade
Connection: Ø 13 mm
Material: stainless steel (AISI 304) for fastening the lifeline system with an end lock (AIO-ENDS-10) 90° to the wall
Heavy duty anchors (BEF-104-A4) must not be used on weathered facades or insulation! (use 3 pcs. of adhesive anchorbolts M12)



AIO-SZH-10

Intermediate bracket SZH-10 for lifeline systems

Mountable on: STA, FALZ, SAND, VARIO, SYST, etc.
Connection: thread M16
Function range: 220°
Material: stainless steel (AISI 304)
For use on both sides without detaching the slider!



AIO-SZH-90

Intermediate bracket SZH-90 for lifeline systems

Mountable on: wood
Connection: mounting hole Ø 12 mm
Material: stainless steel V2A (AISI 304)



AIO-EDLE-50

Curve EDLE-50 for lifeline systems

Mountable on: STA, FALZ, SAND, VARIO, SYST, etc.
Pass-over capability: inside or outside corners and overhead systems
Connection: thread M16
Material: stainless steel (AISI 304) for setting up a 90° corner set
Variably adjustable cable angle thanks to bent base plate!



AIO-EDLE-11

Corner pass-through element EDLE-11 for lifeline

Mountable on: AIO-STA, AIO-STX, AIO-FALZ, AIO-SAND, AIO-VARIO, AIO-SYST, etc. **Pass-over capability:** inside corners **Connection:** thread M16 **Material:** stainless steel (AISI 304) for setting up a 135° corner set



AIO-EDLE-16

Extension tube EDLE-16 for lifeline systems

Pass-over capability: special corners
Length: 1000 / 1500 / 3000 mm
Curve corner: 0°
Material: stainless steel (AISI 316)
Suitable bending device or flaring tool required for connecting to AIO-EDLE-12/ -13/ -17/ -18!



Components

AIO-EDLE-16-90

Extension tube EDLE-16 for lifeline systems

Pass-over capability: special corners

Length: 1000 mm

Curve corner: 90°

Material: stainless steel (AISI 316)

Suitable bending device or flaring tool required for connecting to AIO-EDLE-12/ -13/ -17/ -18!



AIO-EDLE-17

Corner pass-through element EDLE-17 for lifeline

Mountable on: AIO-STA, AIO-STX, AIO-FALZ, AIO-SAND, AIO-VARIO, AIO-SYST, etc.

Pass-over capability: inside or outside corners and overhead systems

Connection: thread M16

Engagement positions: 0°, 45°, 90°, 135°, 180°

Material: stainless steel (AISI 304)

Only for usage with 2 pcs. of AIO-EDLE-16 and AIO-EDLE-18!



AIO-EDLE-18

Corner pass-through element EDLE-18 for lifeline

Mountable on: AIO-STA, AIO-STX, AIO-FALZ, AIO-SAND, AIO-VARIO, AIO-SYST, etc.

Pass-over capability: inside or outside corners and overhead systems

Connection: thread M16

Engagement positions: 0°, 45°, 90°, 135°, 180°

Material: stainless steel (AISI 304)

Only for usage with 1 pce. of AIO-EDLE-16!



AIO-EDLE-19

Corner pass-through element EDLE-19 for lifeline

Mountable on: AIO-STA, AIO-STX, AIO-FALZ, AIO-SAND, AIO-VARIO, AIO-SYST, etc.

Pass-over capability: inside or outside corners and overhead systems

Connection: thread M16

Engagement positions: 0° / 45° / 90° / 135° / 180°

Material: stainless steel (AISI 304) **Angular displacement possible from 0° / 180° up to 135°!**

Suitable bending device or flaring tool required!



Accessory items

AIO-GLEIT-22

New

All-In-One slider detachable curve compatible overhead lifeline systems

Material: aluminium, stainless steel V2A (AISI 304), stainless steel V4A (AISI 304)



AIO-LIFELINE-SYSTEM-NON-PASSABLE-FACADE

All-in-one lifeline system, non-passable, for facade use

The AIO LIFELINE SYSTEM NON-PASSABLE, FACADE is a fall protection system which is used along facades, walls, and parapets. The protection of complex facade structures represents no problem for the system. The system components, specially developed for use on facades, ensure simple and defect-free installation on a wide range of substructures. Because this is a non-passable lifeline system, it consists of individual components which require the person using the system to attach and detach.

BENEFITS

- Simple installation using the fasteners developed for the facade area.
- Efficient installation through wide fastening distances up to 7,5 m.
- Long working life thanks to robust construction and easy visual checking of cable tension through the viewing window.
- Simple system without sliders. However, a Y-lanyard is required for the use and safety of the person using the system.

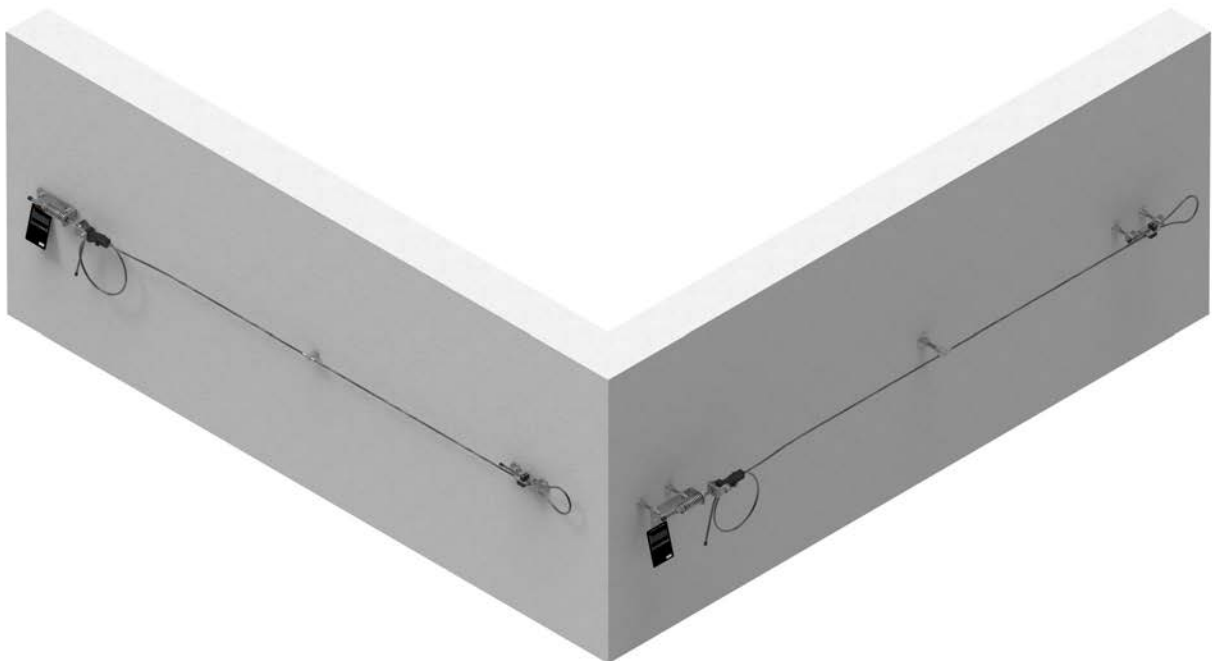

Currently no updates for this product

Technical product description

The system's principle component is our stable and proven 8 mm stainless steel cable. The cable, together with the various individual components, such as the non-passable intermediate brackets and curve elements, and the end lifeline system, a Y-lanyard is required. This connects the person using the harness to the lifeline system.



TECHNICAL BENEFITS

Reduction of installation effort

Depending on the substructure, the fastening distance can be up to 7,5 m. From a financial point of view, the wide fastening distances have a positive effect on the overall installation process.

Simple checking of readiness for use

The easily visible cable fastening allows a precise assessment of the cable clamping, and thus a simple inspection of the lifeline system's readiness for use (end lock with viewing window).

State of the art certification:

EN 795TYP C und E

CEN/TS 16415

Components

Rating plate TYP-50 for lifeline systems

Material: stainless steel V4A (AISI 316), plastic for identifying a horizontal lifeline system in combination with the end lock AIO-ENDS-50/51
Various fastening options!



AIO-ENDS-50

End lock ENDS-50 A2 for lifeline systems

Material: stainless steel (AISI 304), aluminium (anodised)

This end lock is for a non passable cable span with integrated shock force absorption!

For a cable span with a corner set, a second AIO-ENDS-50 is required, for a straight cable span an AIO-ENDS-51 is required!



AIO-ENDS-51-A2

End lock ENDS-51 A2 for lifeline systems

Material: stainless steel (AISI 304), aluminium (anodised)

This end lock is for a non-passable cable span with integrated shock force absorption!

To be used only in combination with AIO-ENDS-50, for a straight cable span!



AIO-SEIL-30

Stainless steel cable SEIL-30 for lifeline system

Dimensions: \varnothing 8 mm (7 x 7)

Breaking load: 37 kN

Material: stainless steel (AISI 316)
tested for INNOTECH lifeline systems



AIO-SZH-13

Intermediate bracket SZH-13 for lifeline systems

Mountable on: STA, BKS, SAND, VARIO, SYST, QUAD, etc.

Connection: thread M16

Material: stainless steel V2A (AISI 304)
Not passable with the slider.



H10006667

Y-lanyard PSA-EQUIP-17

Material: PA-tubular tape

Length: 2 m

strong Y-lanyard as fall protection system



AIO-LIFELINE-SYSTEM NON-PASSABLE

All-in-one lifeline system, non-passable

The AIO LIFELINE SYSTEM NON-PASSABLE i is used wherever a horizontal surface must be protected. Regardless whether along roofs, facades, or in industry, it provides optimum protection against falls. Not only does it adapt to complex building structures, it can also be attached optimally to a wide range of substructures. The modular, flexible system components ensure easy, defect-free installation. Because the lifeline system consists of non-passable individual components, attachment and detachment to/from the system is necessary.

BENEFITS

- Efficient installation through wide fastening distances up to 15 m.
- Easy and above all fast installation thanks to the end lock with integrated energy absorber.
- Simple system without sliders. However, a Y-lanyard is required for the use and safety of the person using the system.
- Fall protection and the rope access method in just one system, thanks to the option to combine selected posts with abseiling positions.

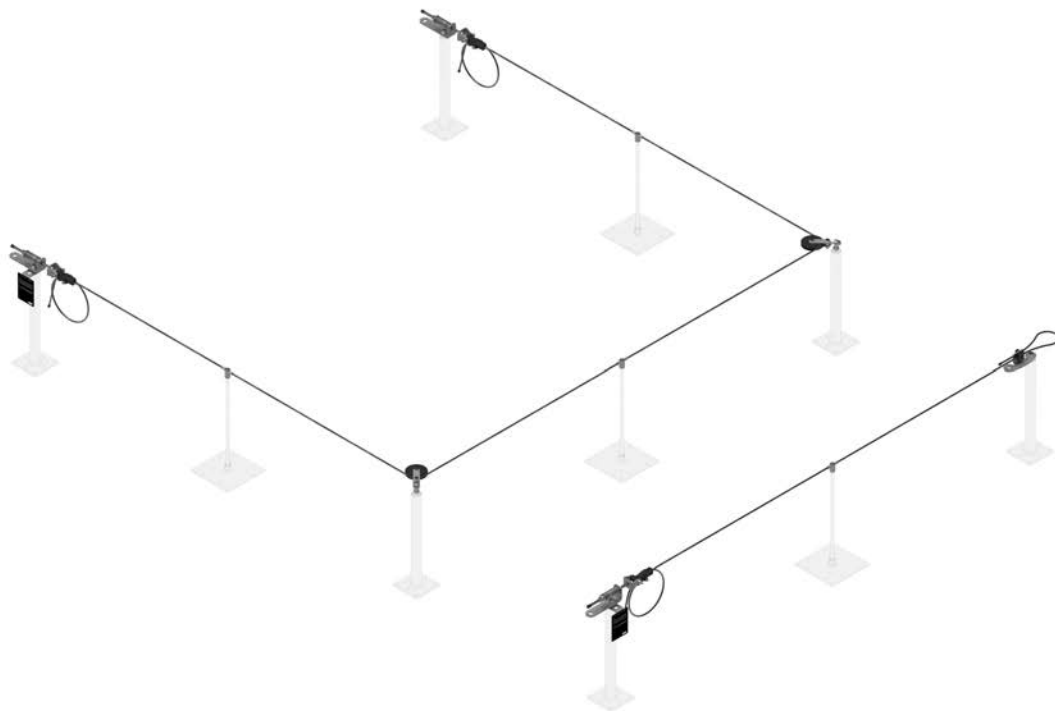

Currently no updates for this product

Technical product description

The system's principle component is our stable and proven 8 mm stainless steel cable. The cable, together with the various individual components, such as the non-passable intermediate brackets and curve elements, and the end lock with integrated shock force absorption, combine to create a harmonised system. For secured movement in the lifeline system, a Y-lanyard is required. This connects the person using the harness to the lifeline system.



TECHNICAL BENEFITS

Reduction of installation effort

Depending on the substructure, the fastening distance can be up to 15 m. From a financial point of view, the wide fastening distances have a positive effect on the overall installation process.

Simple checking of readiness for use

The easily visible cable fastening allows a precise assessment of the cable clamping, and thus a simple inspection of the lifeline system's readiness for use (end lock with viewing window).

Variable corner formation

For the AIO LIFELINE SYSTEM, NON PASSABLE, the AIO-EDLE-15 curve element allows a variable, non-passable corner formation, based on the angle.

State of the art certification:

EN 795 TYP C und E

CEN/TS 16415

Components and associated equipment

Components

Rating plate TYP-50 for lifeline systems

Material: stainless steel V4A (AISI 316), plastic for identifying a horizontal lifeline system in combination with the end lock AIO-ENDS-50/51
Various fastening options!



AIO-TYP-51

Rating plate TYP-51 for lifeline systems

Material: stainless steel (AISI 316), plastic for identifying a self-supporting horizontal lifeline system in combination with the end lock AIO-ENDS-50/51
Various fastening options!



AIO-ENDS-50

End lock ENDS-50 A2 for lifeline systems

Material: stainless steel (AISI 304), aluminium (anodised)
This end lock is for a non passable cable span with integrated shock force absorption!
For a cable span with a corner set, a second AIO-ENDS-50 is required, for a straight cable span an AIO-ENDS-51 is required!



AIO-ENDS-51-A2

End lock ENDS-51 A2 for lifeline systems

Material: stainless steel (AISI 304), aluminium (anodised)
This end lock is for a non-passable cable span with integrated shock force absorption!
To be used only in combination with AIO-ENDS-50, for a straight cable span!



AIO-SEIL-30

Stainless steel cable SEIL-30 for lifeline system

Dimensions: \varnothing 8 mm (7 x 7)
Breaking load: 37 kN
Material: stainless steel (AISI 316)
tested for INNOTECH lifeline systems



AIO-SZH-13

Intermediate bracket SZH-13 for lifeline systems

Mountable on: STA, BKS, SAND, VARIO, SYST, QUAD, etc.
Connection: thread M16
Material: stainless steel V2A (AISI 304)
Not passable with the slider.



AIO-EDLE-14

Curve EDLE-14 for lifeline system

Mountable on: AIO-STA, AIO-STX, AIO-FALZ, AIO-SAND, AIO-VARIO, AIO-SYST, etc.
Pass-over capability: inside corners
Connection: thread M16
Material: stainless steel (AISI 304), plastic for setting up a variable corner set



AIO-EDLE-15

Curve EDLE-15 for lifeline system

Mountable on: AIO-STA, AIO-FALZ, AIO-SAND, AIO-VARIO, AIO-SYST, etc.
Application: inside corners
Connection: thread M16
Material: stainless steel (AISI 304), plastic for setting up a variable corner set



H10006667

Y-lanyard PSA-EQUIP-17

Material: PA-tubular tape
Length: 2 m
strong Y-lanyard as fall protection system



Accessory items

STA-10

Unipost STA-10 for all systems

Mountable on: concrete, wood, trapezoidal supporting sheet, steel construction, etc.

Post heights: 300/400/500/600 mm, Ø 48 mm

Base plate dimensions: 150 x 150 x 8 mm

Material: galvanised steel, stainless steel (AISI 316)



STA-12

Unipost STA-12 for all systems

Mountable on: concrete, hollow concrete slab, trapezoidal supporting sheet, steel construction, etc.

Post height: 400 / 600 / 800 mm, Ø 48 mm

Base plate dimensions: 300 x 300 x 8 mm

Material: galvanised steel



STA-16

End and corner post STA-16 for all systems

Mountable on: concrete (anchoring depth at least 100 mm), steel construction, etc.

Post height: 200 / 500 mm, Ø 48 mm

Base plate dimensions: 150 x 192 x 8 mm

Material: galvanised steel

(use 4 pcs. of adhesive anchor bolts M12)

Special lengths upon request!



QUAD-11

Unipost QUAD-11

Mountable on: concrete, hollow core concrete, wood, trapezoidal supporting sheet

Post heights: 300/400/500/600 mm, Ø 16 mm

Base plate dimensions: 235 x 235 x 4 mm

Material: stainless steel (AISI 304)



QUAD-13

Unipost QUAD-13

Mountable on: concrete, trapezoidal sheet

Post heights: 300/400/500/600 mm, Ø 16 mm

Base plate dimensions: 212 x 212 x 5 mm

Packaging unit: 1 piece / 10 pieces

Material: coated steel (RAL 7004), stainless steel (AISI 304)



EAP-QUAD-13-END

End/corner point QUAD-13-END

Substructure: Concrete, trapezoidal supporting sheet

Post dimensions: 400/600 mm, Ø 16 mm

Base plate size: 212 x 212 x 5 mm

Material: coated steel (RAL 7004), stainless steel V2A (AISI 304), aluminium



VARIO-45

Universalpoint VARIO-45 for all systems

Mountable on: flat roofs up to 5° with parapet

Dimensions: 1536 x 1536 mm

Weight: approx. 21 kg (total weight 43 kg, packaging included)

Final weight: c. 384 - 499 kg

Can be filled with: concrete or 12/15 pcs. of concrete slabs (50 x 50 x 5 cm, 49 x 49 x 5 cm)

or 16/20 pcs. of concrete slabs (50 x 50 x 3,8 cm)

Material: stainless steel (AISI 304)

Without roof perforation!

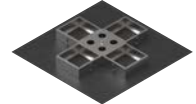

EUE-101-STA-10

Set items STA-10 incl. BEF-104-A4

Substructure: Concrete

Post dimensions: 400/600/800 mm, Ø 48 mm

Base plate size: 150 x 150 x 8 mm

Material: galvanised steel, stainless steel V2A (AISI 304)



ZST-101-QUAD-11

Set items QUAD -11 incl. BEF-104-A4

Substructure: Concrete

Post dimensions: 400/600 mm, Ø 16 mm

Base plate size: 235 x 235 x 4 mm

Material: stainless steel V2A (AISI 304)



EUE-102-STA-12

Set items STA-12 incl. BEF-107

Substructure: Hollow slab

Post dimensions: 400/600/800 mm, Ø 48 mm

Base plate size: 300 x 300 x 8 mm

Material: galvanised steel



ZST-102-QUAD-11

Set items QUAD-11 incl. BEF-103

Substructure: Concrete, hollow concrete slab

Post dimensions: 400/600 mm, Ø 16 mm

Base plate size: 235 x 235 x 4 mm

Material: stainless steel V2A (AISI 304)



EUE-201-STA-10

Set items STA-10 incl. BEF-201

Substructure: Wood

Post dimensions: 400/600/800 mm, Ø 48 mm

Base plate size: 150 x 150 x 8 mm

Material: galvanised steel, stainless steel V4A (AISI 316)



Accessory items

ZST-201-QUAD-11

Set items QUAD-11 incl. BEF-209-A2

Substructure: Solid wood ceiling
Post dimensions: 400/600 mm, Ø 16 mm
Base plate size: 235 x 235 x 4 mm
Material: stainless steel V2A (AISI 304)



ZST-201-STA-10

Set items STA-10 incl. BEF-201

Substructure: Wooden rafters (min. 16 x 16cm)
Post dimensions: 400/600 mm, Ø 48 mm
Base plate size: 150 x 150 x 8 mm
Material: galvanised steel, stainless steel V4A (AISI 316)



EUE-202-1-STA-12

Set items STA-12 incl. BEF-210-A2

Substructure: OSB
Post dimensions: 400/600/800 mm, Ø 48 mm
Base plate size: 300 x 300 x 8 mm
Material: galvanised steel



ZST-202-1-QUAD-11

Set items QUAD-11 incl. BEF-307

Substructure: Wood lightweight roof, OSB
Post dimensions: 400/600 mm, Ø 16 mm
Base plate size: 235 x 235 x 4 mm
Material: stainless steel V2A (AISI 304)



EUE-203-STA-12

Set items STA-12 incl. BEF-210-A2

Substructure: Wood - rough formwork
Post dimensions: 400/600/800 mm, Ø 48 mm
Base plate size: 300 x 300 x 8 mm
Material: galvanised steel



ZST-203-QUAD-11

Set items QUAD-11 incl. BEF-208

Substructure: Wood - rough formwork
Post dimensions: 400/600 mm, Ø 16 mm
Base plate size: 235 x 235 x 4 mm
Material: stainless steel V2A (AISI 304)



EUE-301-STA-12

Set items STA-12 incl. BEF-307 and BEF-307-1

Substructure: Trapezoidal supporting sheet
Post dimensions: 400/600/800 mm, Ø 48 mm
Base plate size: 300 x 300 x 8 mm
Material: galvanised steel

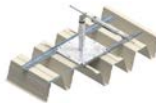

ZST-301-QUAD-11

Set items QUAD-11 incl. BEF-307

Substructure: Trapezoidal supporting sheet
Post dimensions: 400/600 mm, Ø 16 mm
Base plate size: 235 x 235 x 4 mm
Material: stainless steel V2A (AISI 304)



SAND-01-A2

Universal point SAND-01-A2

Substructure: Trapezoidal sheet
Material: Steel, aluminium
Material thickness: Steel min. 0.6 mm, aluminium min. 0.7 mm
Width profile: 250 to 414 mm
Base plate size: 430 x 415 x 1.5 mm
Material: Stainless steel V2A (AISI 304)
 At the same time, order suitable fastening material (steel BEF-309/aluminium BEF-306).



SAND-13-A2

Universal point SAND-13

Substructure: Trapezoidal sheet,
material: Steel
Material thickness: min. 0.5 mm
Width profile: 210 to 330 mm
Base plate size: 300 x 365 x 2 mm
Material: Stainless steel V2A (AISI 304)
 At the same time, order suitable fastening material (steel 0,5-3mm BEF-306 / steel 0,6-1,5mm BEF-310).
 Use as intermediate bracket, variable height adjustment up to 50 mm (VL-20-50), to increase the spacing between the lifeline system and the roof cladding.



FALZ-45

Universal point FALZ-45

Mountable on: Standing seam roofs
Material: aluminium, copper, titanium-zinc alloy, stainless steel, galvanised steel, etc.
Material thickness: min. 0.6 mm
Width of profile: 370 - 640 mm or 520 - 790 mm
 Without roof perforation!



FALZ-25

FALZ-25 intermediate point for lifeline systems

Mountable on: standing seam roofs
Material: aluminium, copper, titanium-zinc alloy, stainless steel, galvanised steel, etc.
Material thickness: min. 0.6 mm
Width of profile: 370 640 mm or 520 790 mm
Material: stainless steel (AISI 304)
 Without roof perforation!
 Only for use as intermediate cable bracket in AIO lifeline system!
 Variable height adjustment up to 50 mm (VL-20-50) to increase the spacing between the lifeline system and the roofing!



Accessory items

SYST-01

Universal point SYST-01

Mountable on: (Double-) standing seam roofs
Material (material thickness): steel (min. 0.5 mm),
aluminium (min. 0.7 mm)
Width of profile: 410 - 610 mm
Material: aluminium, stainless steel (AISI 304)
Pre-assembled and without roof perforation!
Not suitable for copper roofs !



SYST-04

Universal point SYST-04

Mountable: system roofs similar to INTERFALZ
Material (material thickness): steel (min. 0.5 mm),
aluminium (min. 0.7 mm)
Width of profile: 305 - 333 mm or 400 - 500 mm
Material: aluminium, stainless steel (AISI 304)
Pre-assembled and without roof perforation!
For Germany, a national technical approval (abZ for
construction products in the scope of the federal state
building
codes) and a mark of compliance (compliance mark as
per the Compliance Mark ordinance) are necessary for
this
product.



AIO-SYST-20

Universal point SYST-20

Mountable on: trapezoidal covering sheet
Material: steel, aluminium
Material thickness: min. 0.5 mm
Width of profile: 475 - 695 mm
Material: aluminium, stainless steel (AISI 304)



KIT-BOX-SYSTEM

All-in-one lifeline system, pre-assembled

The KIT BOX SYSTEM is ideally suited for construction sites and building projects. It can be used wherever it is necessary to protect horizontal movement. It is a non-passable system with a maximum total system length of 30 m. It provides reliable fall protection, regardless whether along roofs, in industry, on facades, for building projects, or as a permanent solution. The pre-assembled system is delivered in handy packaging, and merely requires attachment to the respective substructure. This ensures rapid, simple, and flexible installation.

BENEFITS

- User-friendliness and time-saving, thanks to the pre-assembled horizontal lifeline system.
- Easy transport of all system-relevant components, thanks to the practical packaging.
- Reduction of forces on the endpoints in the event of a fall, thanks to the special shock absorber and constant cable pre-tension.
- Simple and flexible installation with no training requirement.



Available in two system lengths!



Technical product description

The system's principle component is our stable and proven 8 mm stainless steel cable. The cable, together with the various individual components, such as the non-passable intermediate elements and the end lock with integrated shock force absorption, combine to create a harmonised system. For secured movement in the lifeline system, a Y-lanyard is required. This connects the person using the harness to the lifeline.



TECHNICAL BENEFITS

Reduction of installation effort

Depending on the substructure, the separation of the fastenings can be up to 15 m (maximum total system length 30 m). From a financial point of view, the wide fastening distances have a positive effect on the overall installation process.

Simple checking of readiness for use

The easily visible cable fastening allows a precise assessment of the cable clamping, and thus a simple inspection of the lifeline system's readiness for use (end lock with viewing window).

Reduction of forces in the event of a fall

In the event of a fall, the special shock absorber and the constant cable pre-tension reduce the forces arising on the endpoints of the lifeline system.

State of the art certification:

EN 795 TYP C

Components

KIT-BOX

Pre-assembled horizontal lifeline system KIT-BOX

Length: 15 / 30 m

Material: stainless steel (AISI 304), aluminium (anodised), plastic

complete kit:

1 end lock

1 rating plate

cable of stainless steel

Quick assembly system - all components of the cable system are partly pre-assembled and summarized in a bucket!

KIT-BOX-30 incl. 1 LIFELINE-KIT-SZH-10 (intermediate bracket)!



LIFELINE-KIT-SZH-10

Intermediate cable bracket, horizontal lifeline

Mountable on: AIO-STA, AIO-STX, AIO-FALZ, AIO-SAND, AIO-VARIO, AIO-SYST, etc.

Connection: thread M16

Material: stainless steel (AISI 304)

Suitable for installation on posts can only be passed over with steel carabiner!



IND-LIFELINE-SYSTEM

All-in-one lifeline system for industrial use

The IND LIFELINE SYSTEM was specially developed for use in industry, and it can be used wherever a straight horizontal run up to an inclination of 10 % has to be protected. It can be attached temporarily or permanently to various steel constructions. To be able to cover the greater separation distances required for industrial applications, it is equipped with a particularly robust cable. High cable preload and the compression of the intermediate bracket make reduced cable deflection possible, and therefore provide ideal protection for tasks at height in industry.

BENEFITS

- Broad range of applications focussed on industrial use, because it can be used attached either temporarily or permanently.
- Robust system, thanks to a cable diameter of 10 mm for increased cable pre-tension and minimum cable sag.
- Financially attractive thanks to max. separation distances of 7,5 m (temporary) or 15/30 m (permanent).
- Low cable deflection in the event of a fall, thanks to high cable pre-tension.

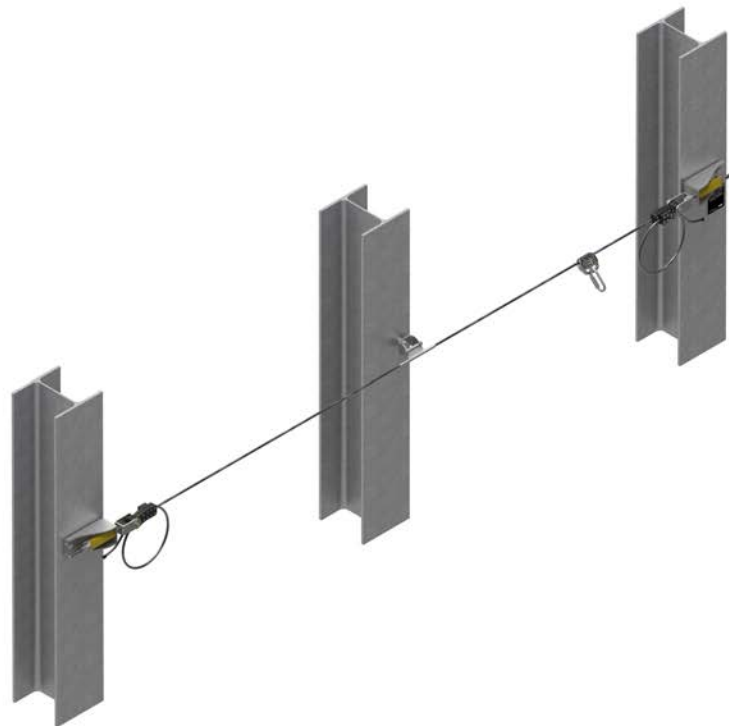

Currently no updates for this product

Technical product description

The system's principle component is our enormously stable 10 mm stainless steel cable. The cable, together with the various individual components, such as passable intermediate brackets and curve elements, the end lock with integrated shock force absorption, and the slider matched to the system, combine to create an integrated, harmonised system. The lifeline system can be attached to various steel constructions.



TECHNICAL BENEFITS

Reduction of installation effort

Depending on the overall system length, the separation of the fastenings can be up to 30 m. From a financial point of view, the wide fastening distances have a positive effect on the overall installation process.

Simple checking of readiness for use

The easily visible cable fastening allows a precise assessment of the cable clamping, and thus a simple inspection of the lifeline system's readiness for use (end lock with viewing window).

Consistent cable tension

Despite a cable length of 30 m, the 10 mm cable and the adjustable constant cable pre-tensioner located at the end of the lifeline system ensure consistent cable tension in the event of fluctuating temperatures. This means that there is almost no cable sag.

State of the art certification:

EN 795 TYP B / TYP C

CEN/TS 16415

Components

IND-TYP-20

Rating plate TYP-20 for Industry lifeline system

Material: stainless steel V4A (AISI 316), plastic for identifying a horizontal lifeline system



IND-ENDS-10

End lock set ENDS-10 for Industry lifeline system

Material: stainless steel V2A (AISI 304), aluminium (anodised)
Complete set for one cable span, constant spring pre-tension



IND-SEIL-40

Stainless steel cable SEIL-40 for lifeline system

Dimensions: Ø 10 mm (7 x 19)

Breaking load: 57 kN

Material: stainless steel V4A (AISI 316) tested for INNOTECH lifeline systems



IND-EB-10

End lock fastening IND-EB-10 for lifeline system



IND-EB-20

End lock fastening IND-EB-20 for lifeline system



IND-EB-30

End lock fastening IND-EB-30 for lifeline system



IND-EB-40

End lock fastening EB-40 for lifeline systems

Mountable on: steel construction

Connection: thread M16

Material: stainless steel V2A (AISI 304) for fastening the lifeline system (Ø 10mm) with an end lock (IND-ENDS-10)



IND-SZH-10

Intermediate bracket SZH-10 for lifeline system

Mountable on: steel construction

Connection: thread M16

Function range: adjustment range variable

Material: stainless steel V2A (AISI 304)



Accessory items

IND-GLEIT-10-A4

Slider GLEIT-10 for Industry lifeline systems

Material: stainless steel V4A (AISI 316)
can be attached and detached at any point on the cable
in the horizontal lifeline system
free to move over all pass-through elements
(intermediate cable brackets and curves)



VERT-LIFELINE SYSTEM

All-in-one lifeline system, vertical

The VERT LIFELINE SYSTEM is used wherever vertical ascents or descents require protection. Regardless whether ladder access, shelving/mast systems (with or without ladder) or steel constructions with access systems, it provides continuous fall protection. With the correct slider, deviations of up to 15° from the vertical can be protected easily. It also provides unimpeded sliding along the passable system. To keep fall strain to a minimum, our VERT LIFELINE SYSTEM is equipped with the most up-to-date preload elements and shock absorbers. The two different attachment options significantly simplify the system's installation, either using a rail which serves as the base support for attachment to ladders, or by direct attachment to the building substructure using a fastening set.

BENEFITS

- Simple attachment of the system by means of clamping to ladders or steel structures.
- Increased safety in the event of a fall, thanks to consistent cable pre-tensioning.
- Prevention of incorrect use, thanks to the vertical slider with safety function (up & down).
- Economical solution, because no safety cage is required, thanks to the use of the VERT-LIFELINE-SYSTEM.

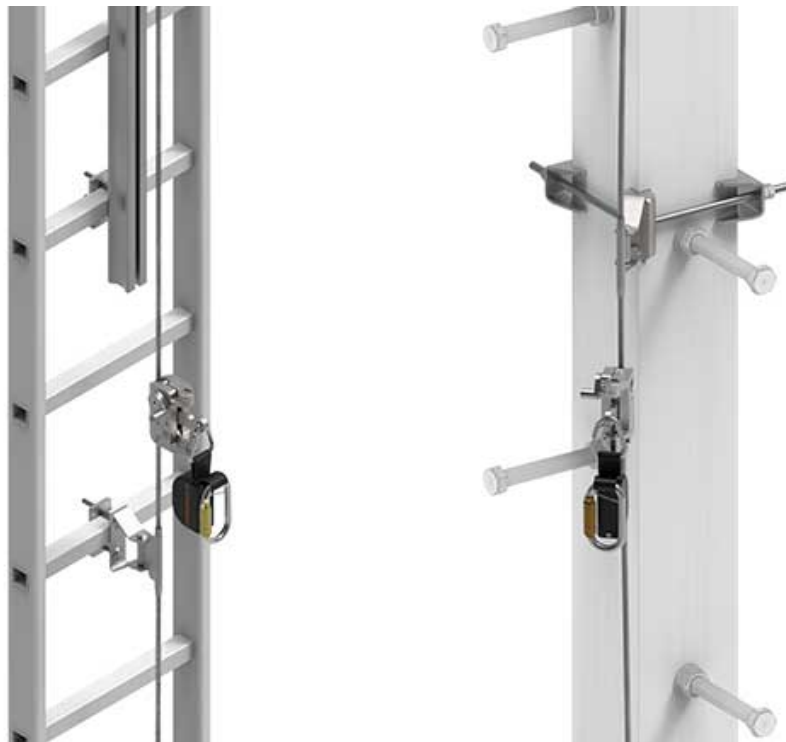

Currently no updates for this product



Technical product description

The system's principle component is our stable and proven 8 mm stainless steel cable. The cable, together with the various individual components, such as the passable intermediate brackets and curve elements, the end lock, and the slider matched to the system, with safety function (up & down), combine to create an integrated, harmonised system. For installation on ladders, there is the option of further protecting the exit area upwards, by means of an extension with an additional rail.



TECHNICAL BENEFITS

Reduction of installation effort

The maximum separation of the fastenings along a ladder and for installation on steel constructions is 5 metres. From a financial point of view, the wide fastening distances have a positive effect on the overall installation process.

Simple checking of readiness for use

The easily visible cable fastening allows a precise assessment of the cable clamping, and thus a simple inspection of the lifeline system's readiness for use (end lock with viewing window).

Reduction of fall force

The VERT-GLEIT-50 has an integrated energy absorber and reduces the force acting on the user to 6 kN max.

State of the art certification:

EN 353-1

EN 365

ANSI/ASSE Z359.16-2016

Components

VERT-TYP-50

Rating plate VERT-TYP-50, vertical lifeline syst

Dimensions: 3 x 12 cm

Material: plastic

For sticking on VERT-SET-50!



VERT-SET-50

Vertical lifeline system VERT-SET-50

Mountable on: ladders **Rung dimensions:** max. 45 x 45 mm, Ø 45 mm **Material:** stainless steel (AISI 304), aluminium

Additional safety fixation on the structure of the building (VERT-SAFE-50) optionally available!



VERT-SZH-50

Intermediate bracket SZH-50 for vertical systems

Mountable on: ladders

Rung dimensions: max. 45 x 55 mm, Ø 45 mm

Material: stainless steel (AISI 304)

Distance between intermediate bracket 5 m!



VERT-TYP-80

Rating plate VERT-TYP-80, vertical lifeline syst

Dimensions: 3.5 x 12.5 mm

Material: Stainless steel A4



VERT-SET-80

Vertical lifeline system VERT-SET-80

Substructure: L-corner constructions

Flange width: 60 - 250 mm

Flange thickness: 6 - 25 mm

Material: Stainless steel V2A (AISI 304), aluminium
Must be used only in combination with BEF-850-01/-02/-03.



VERT-SZH-80

Intermediate cable bracket SZH-80

Substructure: BEF-850-01/-02/-03

Material: Stainless steel V2A (AISI 304)

Must be used only in combination with BEF-850-01/-02/-03!

Intermediate bracket separation 5 m!



VERT-GLEIT-50

Slider GLEIT-50 for vertical lifeline systems

Material: stainless steel (AISI 304), (AISI 316)
can be quickly attached or detached at any point of the lifeline system,
with integrated fall shock absorber
for passing over the intermediate bracket (VERT-SZH-50)



Accessory items

VERT-SAFE-50

Redundant protection SAFE-50

Mountable on: structure

Material: aluminium

Additional protection to fasten VERT-SET-50 on the structure of the building!



Fastening set BEF-850-01

New

Material: Stainless steel V2A (AISI 304)

Flange width: 60 to 120 m

ust be used only in combination with BEF-851/-852/-853.

Available only upon request.



Fastening set BEF-850-02

New

Material: Stainless steel V2A (AISI 304)

Flange width: 120 to 180 m

ust be used only in combination with BEF-851/-852/-853.

Available only upon request.



Fastening set BEF-850-02

New

Material: Stainless steel V2A (AISI 304)

Flange width: 180 to 250 m

ust be used only in combination with BEF-851/-852/-853.

Available only upon request.



Fastening set BEF-851

New

Material: Stainless steel V2A (AISI 304)

Flange thickness: 6 to 12 m m

ust be used only in combination with BEF-850-01/-02/-03.

Available only upon request.



Fastening set BEF-852

New

Material: Stainless steel V2A (AISI 304)

Flange thickness: 12 to 18 m

ust be used only in combination with BEF-850-01/-02/-03.

Available only upon request.



Fastening set BEF-853

New

Material: Stainless steel V2A (AISI 304)

Flange thickness: 8 to 25 m

ust be used only in combination with BEF-850-01/-02/-03.

Available only upon request.





Head office
INNOTECH® Arbeitsschutz GmbH

Laizing 10
A 4656 Kirchham
T +43 7619 22 1 22 - 0
office@innotech.at
www.innotech.at

Branch Office Switzerland
INNOTECH® Arbeitsschutz GmbH

Seestraße 14b
CH 5432 Neuenhof
T +41 56 41 69 040
office@innotechag.ch
www.innotechag.ch

Branch Germany
INNOTECH® Arbeitsschutz GmbH

In der Steinwiese 5
D 57074 Siegen
T +49 271 23 41 94 - 0
office@innotech.de
www.innotech.de