

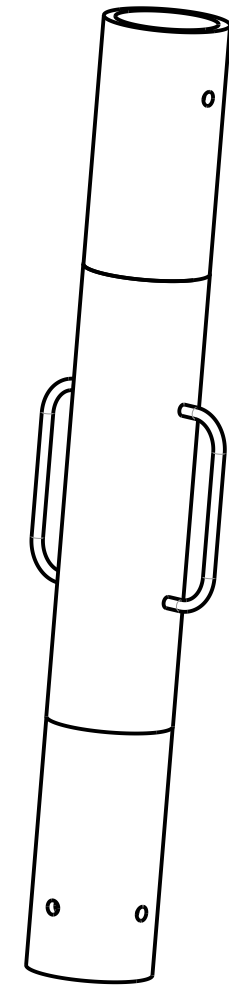

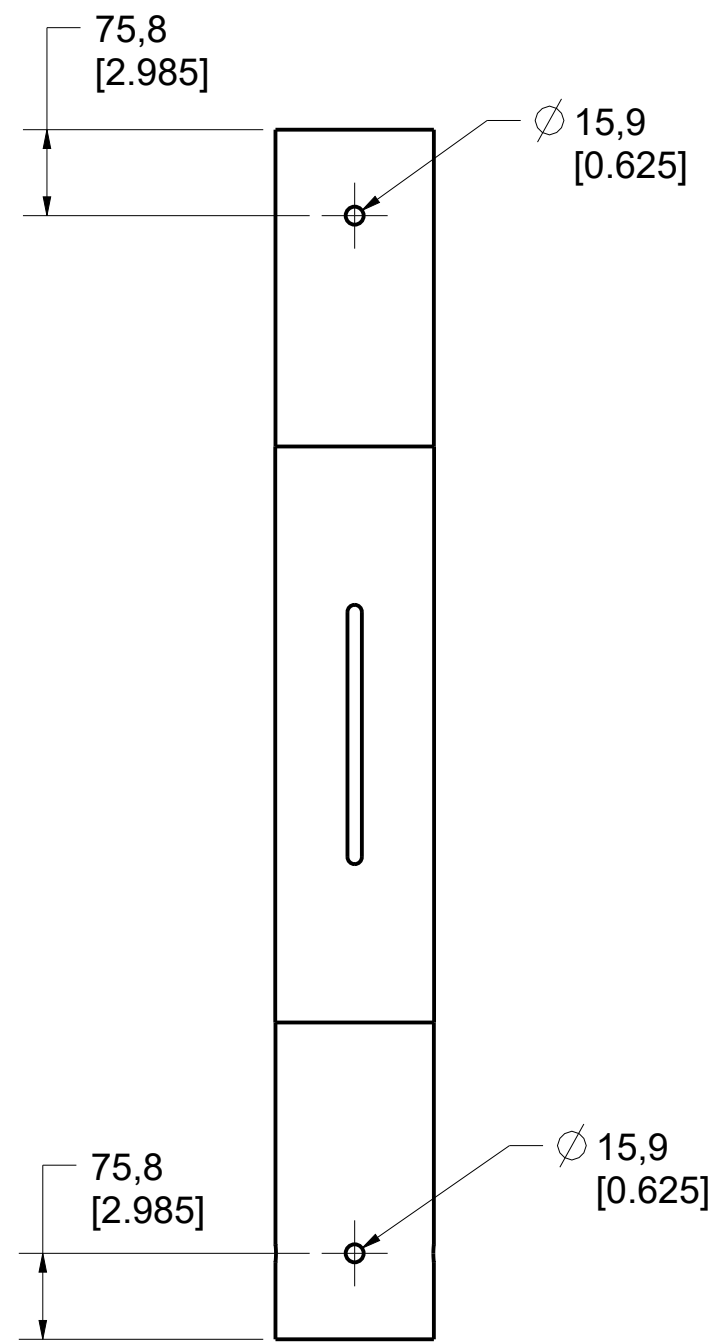

Product number: IN-2199

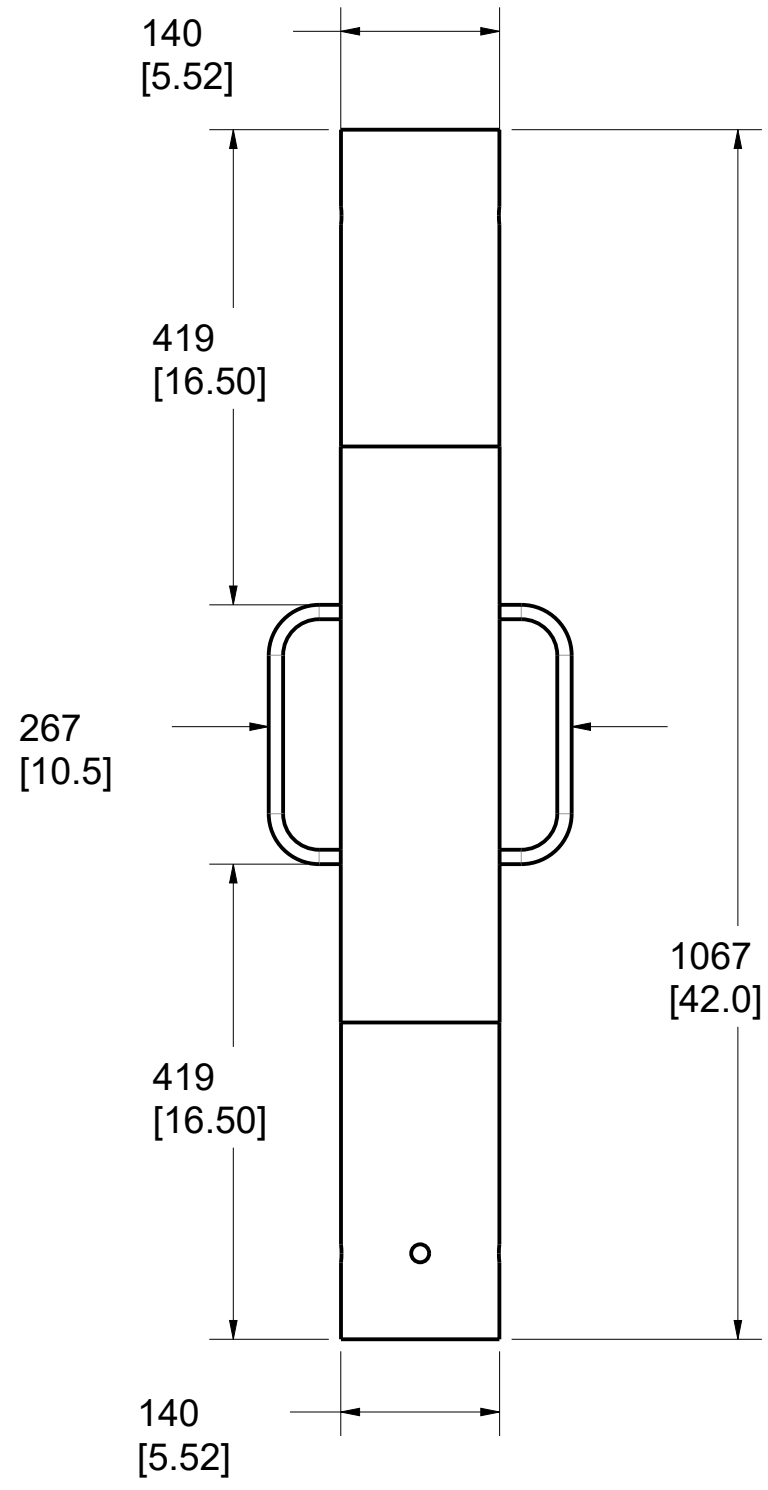
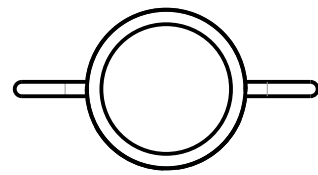

PAT.NO.:				
<b>PRODUITS DE SERVICE PUBLICS INNOVA INC.</b> <b>INNOVA PUBLIC UTILITY PRODUCTS INC.</b>				
© 9105-0732 QUEBEC INC. and under exclusive license to INNOVA PUBLIC UTILITY PRODUCTS INC., (hereafter « INNOVA »). All rights reserved. Protected under the Copyright Act of Canada and international treaties and agreements regarding copyrights. Violators are subject to prosecution and other legal recourses for infringement. Any reproduction, adaptation or other use or disclosure whatsoever, in totality or in part, and in any form or by any means whatsoever, strictly forbidden and requires the prior written approval of INNOVA. All data is the exclusive property of 9105-0732 QUEBEC INC. and under exclusive license to INNOVA and cannot be used nor disclosed in any way either without the prior written approval of INNOVA.				
WEIGHT:	TITLE:			
34 Lb	140mm (5.5") Mast			
15 Kg	for extendable Davit-Arm IN-2197			
COLOR:	Material:	SHEET(S):	PROJET:	Rev.
Safety Yellow	Aluminum	1 / 3	IN-2199	01

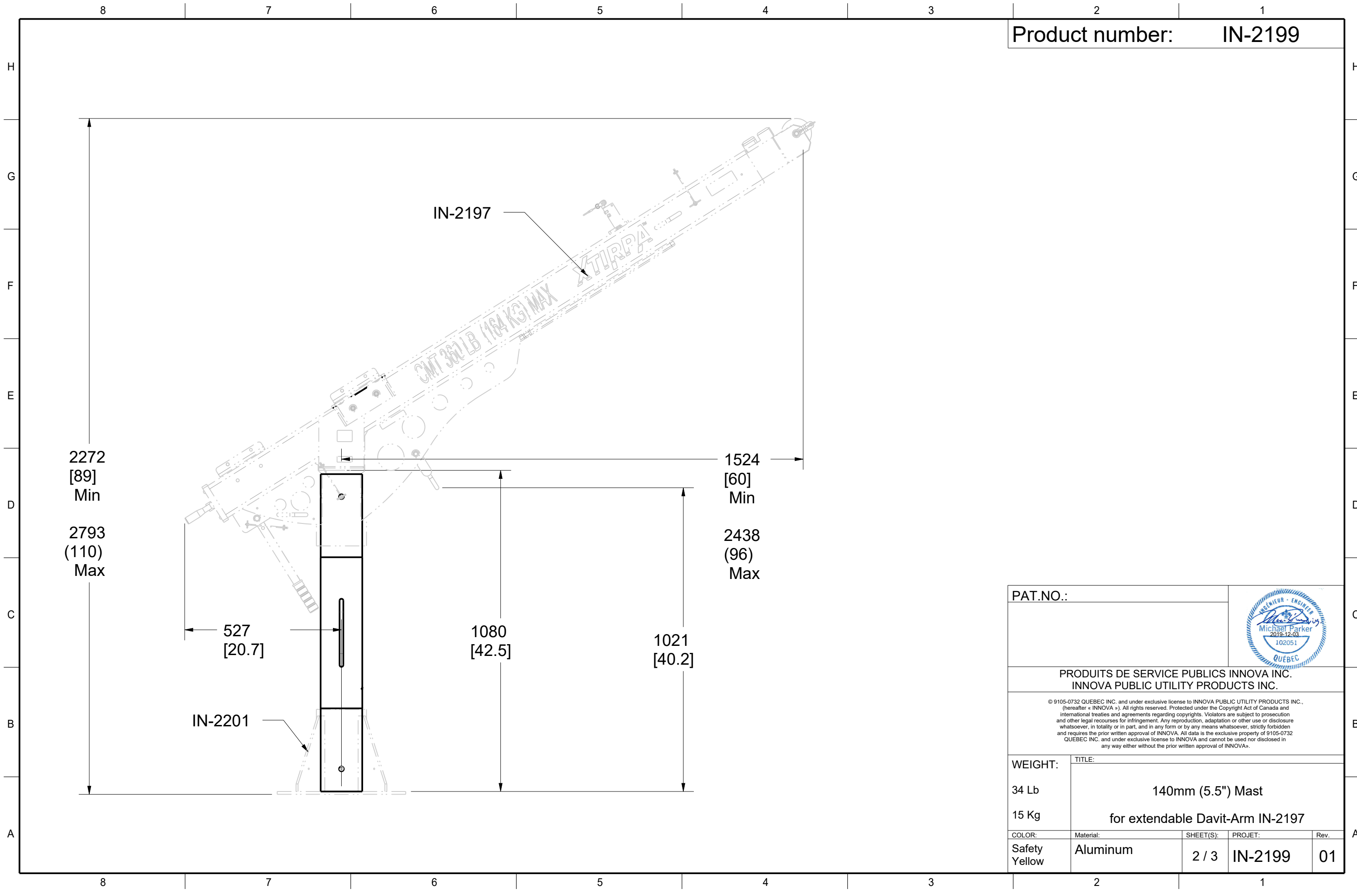
Product number: IN-2199



PAT.NO.:				
PRODUITS DE SERVICE PUBLICS INNOVA INC. INNOVA PUBLIC UTILITY PRODUCTS INC.				
<small>© 9105-0732 QUEBEC INC. and under exclusive license to INNOVA PUBLIC UTILITY PRODUCTS INC., (hereafter « INNOVA »). All rights reserved. Protected under the Copyright Act of Canada and international treaties and agreements regarding copyrights. Violators are subject to prosecution and other legal recourses for infringement. Any reproduction, adaptation or other use or disclosure whatsoever, in totality or in part, and in any form or by any means whatsoever, strictly forbidden and requires the prior written approval of INNOVA. All data is the exclusive property of 9105-0732 QUEBEC INC. and under exclusive license to INNOVA and cannot be used nor disclosed in any way either without the prior written approval of INNOVA.</small>				
WEIGHT:	TITLE:			
34 Lb	140mm (5.5") Mast for extendable Davit-Arm IN-2197			
15 Kg				
COLOR:	Material:	SHEET(S):	PROJET:	Rev.
Safety Yellow	Aluminum	2 / 3	IN-2199	01

SPECIFICATIONS

H This equipment is considered as part of a personal fall arrest system (PFAS) with a maximum working capacity of 164 Kg (360 lb).

It is only to be used in conjunction with a personal fall arrest system that limits the maximum arrest force (MAF).

G Max Working load (mass):  
With Davit-Arm IN-2197: 164 kg (360 lb)  
Max working moment with Davit-Arm IN-2197: 3,905 N-m (34,560 lbf-in)

Max design capacity: with Davit-Arm IN-2197: 16,014 N (3,600 lbf)  
Max design moment with Davit-Arm IN-2197: 39,048 N-m (345,600 lbf-in)

STANDARDS

Meets the following standards:  
OSHA Personal fall arrest system - 1910.66 App C  
ANSI Safety requirements for personal fall arrest system, subsystems and components Z359.1 ( R1999 ) / 2007  
E CAN/CSA Fall arresters, vertical lifelines, and rails Z259.2.1-98  
EN 795: 2012 Type A  
TS 16415:2013 (3 USERS)

D MATERIAL AND CONSTRUCTION

Mast : Aluminum 6061-T6  
Handle : Aluminum 6061-T6  
Finish : Yellow security powder paint with metal protection base.  
Welding certification: CSA W47,2M

C RESTRICTIONS

This product is to be used only with products approved by Innova Public Utility Products inc.

**IMPORTANT :**  
\*\*The positioning pins must always be in place when manoeuvring personnel.  
Otherwise, serious injuries may occur.

Periodic inspections of hardware must be done.  
In the occurrence of a fall or the safety of the equipment is in doubt, equipment must be immediately removed from service and inspected by qualified personnel before reuse.

A \*\* This equipment must always be operated in a level position.

Product number: IN-2199

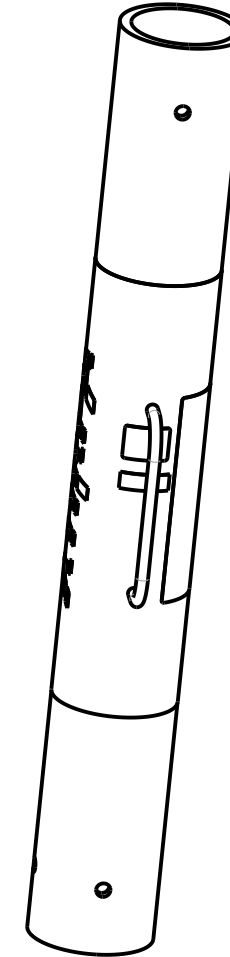

PAT.NO.:				
PRODUITS DE SERVICE PUBLICS INNOVA INC. INNOVA PUBLIC UTILITY PRODUCTS INC.				
<small>© 9105-0732 QUEBEC INC. and under exclusive license to INNOVA PUBLIC UTILITY PRODUCTS INC., (hereafter « INNOVA »). All rights reserved. Protected under the Copyright Act of Canada and international treaties and agreements regarding copyrights. Violators are subject to prosecution and other legal recourses for infringement. Any reproduction, adaptation or other use or disclosure whatsoever, in totality or in part, and in any form or by any means whatsoever, strictly forbidden and requires the prior written approval of INNOVA. All data is the exclusive property of 9105-0732 QUEBEC INC. and under exclusive license to INNOVA and cannot be used nor disclosed in any way either without the prior written approval of INNOVA.</small>				
WEIGHT:	TITLE:			
34 Lb	140mm (5.5") Mast			
15 Kg	for extendable Davit-Arm IN-2197			
COLOR:	Material:	SHEET(S):	PROJET:	Rev.
Safety Yellow	Aluminum	3 / 3	IN-2199	01