

LIFELINE SYSTEM

TEMP

Temporary horizontal lifeline system

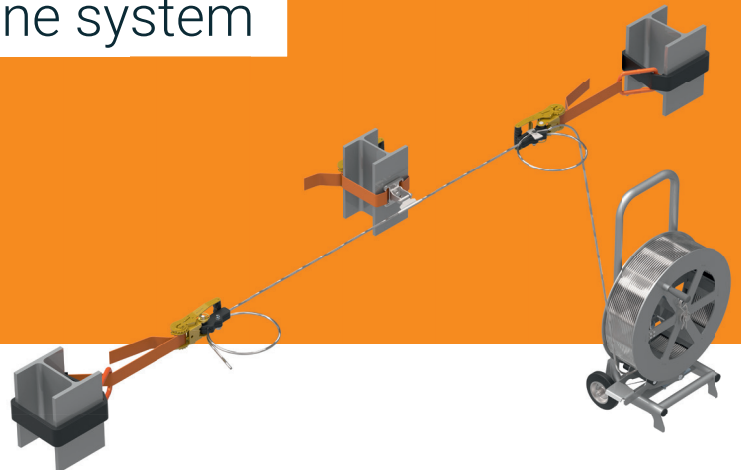
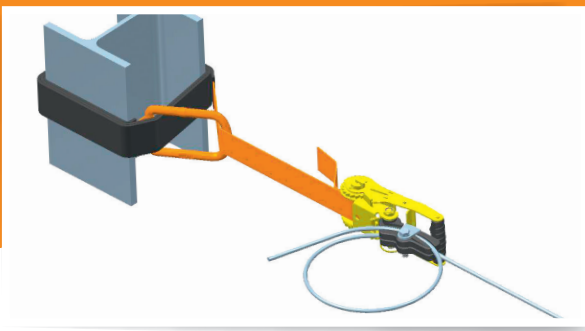

TEMP, the simple temporary horizontal lifeline system from INNOTECH is quickly installed and removed, and is therefore especially suitable for short-term installation requirements on building sites or on industrial construction sites having very varied support structures (steel, facade, warehouse, and bridge construction, etc.). A practical lashing strap ratchet and

a braked cable pulley with up to 150 m stainless steel cable provide the maximum possible flexibility for temporary use.

- Mobile lifeline system
- Ideal for steel, facade, warehouse, and bridge construction
- Adapts individually to very varied fastening options (round columns, steel construction, INNOTECH anchorage points)
- Simple and quick installation and removal
- Braked cable pulley with up to 150 m stainless steel cable
- End lock with integrated shock absorber
- Up to 20 m separation between intermediate brackets can be achieved
- Certification to the latest state of the art:

EN 795:2012 TYPES B and C
 CEN/TS 16415:2013

TEMP

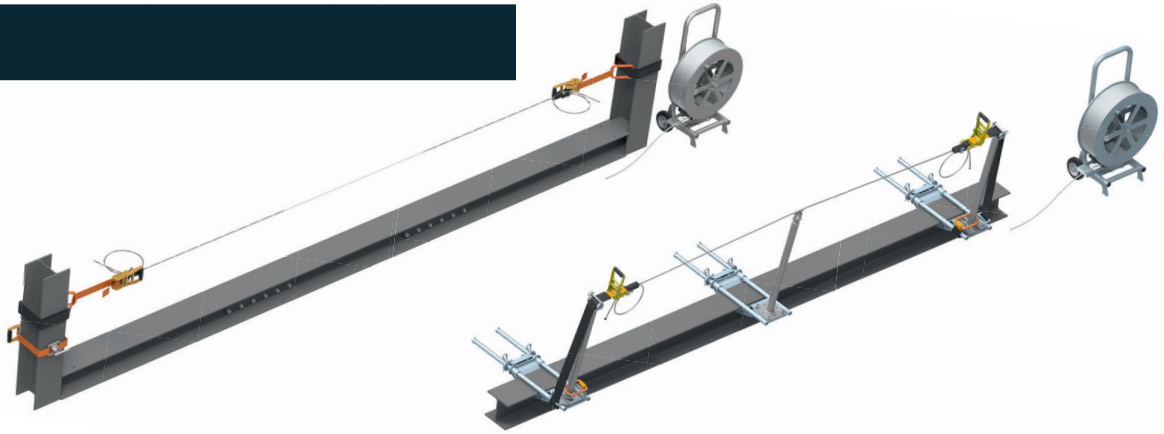

CABLE | STAINLESS STEEL

TEMP-HASPEL-10
MOBILE CABLE PULLEY

Material: stainless steel (AISI 316), galvanised steel, decelerated cable drum for the practical paying out and winding in of the stainless steel cable (AIO-SEIL-30)

TEMP-HASPEL-10-150 including 150 m stainless steel cable, weight ~85 kg

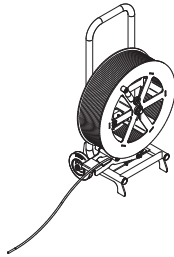

ENDS | END LOCK

TEMP-ENDS-10
TEMPORARY END LOCK SET
WITH INTEGRATED SHOCK ABSORBER (EN 795 B-C)

Substructure: steel or concrete support
Application: steel, facade, and bridge construction
Belt length: 4 m
Material: aluminium (anodised), plastic, galvanised steel
Complete set for one cable span (packing unit = 2 items)

can be quickly attached and removed at any point of the stainless steel cable (AIO-SEIL-30) – attachment by means of lashing strap on steel or concrete support

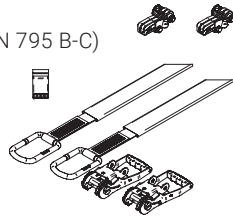

ENDS-10

Anodised aluminium, stainless steel A2, galvanised steel

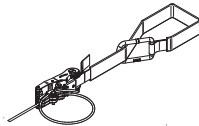

POLYESTER HARNESS STRAP

50 x 4000 mm with powder-coated steel end fitting and protective polyester hose with smooth PVC coating Ø 35 x 2000 mm

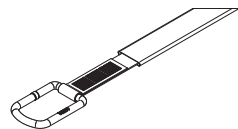

RATCHET

50 mm, 18 teeth, 5000 daN; made from galvanised steel, with plastic handle

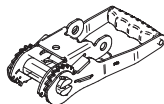

BEF | FASTENING

BEF-412
CLAMPING CONSOLE, STEEL CONSTRUCTION

Material: galvanised steel
Flange thickness: 10 to 40 mm
Width of steel girder: 125 to 415 mm

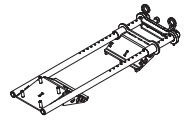

BEF-412-1
GUIDE PULLEY, STEEL CONSTRUCTION

Material: galvanised steel

for the creation of an end-point in a temporary lifeline system (TEMP-ENDS-10)

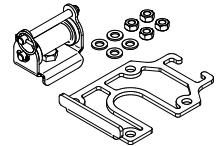

SZH | INTERMEDIATE BRACKET

TEMP-SZH-10
TEMPORARY INTERMEDIATE BRACKET (EN 795 B-C)

Material: aluminium (anodised), plastic, galvanised steel
Substructure: steel or concrete support
Application: steel, facade, and bridge construction
Belt length: 2.5 m

Attachment is made using a lashing strap on steel or concrete support (packing unit = 1 item)

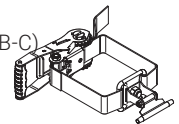

SZH-10

Stainless steel A2 and nickelled steel

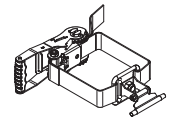

POLYESTER HARNESS STRAP WITH SEWN-IN RATCHET

50 x 2500 mm
50 mm, 18 teeth, 5000 daN; made from galvanised steel, with plastic handle

