



Instruction manual

DE – ACHTUNG: Die Verwendung des INNOTECH-Produkts ist erst zulässig, nachdem die Gebrauchsanleitung in der jeweiligen Landessprache vollständig gelesen und verstanden wurde.

EN – ATTENTION: Use of the INNOTECH product is only permitted after the instruction manual has been read and fully understood in the respective language.

IT – ATTENZIONE: L'utilizzo del prodotto INNOTECH è permesso solo previa lettura e comprensione dell'intero manuale di istruzioni nella lingua del relativo paese di utilizzo.

FR – ATTENTION : L'utilisation du produit INNOTECH n'est autorisée qu'après avoir entièrement lu et compris la notice d'utilisation dans la langue du pays concerné.

NL – ATTENTIE: Dit INNOTECH-product mag pas gebruikt worden nadat u de gebruikershandleiding in de taal van het betreffende land gelezen en begrepen hebt.

ES – ATENCIÓN: Se autorizará el uso de los productos INNOTECH una vez que se hayan leído y entendido las instrucciones de uso en el idioma del país.

PT – ATENÇÃO: O uso do produto INNOTECH apenas é permitido depois de ter lido e compreendido na totalidade as instruções de uso na respetiva língua nacional.

DK – GIV AGT: Du må først bruge et produkt fra Innotech, efter du har læst og forstået brugsvejledningen i fuldt omfang i dit lands sprog.

SV – O B S : Denna INNOTECH-produkt får inte användas förrän bruksanvisningen på respektive lands språk har lästs igenom och förståtts.

CZ – POZOR: Práce s výrobkem INNOTECH je povolena teprve po kompletním přečtení a porozumění návodu k použití v jazyku daného státu.

PL – UWAGA: Produkty firmy INNOTECH mogą być używane dopiero po dokładnym zapoznaniu się z całą instrukcją obsługi w ojczystym języku.

SL – POZOR: Uporaba izdelka INNOTECH je dovoljena šele po tem, ko ste navodila prebrali v celoti v ustreznem jeziku svoje dežele in jih tudi razumeli.

SK – POZOR: Produkt INNOTECH môžete používať až po prečítaní a porozumení celého návodu na použitie pre príslušnú krajinu.

HU – FIGYELEM: Az INNOTECH termékek használatra csak azt követően engedélyezett, hogy saját nyelvéen elolvasta és megértette a teljes használati utasítást.

TR – DİKKAT: INNOTECH ürününün kullanımına ancak ilgili ülkenin dilinde sunulmuş olan kullanım kılavuzunun tamamen okunmasından ve anlaşılmasından sonra izin verilir.

ZH – 注意 : 只有在仔细阅读并完全理解了当地语言的使用说明后，才能使用 INNOTECH 公司的产品。

[2]	EXPLANATION OF ICONS	3
[3]	SAFETY INSTRUCTIONS	4
[4]	COMPONENTS/MATERIAL	6
[5]	PRODUCT SUITABILITY/APPROVAL	6
[6]	INSPECTION	7
[7]	WARRANTY	8
[8]	SIGNS & MARKINGS	8
[9]	DIMENSIONS	9
[10]	INSTALLATION TOOLS	9
[11]	INSTALLATION	10
[12]	LOAD DIRECTIONS	12
[13]	STORAGE/DISPOSAL	12
[14]	DEVELOPMENT & SALES	13

Warning/danger information

For an IMMEDIATE threat of danger that can cause serious physical injuries or death.



For a POTENTIALLY dangerous situation that can cause serious physical injuries or death.



For a POTENTIALLY dangerous situation that could lead to minor physical injuries and damage to property.



Wear gloves!



Wear safety spectacles!

**Supplementary information/instructions**

Correct



Incorrect



Comply with manufacturer information/ instruction manual.

The following safety instructions and the current state of the art must be taken into consideration.

3.1 GENERAL INFORMATION

- The fall protection system may be installed and used only by people who:
 - are trained in the use of "personal protective equipment" (PPE),
 - are in good physical and mental health. (Medical conditions such as cardiovascular problems, intake of medicines, consumption of alcohol, etc. negatively affect the safety of the user.),
 - are familiar with the locally applicable safety regulations.
- During installation/use of the fall protection system, the respective accident prevention regulations (e.g. working on roofs) must be complied with.
- A plan must be available that specifies rescue procedures for all possible emergencies.
- Before starting work, ensure that no objects can fall to the ground from the work site. The area below the work site (pavement, etc.) must be kept clear.
- You should plan, install and use the fall protection system in such a way that no one can fall over the edge if the personal protective equipment is used properly (See planning documents at www.innotech.at).
- The fall protection system is subject to maximum limit values. These are found on the rating plate of the fall protection system, and must not be exceeded.
- When accessing the fall protection system, you must document the positions of the anchorage devices by means of plans (e.g. top view of the roof).
- After a fall and the resulting load, the use of the fall protection system must be stopped, and it must be checked by a specialised expert (component parts, attachment to the substructure, etc.).
- Do not make any changes to the fall protection system.
- If you provide the fall protection system to external contractors, their understanding of this instruction manual must be confirmed in writing.
- If the fall protection system is sold to other countries, the instruction manual must be provided in the respective national language.
- Comply with the customary national provisions for lightning protection.

3.2 FOR FITTERS: FOR SAFE ASSEMBLY

- Ensure that stainless steel does not get in contact with swarf or steel tools, as this can lead to corrosion.
- All stainless steel bolts must be greased with a suitable lubricant before installation.
- The fitters must ensure that the substructure is suitable for fastening the fall protection system. If in doubt, consult a structural engineer.
- The roof covering must be properly sealed in accordance with applicable guidelines.
- Document the professional attachment of the fall protection system to the building structure with dowel logs and photos of each fitting situation.



If uncertainties arise during installation, it is imperative that you contact the manufacturer.

3.3 FOR USERS: FOR SAFE USE

- Attachment to the fall protection system is made by means of INNOTECH sliders (e.g. AIO-GLEIT-10, -11, -12, -13 or -20). Use the INNOTECH slider only in combination with the original carabiner, the INNOTECH "ALLinONE" horizontal lifeline system, and personal protective equipment complying with EN 361 (safety harness) and EN 363 (fall arrest system).
- The minimum free space necessary under the edge is calculated as follows: Manufacturer's specification of the personal protective equipment used, including deflection of the cable + body height + 1 m safety margin.
- For horizontal use, only those fasteners may be used that are suited for this purpose and have been tested for the respective edges (sharp edges, trapezoidal sheets, steel girders, concrete, etc.).
- Correct use of the individual elements including personal protective equipment must be ensured, because otherwise the safe functioning of the fall protection system is NOT guaranteed.
- Do not use fall protection systems if wind speeds exceed normal parameters.
- If used on sloping roofs, roof avalanches (ice, snow) must be avoided by means of suitable devices to intercept snow.
- You must set up secure access to the slider ("parking position for slider").

4

COMPONENTS/MATERIAL

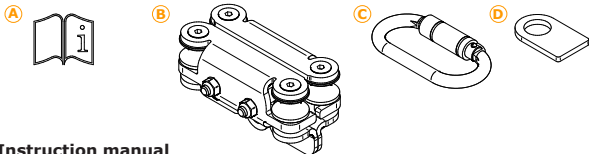

A) Instruction manual

B) INNOTECH "AIO-GLEIT-12": stainless steel, AISI 304

C) INNOTECH "TRIPLE-LOCK CARABINER": stainless steel, AISI 304

D) INNOTECH "GAP REFERENCE GAUGE": Stainless steel, AISI 304

5

PRODUCTSUITABILITY/APPROVAL

INNOTECH "AIO-GLEIT-12" is part of the INNOTECH "ALLinONE" horizontal lifeline system, and is characterised by resistance-free passage along the stainless steel cable. INNOTECH "AIO-GLEIT-12" is above all suitable for **overhead systems** and is used as a **mobile anchorage point for 1 person**.



DANGER TO LIFE from incorrect use.

- Use INNOTECH "AIO-GLEIT-12" ONLY for personal safety.
- Use INNOTECH "AIO-GLEIT-12" ONLY in combination with
 - INNOTECH "ALLinONE" horizontal lifeline system and
 - INNOTECH original carabiners and
 - personal protective equipment as per EN 361 (safety harness) and EN 363 (fall arrest system).
- NEVER hang loads to the INNOTECH "AIO-GLEIT-12" which are NOT expressly approved in this instruction manual.



Comply with the manufacturer information for the personal protective equipment used.

INNOTECH "AIO-GLEIT-12" has been tested and certified in accordance with **EN 795:2012 TYPE C**.

The notified authority participating in the type test:

DEKRA EXAM GmbH, Dinnendahlstrasse 9, D-44809 Bochum, Germany

Safety harnesses and lanyard lengths must be matched to the respective structure, and must satisfy the applicable standards.

Every person working in areas where there is a danger of falling must pay attention to the fall height.

The connection to the anchorage device must be kept short in order to limit free fall.

6.1 TO BE CHECKED BEFORE EACH USE

Prior to every use, INNOTECH "AIO-GLEIT-12" must be checked visually for any obvious defects.



DANGER

DANGER TO LIFE from damage to the INNOTECH "AIO-GLEIT-12".

- INNOTECH "AIO-GLEIT-12" must be in perfect condition.
- Check that the running rollers move easily.
- Do NOT continue to use INNOTECH "AIO-GLEIT-12" any more if
 - Damage or wear to its components are obvious,
 - Other defects were observed (loose threaded connections, deformation, corrosion, wear, bearing damage, tilting of the running rollers, etc.),
 - Strain has occurred due to a fall.
 - The product identification is illegible.

Check the entire fall protection system's suitability for use by using the acceptance protocol and test log.



**If there are any doubts concerning the reliable operation of the fall protection system, it must NO longer be used, and must be checked by an expert (written documentation).
If necessary, replace the product.**

6.2 ANNUAL CHECKS

Have INNOTECH "AIO-GLEIT-12" inspected at least once each year by a specialist who is familiar with the fall protection system. The user's safety depends on the effectiveness and durability of the equipment.

Shorter intervals between inspections may be required, depending on the intensity of use and the environment (e.g. in corrosive atmospheres, etc.).

Document the verification by the specialist/technician in the INNOTECH "ALLinONE" instruction manual test logs, and keep them in the same place as the instruction manual.



The inspection intervals are found in the test log.

7

WARRANTY

The warranty period for manufacturing defects on all components (under normal conditions of use) is 2 years from the date of purchase. The time limit is shortened through use in corrosive atmospheres.

If there is strain (a fall, weight of snow, etc.,) the warranty claim is void for those components that have been designed to absorb energy, or that may possibly be deformed.



For system installation and for components planned and installed under the responsibility of specialised installation companies, INNOTECH assumes neither responsibility nor warranty in the case of improper installation.

8

SIGNS & MARKINGS

- | | |
|--|--------------------|
| A) Name or logo of the manufacturer/reseller: | INNOTECH |
| B) Type designation: | AIO-GLEIT-12 |
| C) Signs stating that instructions in the manual must be followed: | |
| D) Maximum number of people who can be secured: | 1 |
| E) Year of manufacture and manufacturer's serial number: | JJJJ-.. |
| F) Number of the applicable standard: | EN 795:2012 TYPE C |



9

DIMENSIONS

[mm]

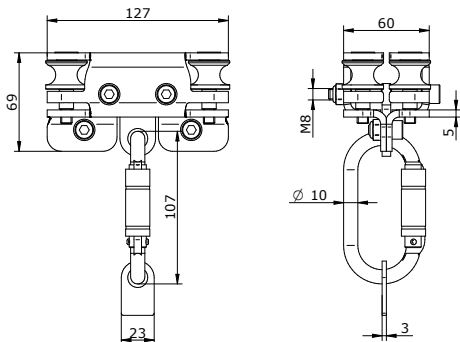

10

INSTALLATION TOOLS

[mm]

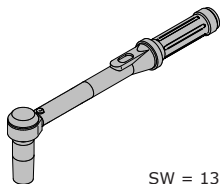

SW = 13

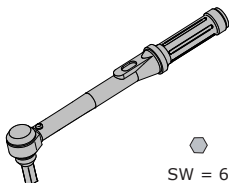

SW = 6

11

INSTALLATION

1.

Place both halves onto the INNOTECH "AIO-SEIL-30".

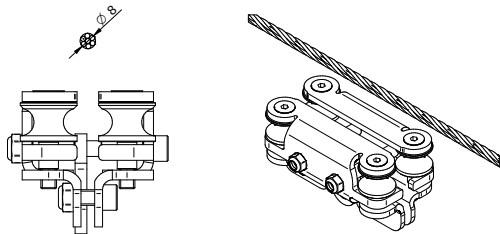

2.

Screw both bolts tightly using the lock nuts.



SW = 13



SW = 6

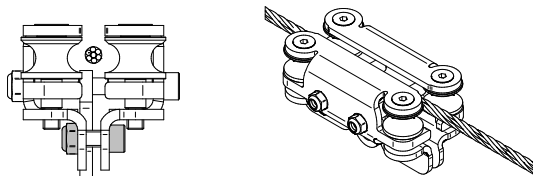

2 x 18 Nm



Comply with the prescribed torque.

3.

Use the set screws to adjust to a gap of 3 mm.



SW = 13

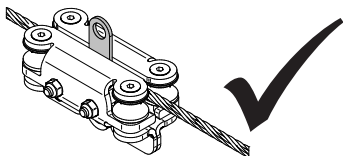
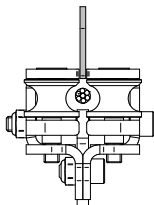
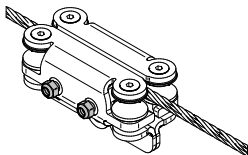
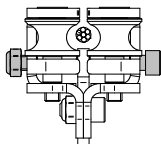

SW = 6

**DONE!**

In the closed state, the gap must NOT exceed 3 mm.

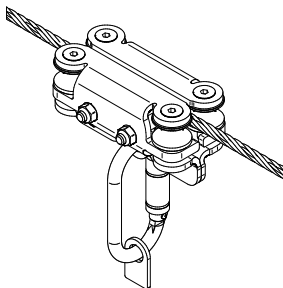
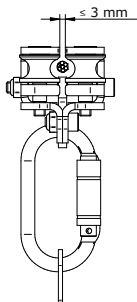

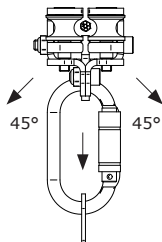

DANGER TO LIFE when used in **UNAPPROVED** load directions.

- Use INNOTECH "AIO-GLEIT-12" ONLY in the approved load direction.

13.1 STORAGE

Keep INNOTECH "AIO-GLEIT-12" free of grease, ice, and snow.

Keep INNOTECH "AIO-GLEIT-12" together with the personal protective equipment.

13.2 WASTE DISPOSAL

Do NOT dispose the fall protection system in the house waste.
As per national requirements, gather together the used parts, and dispose of them environmentally correctly.

INNOTECH Arbeitsschutz GmbH, Laizing 10, 4656 Kirchham, Austria
www.innotech.at

