



## Instruction manual

**DE – ACHTUNG:** Die Verwendung des INNOTECH-Produkts ist erst zulässig, nachdem die Gebrauchsanleitung in der jeweiligen Landessprache vollständig gelesen und verstanden wurde.

**EN – ATTENTION:** Use of the INNOTECH product is only permitted after the instruction manual has been read and fully understood in the respective language.

**IT – ATTENZIONE:** L'utilizzo del prodotto INNOTECH è permesso solo previa lettura e comprensione dell'intero manuale di istruzioni nella lingua del relativo paese di utilizzo.

**FR – ATTENTION :** L'utilisation du produit INNOTECH n'est autorisée qu'après avoir entièrement lu et compris la notice d'utilisation dans la langue du pays concerné.

**NL – ATTENTIE:** Dit INNOTECH-product mag pas gebruikt worden nadat u de gebruikershandleiding in de taal van het betreffende land gelezen en begrepen hebt.

**ES – ATENCIÓN:** Se autorizará el uso de los productos INNOTECH una vez que se hayan leído y entendido las instrucciones de uso en el idioma del país.

**PT – ATENÇÃO:** O uso do produto INNOTECH apenas é permitido depois de ter lido e compreendido na totalidade as instruções de uso na respetiva língua nacional.

**DK – GIV AGT:** Du må først bruge et produkt fra Innotech, efter du har læst og forstået brugsvejledningen i fuldt omfang i dit lands sprog.

**SV – O B S :** Denna INNOTECH-produkt får inte användas förrän bruksanvisningen på respektive lands språk har lästs igenom och förstås.

**CZ – POZOR:** Práce s výrobkem INNOTECH je povolena teprve po kompletním přečtení a porozumění návodu k použití v jazyku daného státu.

**PL – UWAGA:** Produkty firmy INNOTECH mogą być używane dopiero po dokładnym zapoznaniu się z całą instrukcją obsługi w ojczystym języku.

**SL – POZOR:** Uporaba izdelka INNOTECH je dovoljena šele po tem, ko ste navodila prebrali v celoti v ustreznem jeziku svoje dežele in jih tudi razumeli.

**SK – POZOR:** Produkt INNOTECH môžete používať až po prečítaní a porozumení celého návodu na použitie pre príslušnú krajinu.

**HU – FIGYELEM:** Az INNOTECH termékek használatá csak azt követően engedélyezett, hogy saját nyelvéen elolvasta és megértette a teljes használati utasítást.

**TR – DİKKAT:** INNOTECH ürününün kullanımına ancak ilgili ülkenin dilinde sunulmuş olan kullanım kılavuzunun tamamen okunmasından ve anlaşılmasından sonra izin verilir.

**ZH – 注意 :** 只有在仔细阅读并完全理解了当地语言的使用说明后，才能使用 INNOTECH 公司的产品。

|      |                                      |    |
|------|--------------------------------------|----|
| [2]  | EXPLANATION OF ICONS                 | 3  |
| [3]  | SAFETY INSTRUCTIONS                  | 4  |
| [4]  | COMPONENTS/MATERIAL                  | 6  |
| [5]  | PRODUCT SUITABILITY/APPROVAL         | 6  |
| [6]  | INSPECTION                           | 7  |
| [7]  | WARRANTY                             | 8  |
| [8]  | SIGNS & MARKINGS                     | 8  |
| [9]  | DIMENSIONS                           | 9  |
| [10] | INSTALLATION SUBSTRUCTURE            | 9  |
| [11] | INSTALLATION TOOL                    | 12 |
| [12] | INSTALLATION                         | 12 |
| [13] | LOAD DIRECTIONS                      | 14 |
| [14] | WASTE DISPOSAL                       | 14 |
| [15] | ACCEPTANCE LOG                       | 15 |
| [16] | INFORMATION – FALL PROTECTION SYSTEM | 17 |
| [17] | TEST LOG                             | 18 |
| [18] | DEVELOPMENT & SALES                  | 20 |

**Warning/danger information**

For an IMMEDIATE threat of danger that can cause serious physical injuries or death.



For a POTENTIALLY dangerous situation that can cause serious physical injuries or death.



For a POTENTIALLY dangerous situation that could lead to minor physical injuries and damage to property.



Wear gloves!



Wear safety spectacles!

**Supplementary information/instructions**

**Correct**



**Incorrect**



Comply with manufacturer information/instruction manual.

The following safety instructions and the current state of the art must be taken into consideration.

## 3.1 GENERAL INFORMATION

- The fall protection system may be installed only by specialised experts familiar with the fall protection system, and in compliance with the current state of the art.
- The protective equipment may be used only by people who are trained
  - in the use of "personal protective equipment" (PPE).
  - are in good physical and mental health. Medical conditions such as cardiovascular problems, intake of medicines, consumption of alcohol, etc. negatively affect the safety of the user.
  - are familiar with the locally applicable safety regulations.
- During installation/use of the fall protection system, the respective accident prevention regulations (e.g. working on roofs) must be complied with.
- Understand and accept the options, restrictions, and risks of the protective equipment.
- A plan must be available that specifies rescue procedures for all possible emergencies.
- Before starting work, ensure that no objects can fall to the ground from the work site. The area below the work site (pavement, etc.) must be kept clear.
- You should plan, install, and use the anchorage point in such a way that no one can fall over the edge if the personal protective equipment (PPE) is used properly. (See planning documents on [www.innotech.at](http://www.innotech.at))
- At the access to the roof fall protection system, you must document the positions of the attachment devices by means of plans (e.g. top view of the roof).
- If following the certification of the fall protection system, structural changes are carried out in the immediate vicinity of the fall protection system, it must be ensured that these changes do not affect the security of the installed fall protection system! Where there is any doubt, consult a structural engineer or the manufacturer.
- After a fall and the resulting load, the use of the fall protection system must be stopped, and it must be checked by a specialised expert (component parts, attachment to the substructure, etc.).
- Do not make any changes to the fall protection system.
- If used on sloping roofs, roof avalanches (ice, snow) must be avoided by means of suitable devices to intercept snow.

- If you provide the fall protection system to external contractors, understanding of with this instruction manual must be confirmed in writing.
- If the equipment is sold to other countries, the instruction manual must be provided in the respective national language!
- Comply with the customary national provisions for lightning protection.

### 3.2 FOR FITTERS: FOR SAFE ASSEMBLY

- All stainless steel bolts must be greased with a suitable lubricant before installation (included: Weicon AntiSeize ASW 10000, or of same quality)
- Ensure that stainless steel does not get in any contact with swarf or steel tools, as this may lead to corrosion.
- Document the professional attachment of the fall protection system to the building structure with dowel logs and photos of each fitting situation.
- The fitters must ensure that the substructure is suitable for fastening the anchorage device. If in doubt, consult a structural engineer.
- The roof covering must be properly sealed in accordance with applicable guidelines.



If uncertainties arise during installation, it is imperative that you contact the manufacturer.

### 3.3 FOR USERS FOR SAFE USE

- The minimum free space necessary under the edge is calculated as follows: Deformation of the anchorage device in the event of strain + Manufacturer's specification of the personal protective equipment used including deflection of the cable + body height + 1 m safety margin.
- Correct use of the individual elements including "personal protective equipment" must be ensured, because otherwise the safe functioning of the fall protection system is NOT guaranteed.
- Attachment to the fall protection system is always executed with one carabiner through the rotating anchorage eye, and this must be used with personal protective equipment in accordance with EN 361 (safety harness) and EN 363 (fall arrest system).
- **ATTENTION!** For horizontal use, only lanyards may be used that are suited for this purpose and have been tested for the respective edges (sharp edges, trapezoidal sheets, steel girders, concrete, etc.).
- Do NOT use fall protection systems if wind speeds exceed normal parameters.
- The fall protection system must NOT be used by children and pregnant women.

## 4

## COMPONENTS/MATERIAL

A)



B)



C)

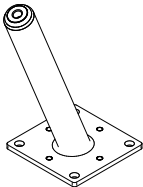

A) **Instruction manual**

B) **Lubricant:** Weicon AntiSeize ASW10000

C) **INNOTECH standard posts:** Hot-dipped galvanised/foamed

## 5

## PRODUCT SUITABILITY/APPROVAL

INNOTECH "AIO-STA-11" has been

- approved as **attachment point** for personal safety **for end and corner points and intermediate brackets** (not contained in scope of delivery) in the **INNOTECH horizontal lifeline system in accordance with EN 795:2012 & CEN/TS 16415:2013 TYPE C** and
- approved as **anchorage point** for the personal safety of **4 people** (including 1 person for the provision of first aid) **in accordance with EN 795:2012 & CEN/TS 16415:2013 TYPE A** (EAP-SPAR-10-25) and it is suitable for the following fall protection systems in accordance with EN 363:2008:

- Restraint systems
- Workplace positioning systems
- Fall arrest systems
- Rescue systems

Approved as an **anchorage point** on a flat or inclined roof **for INNOTECH "ABP-10-30"**.

- Rope access systems (EN 363:2008)



**DANGER**

**DANGER TO LIFE from incorrect use.**

- Use INNOTECH standard posts **ONLY** for personal safety.
- **NEVER** hang loads to INNOTECH standard posts that have not been approved in this instruction manual.



**Comply with the manufacturer information for the personal protective equipment used.**

INNOTECH "AIO-STA-11" has been tested and certified in accordance with **EN 795:2012 & CEN/TS 16415:2013 TYPE C**.

The notified authority participating in the type test:

DEKRA EXAM GmbH, Dinnendahlstr. 9, 44809 Bochum, Germany

## 6.1 TO BE CHECKED BEFORE EACH USE

Prior to each use, INNOTECH standard posts must be checked visually for any obvious defects.



**DANGER TO LIFE through damage to INNOTECH standard posts.**

- INNOTECH standard posts must be in faultless condition.
- INNOTECH standard posts must NO longer be used, if
  - Damage or wear to its components are obvious,
  - Other defects were observed (loose threaded connections, deformation, corrosion, wear, etc.),
  - Strain has occurred due to a fall (Exception: provision of first aid),
  - The product identification is illegible.

Check the entire fall protection systems's suitability for use by using the acceptance protocol and test log.



**If there are any doubts concerning the reliable operation of the fall protection system, it must NO longer be used, and must be checked by an expert (written documentation).  
If necessary, replace the product.**

## 6.2 ANNUAL CHECKS

INNOTECH standard posts must be inspected at least once a year by a specially trained technician who is familiar with the fall protection system. The user's safety depends on the effectiveness and durability of the equipment.

Shorter intervals between inspections may be required, depending on the intensity of use and the environment (e.g. in corrosive atmospheres, etc.).

Document the verification by the specialist in the test log in the instruction manual, and keep it with the instruction manual.



**The inspections intervals are found in the test log.**

## 7

## WARRANTY

The warranty period for manufacturing defects on all components (under normal conditions of use) is 2 years from the date of purchase. The time limit is shortened through use in corrosive atmospheres.

If there is strain (a fall, weight of snow, etc.,) the warranty claim is void for those components that have been designed to absorb energy, or that may possibly be deformed.



**For system installation and for components planned and installed under the responsibility of specialised installation companies, INNOTECH® assumes neither responsibility nor warranty in the case of improper installation.**

## 8

## SIGNS &amp; MARKINGS

A) Name or logo of the manufacturer/reseler:

INNOTECH®

B) Type designation:

AIO-STA-11

C) Signs stating that instructions in the manual must be followed:



D) Year of manufacture and manufacturer's serial number:

JJJJ-....

E) Number of the applicable standard:

EN 795:2012 &  
CEN/TS 16415:2013 TYPE C





[mm]

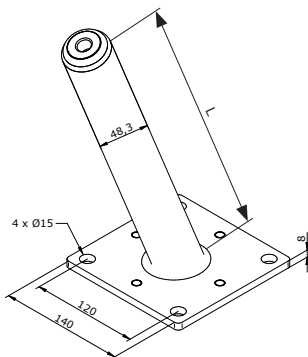

Standard length (L): 340/470 mm  
(Special lengths upon request)

## 10

## INSTALLATION SUBSTRUCTURE

## 10.1 CONCRETE

The basic prerequisite for professional/proper installation is static load-bearing **construction concrete (solid concrete)** with a **concrete quality of at least C20/25** and use of the original fasteners listed in this instruction manual.

**DANGER TO LIFE as a result of installation on an unsuitable substructure.**



DANGER

- Install INNOTECH standard post on a static load-bearing construction concrete (solid concrete) with a concrete quality of at least C20/25.
- **DO NOT install on screed, levelling concrete, blinding concrete etc....**
- In case of doubt, have the installation substructure checked by a structural engineer or by the manufacturer.

**INNOTECH "BEF-104"**

4x. concrete anchor

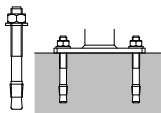
**ADHESIVE ANCHOR**Adhesive anchor with 4x threaded rods M12, washer,  
lock nut M12 or nut with spring-lock washer

Thread penetration depth in concrete at least 100 mm

Injection mortar: FISCHER FIS SB 390 S

HILTI HY 200

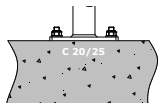

Only use products from other manufacturers with technical specifications of equal value (compare with product data sheets).

**10.2 TIMBER CONSTRUCTION****INNOTECH "BEF-201"**

8x fastening bolts 8.0 x 140 mm (T40) and 8x washers

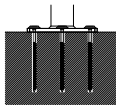
**INNOTECH "BEF-203"**

Steep roof fastening bar

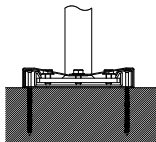
**INNOTECH "BEF-206"**

Ridge installation

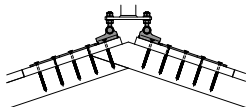

**INNOTECH "BEF-403"**

Counter strips

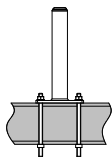
**10.3 TRAPEZOIDAL SHEETING****INNOTECH "BEF-303"**

Trapezoidal metal sheeting frame

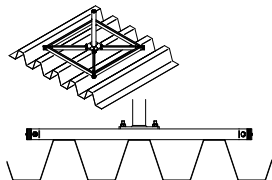
**10.4 STEEL CONSTRUCTION****INNOTECH "BEF-401-10"**

Counter plate

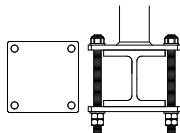
**INNOTECH "BEF-412"**

Clamping console

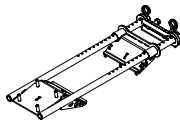
**STEEL SCREWS**

4x steel screws M12, quality grade  $\geq 5,6$   
with lock nut M12 or nut with spring-lock washer  
use suitable washers on the 4 corner bores.

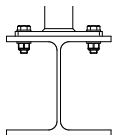
**WELDING**

Weld seam at least A5 and 80 mm length depending  
on the base plate side.

The powder coating and the zinc coating must be properly  
removed prior to welding.

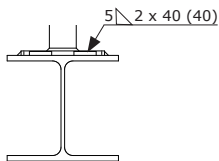

# 11

## INSTALLATION TOOL

[mm]

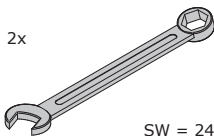

# 12

## INSTALLATION



**DANGER**

**DANGER TO LIFE if NOT properly installed.**

- Properly install INNOTECH standard posts as specified in the instruction manual.

### 12.1 INNOTECH "AIO ATTACHED PART"

#### 1.

Mount the appropriate attached part (e.g. AIO-SZH, AIO-EDLE, AIO-EB, etc.) on the INNOTECH standard posts.

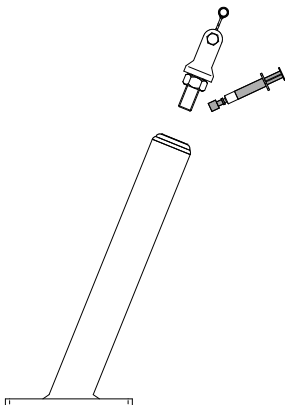

# 12

## INSTALLATION

2.

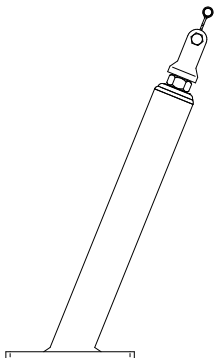

3.

[mm]

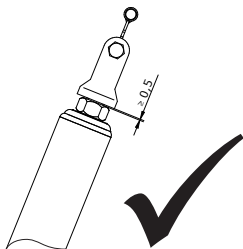

**DONE!**

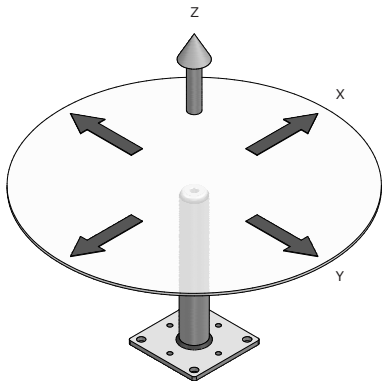

**DANGER TO LIFE** when used in **UNAPPROVED** load directions.

- Only use INNOTECH posts in the approved load directions.

Do NOT dispose of the fall protection system in the house waste. As per national requirements, gather together the used parts, and dispose of them environmentally correctly.

## ACCEPTANCE LOG NO. \_\_\_\_\_ (PART 1/2)

A I O - S T A - 1 1

ORDER NUMBER: \_\_\_\_\_

PROJECT: \_\_\_\_\_

CLIENT: \_\_\_\_\_ Specialist: \_\_\_\_\_ 

Company address: \_\_\_\_\_

CONTRACTOR: \_\_\_\_\_ Specialist: \_\_\_\_\_ 

Company address: \_\_\_\_\_

**INSTALLATION:** ( please tick as appropriate!) **EAP** (single anchorage points) **ANCHORAGE POINTS** of a horizontal lifeline system in accordance  
with EN 795:2012 TYPE CSpecialist: \_\_\_\_\_ 

Company address: \_\_\_\_\_

OPTIONAL: For set up of a horizontal lifeline system in accordance  
with EN 795:2012 TYPE C

Installation of the anchorage points by: \_\_\_\_\_

Installation of the lifeline system through: \_\_\_\_\_

# 15 COPY TEMPLATE ACCEPTANCE LOG

## ACCEPTANCE LOG NO. \_\_\_\_\_ (PART 2/2)

A I O - S T A - 1 1

### FASTENER & PHOTO DOCUMENTATION

**PRODUCT:**  Item \_\_\_\_\_ Year of construction/Serial number: \_\_\_\_\_

(Type designation EAP/anchorage point)

**Installation substructure:** \_\_\_\_\_

(e.g. solid concrete, concrete quality: C20/25, wood rafter dimension, for sheet metal roofs: roof manufacturer, profile, material, sheet metal thickness, etc.)

| Date: | Location: | Dowel type:<br>BEF/Sticker?/<br>Designation | Setting<br>depth:<br>[mm] | Drill bit Ø:<br>[mm] | Tightening<br>torque: | Photos:<br>(storage<br>location) |
|-------|-----------|---|---------------------------|----------------------|-----------------------|----------------------------------|
|       |           |   | mm                        | mm                   | Nm                    |                                  |
|       |           |   | mm                        | mm                   | Nm                    |                                  |

The installation company who signs warrants proper workmanship (edge spacing, inspection of the substructure, proper cleaning of bores, compliance with curing times and processing temperature, compliance with the dowel manufacturer's guidelines, etc.)

The client accepts the work performed by the contractor. The instruction manual, documentation of the anchorage points/photo documentation and test logs have been transferred to the client (building owner) and have been made available to the user.

Near the system access to the fall protection system, the positions of the anchorages must be documented by the building owner through plans (e.g. top view of the roof).

**The expert fitter familiar with the fall protection system confirms that the installation tasks have been executed properly, in accordance with the state of the technology, and in accordance with the manufacturer's instruction manual.**

**The technical safety reliability is confirmed by the installation company.**

**Handover of:** (e.g. Personal protective equipment PPE, fall arrest devices HSG, storage cabinet, etc.)

Item \_\_\_\_\_  Item \_\_\_\_\_  Item \_\_\_\_\_  Item \_\_\_\_\_

Integrated in the existing lightning protection system?  YES  NO

**Comments:** \_\_\_\_\_

Name: \_\_\_\_\_  
Client

Inspection: Contractor (expert who is familiar  
with the fall protection system)

\_\_\_\_\_  
Date, company stamp, signature

\_\_\_\_\_  
Date, company stamp, signature



**INFORMATION FOR THE EXISTING  
FALL PROTECTION SYSTEM**

**The building owner must affix this notice in a conspicuous location near the access to the system.**

This system must be used in accordance with the state of the art and the instruction manual.

The storage location for the instruction manual, test logs, etc. is:

- Overview template showing the position of the anchorage device:

**Draw in the areas where there is a break-through hazard  
(e.g. light domes and/or roof lights).**

The maximum limit values of the anchorage devices are to be found in the respective instructions and on the rating plate of the fall protection system.

If there is strain caused by fall, or if in doubt, the anchorage device must be taken out of service immediately and sent to the manufacturer, or to a specialised workshop for inspection and repair.  
This applies if there is damage to the anchorage equipment.

## TEST LOG NO. \_\_\_\_\_ (PART 1/2)

A I O - S T A - 1 1

ORDER NUMBER: \_\_\_\_\_

**PROJECT:** \_\_\_\_\_

**PRODUCT:**  Item \_\_\_\_\_ Year of construction/Serial number: \_\_\_\_\_

(Type designation EAP/anchorage point)

ANNUAL SYSTEM INSPECTION EXECUTED ON: \_\_\_\_\_

LATEST DATE FOR NEXT ANNUAL SYSTEM INSPECTION: \_\_\_\_\_

**CLIENT:** \_\_\_\_\_ Specialist: \_\_\_\_\_ 

Company address: \_\_\_\_\_

**CONTRACTOR:** \_\_\_\_\_ Specialist: \_\_\_\_\_ 

Company address: \_\_\_\_\_

|   |   |
|---|---|
| <b>INSPECTION POINTS:</b><br><input checked="" type="checkbox"/> checked and in order!  | <b>DEFECTS DETECTED:</b><br>(Description of defects/measures) |
| <b>DOCUMENTATION:</b>   |   |
| <input type="checkbox"/> Instruction manual   |   |
| <input type="checkbox"/> Acceptance logs/documentation of the anchorage/<br>photo documentation   |   |
| <b>PPE (personal protective equipment against falls from a height):</b><br><b>Inspection in accordance with manufacturer's specifications</b> |   |
| <input type="checkbox"/> Expiration date  |   |
| <input type="checkbox"/> Annual inspection performed  |   |
| <input type="checkbox"/> Not checked (no authorisation)   |   |
| <b>ROOF SEALING:</b>  |   |
| <input type="checkbox"/> No damage  |   |
| <input type="checkbox"/> No corrosion   |   |
| <input type="checkbox"/> .....  |   |

## TEST LOG NO. \_\_\_\_\_ (PART 2/2)

A I O - S T A - 1 1

ORDER NUMBER: \_\_\_\_\_

PROJECT: \_\_\_\_\_

| INSPECTION POINTS:  | DEFECTS DETECTED:                 |
|---|-----------------------------------|
| <input checked="" type="checkbox"/> checked and in order!   | (Description of defects/measures) |
| <b>VISIBLE PARTS OF THE ANCHORAGE DEVICE:</b>   |                                   |
| <input type="checkbox"/> No deformation   |                                   |
| <input type="checkbox"/> No corrosion   |                                   |
| <input type="checkbox"/> Firmly seated  |                                   |
| <input type="checkbox"/> Threaded joints secured  |                                   |
| <input type="checkbox"/> Tightening torque of the fastening bolts   |                                   |
| <input type="checkbox"/> Mobility of the attached parts (EAP, SZH, EDLE, etc)   |                                   |
| <b>HORIZONTAL LIFELINE SYSTEM:</b>  |                                   |
| <b>Attention:</b><br>For horizontal lifeline systems the test log of the AllinOne TYPE instruction manual (see copy template in the instruction manual) must be filled out! |                                   |

**Acceptance result:** The fall protection system corresponds to the specifications in the manufacturer's instruction manual and to the state of the art. Technical safety reliability is confirmed.

Comments: \_\_\_\_\_

Name: \_\_\_\_\_

Client

Inspection: Contractor (expert who is familiar with the fall protection system)

\_\_\_\_\_  
Date, company stamp, signature\_\_\_\_\_  
Date, company stamp, signature

INNOTECH® Arbeitsschutz GmbH, Laizing 10, 4656 Kirchham/Austria  
[www.innotech.at](http://www.innotech.at)

