

Flexible HWPS 24

according to FprEN360:2022

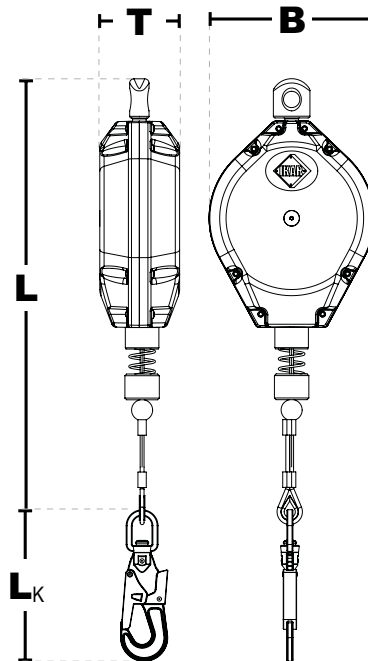

IKV 21 (EN 362:2004-T)
with fall indicator



IKAR retractable type fall arrester have been successfully tested in a simulated fall trial over and edge according to FprEN360:2022 ($r \geq 0,5$ mm).

Explanations of the device names:

- H = Retractable type fall arrester
- W = Swivel attachment point
- S = Steel lifeline
- B = Webbing lifeline
- P = Plastic housing
- Number = Operational length of the device

Product information:

Order No:	Application length	Housing	Weight	Dimensions (LxBxT)	Connector (L_K) IKV 21
41-HWPS 24	24,0 m	Plastic	8,8 kg	555 x 260 x 98 mm	185,5 mm

Features

Retractable type fall arrester with internal energy absorber.

- Sturdy and low-maintenance retractable type fall arrester.
- Lightweight and robust ABS plastic housing with a rotational attachment eye.
- The rotational attachment eye prevents the galvanized steel lifeline from twisting.
- Lifeline made of galvanized steel \varnothing 4,8 mm.
- Standard connector IKV 21 with swivel attachment, which prevents twisting of the galvanized steel lifeline.
- Nominal load: 136 kg
- Temperature range of application: -40°C bis $+50^{\circ}\text{C}$
- Lifespan: approx 10 years