

SAND-01



CZ – POZOR: Práce s výrobkem INNOTECH je povolena teprve po kompletním přečtení a porozumění bezpečnostních pokynů a návodu k montáži.

DE – ACHTUNG: Die Verwendung des INNOTECH-Produkts ist erst zulässig, nachdem die Sicherheitshinweise und Montageanleitung vollständig gelesen und verstanden wurden.

DK – GIV AGT: Det er først tilladt at anvende INNOTECH-produktet, efter du har læst og forstået sikkerhedshenvisningerne og monteringsvejledningen.

EN – ATTENTION: Use of the INNOTECH product is permitted only after the safety instructions and instruction manual in the respective language have been read.

ES – ATENCIÓN: Solo se autorizará el uso del producto INNOTECH una vez que se hayan leído y entendido completamente las indicaciones de seguridad y las instrucciones de montaje.

FR – ATTENTION : L'utilisation du produit INNOTECH n'est autorisée qu'après avoir intégralement lu et compris les consignes de sécurité et la notice de montage.

HU – FIGYELEM: Az INNOTECH termék használatát csak akkor engedhető meg, ha a biztonsági utasításokat és az összeszerelési utasításokat teljes mértékben elolvasta és megértette.

IT – ATTENZIONE: L'utilizzo del prodotto INNOTECH è permesso solo previa lettura completa e comprensione integrale delle avvertenze di sicurezza e le istruzioni di montaggio.

NL – ATTENTIE: Dit INNOTECH-product mag pas worden gebruikt nadat u de gebruikershandleiding en de montagehandleiding volledig heeft gelezen en begrepen.

PL – UWAGA: Używanie produktu INNOTECH jest dozwolone dopiero po zapoznaniu się z wszystkimi zasadami bezpieczeństwa i instrukcją montażu.

PT – ATENÇÃO: O uso do produto INNOTECH apenas é permitido depois de terem sido lidas e compreendidas na totalidade as indicações de segurança e o manual de montagem.

SK – POZOR: Používanie výrobku INNOTECH je povolené až vtedy, keď si úplne prečítate a pochopíte bezpečnostné pokyny a montážny návod.

SL – POZOR: Uporaba izdelkov INNOTECH je dovoljena šele po tem, ko preberete in so vam jasne vse varnostne opombe in navodila za montažo.

SV – O B S: INNOTECH-produkten får inte användas, förrän säkerhets- och monteringsinstruktionerna har lästs igenom och förstås fullständigt.

TR – DİKKAT: INNOTECH ürününün kullanımına ancak güvenlik uyarıları ve montaj talimatı tamamen okunup anlaşıldıktan sonra izin verilir.

ZH – 注意: 只有在完全阅读并理解安全提示和装配说明书之后,才允许使用INNOTECH产品。





2



3

3



4

4



5

5



5

6



8

7



10

8



13

9



17

10



18

11



19

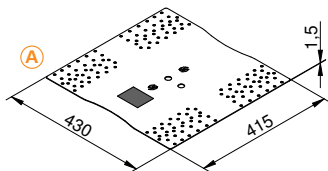
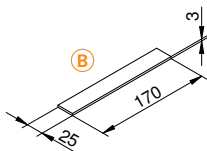

A) 1x | INNOTECH SAND-01

C) 2x | M16 3D DIN9021

B) 4x | 25 x 3, L=170

D) 1x | M16 DIN985

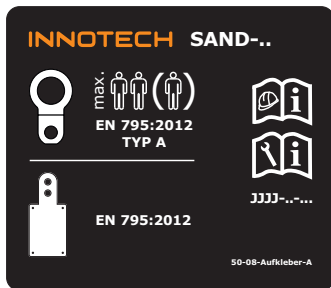



[mm]

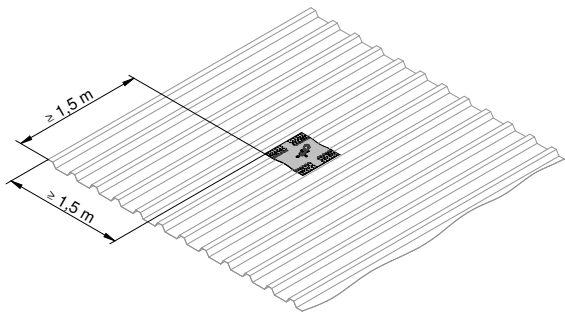
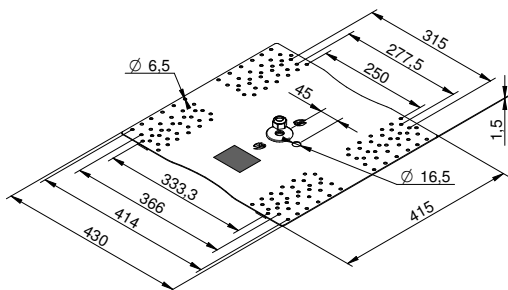

4



[mm]

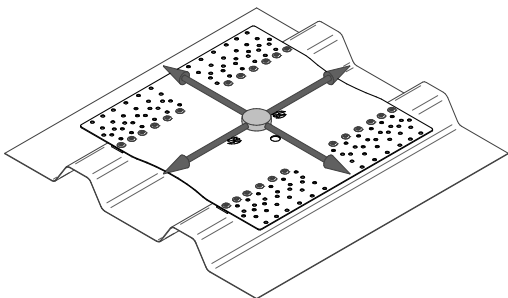

5



[mm]

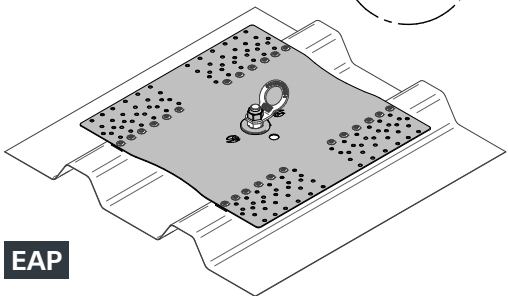
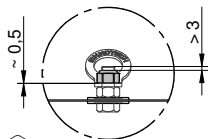

EAP



[mm]

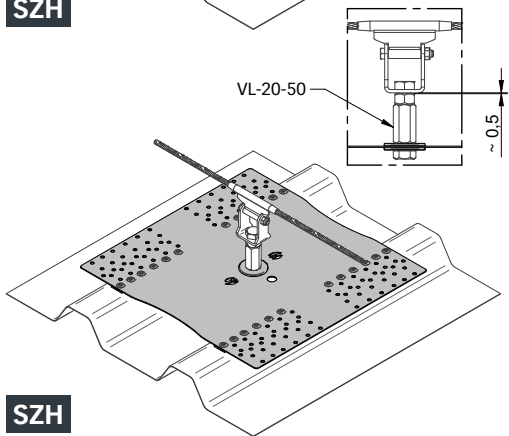
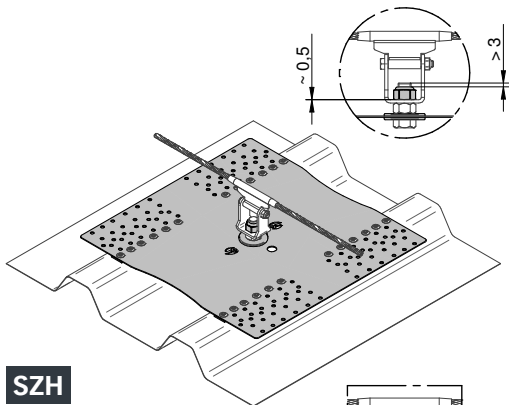



[mm]

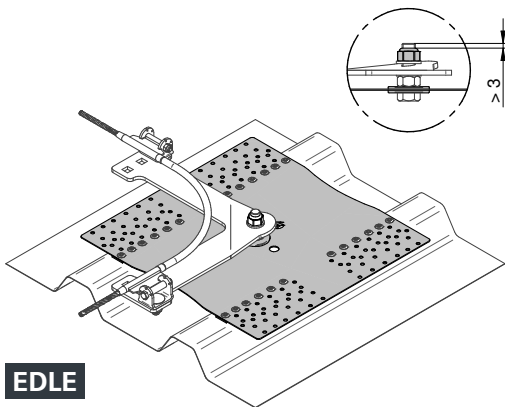
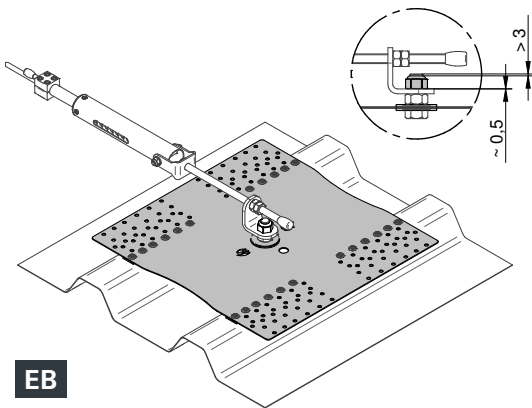



2x



24



[mm]

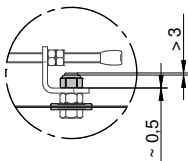
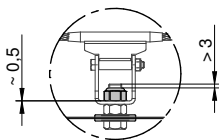
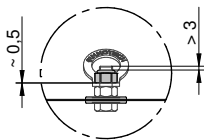
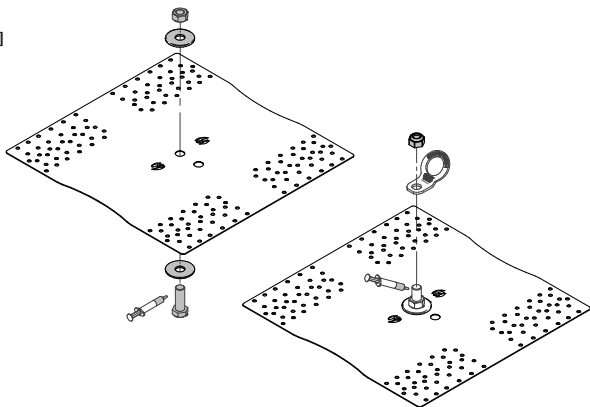



2x



24



[mm]

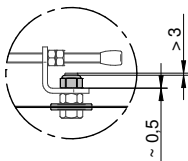
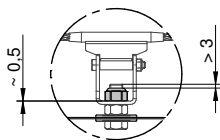
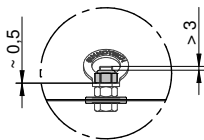
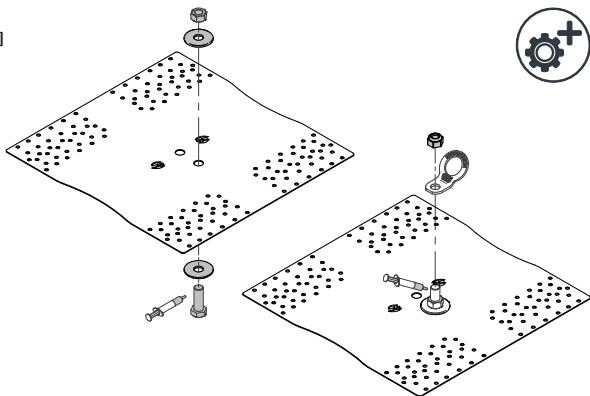

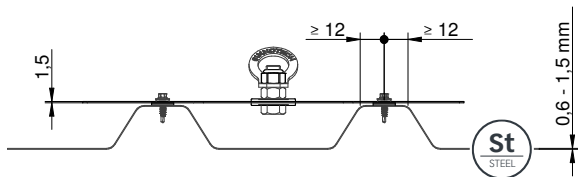

[mm]

 SL3-S-S16 6,0 x 27
 BBF-06.0-027-DS-A2

 SL2-S-S16 6,3 x 28
 BBF-06.3-028-DS-A2

24x

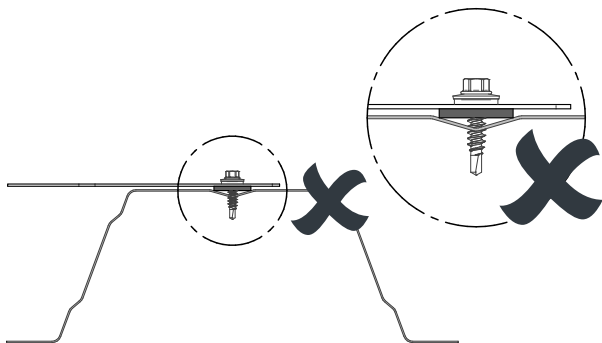
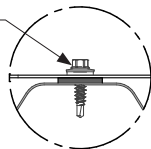



1.

[mm]

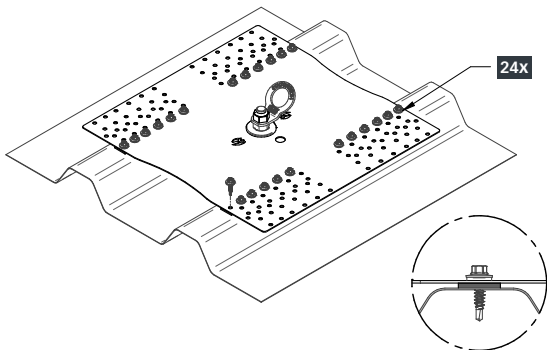
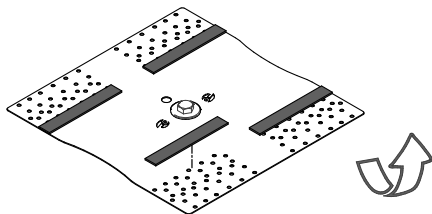
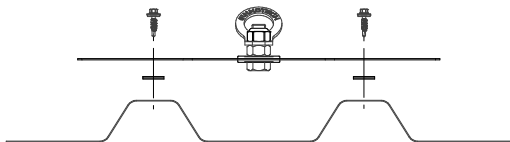



[mm]

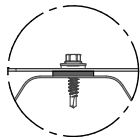
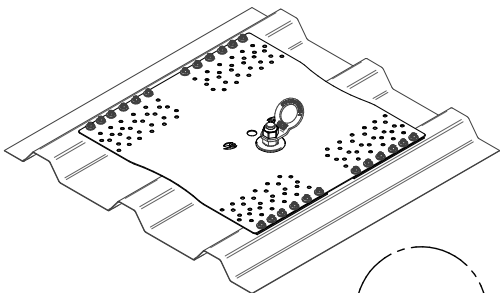
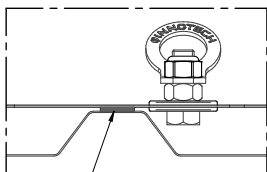
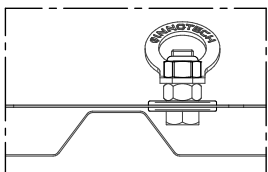
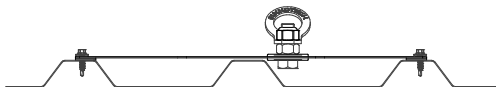

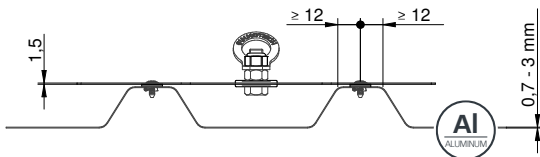

[mm]

 6,3 x 20
 BN-6.3-20.2-0-AL

24x

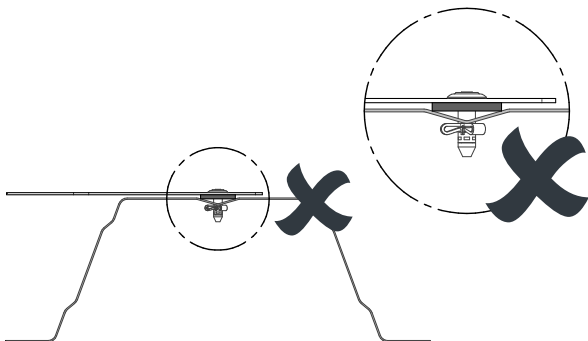
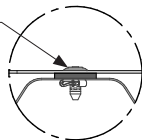



1.

[mm]



Ø 6,5

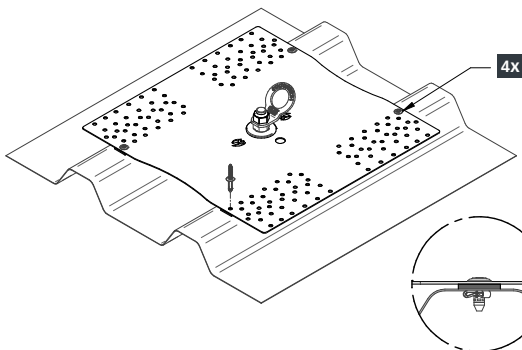
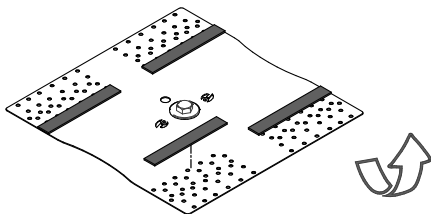
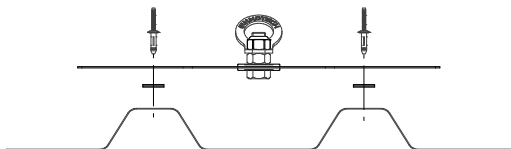

8



2.

[mm]



Ø 6,5

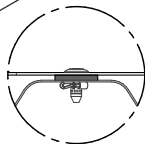
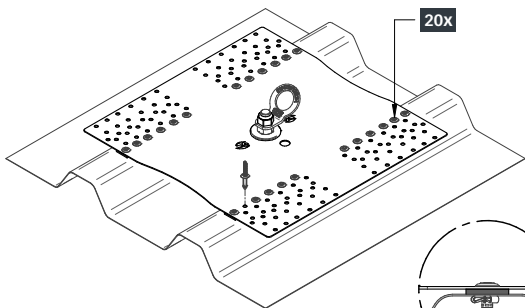
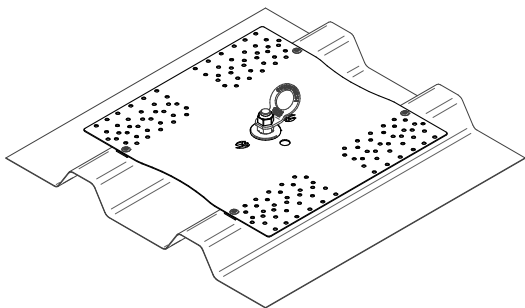



[mm]

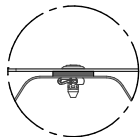
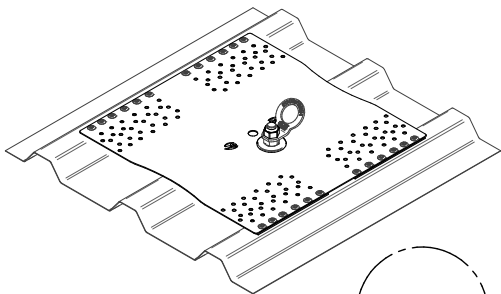
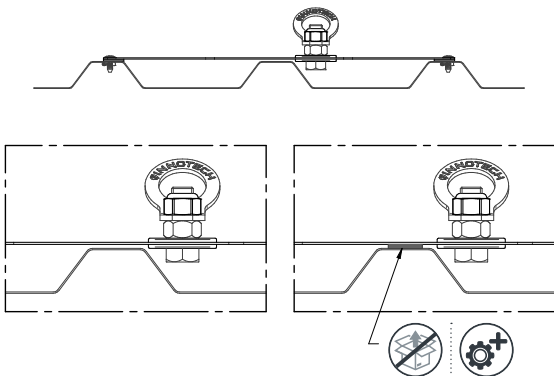

[mm]

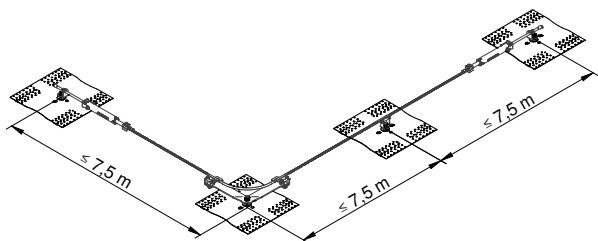
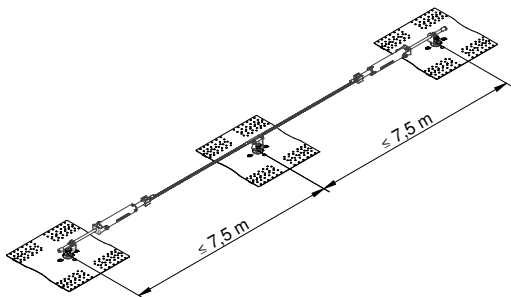

10



[mm]



BEF-309

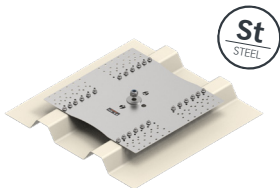

10



[mm]



BEF-306

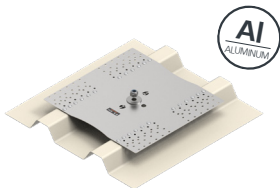

INNOTECH WEB-APP

INNO|doc

Simple. Clear. Document.



www.innotech.at/de/innodoc

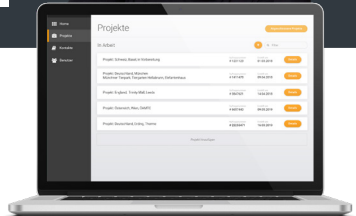

INNOTECH Arbeitsschutz GmbH

Laizing 10, A-4656 Kirchham

T: +43 7619 22122-0

office@innotech.at | www.innotech.at

