

XTIRPA™

**INSTRUCTION AND SAFETY MANUAL FOR
T-SHAPED UNIVERSAL BASE SYSTEM FOR XTIRPA
VEHICLES AND COUNTERBALANCED TRUCKS**

**UNIVERSAL RESCUE SYSTEM
IN-8012**

TO BE READ AND UNDERSTOOD BY USER PRIOR TO EACH USE

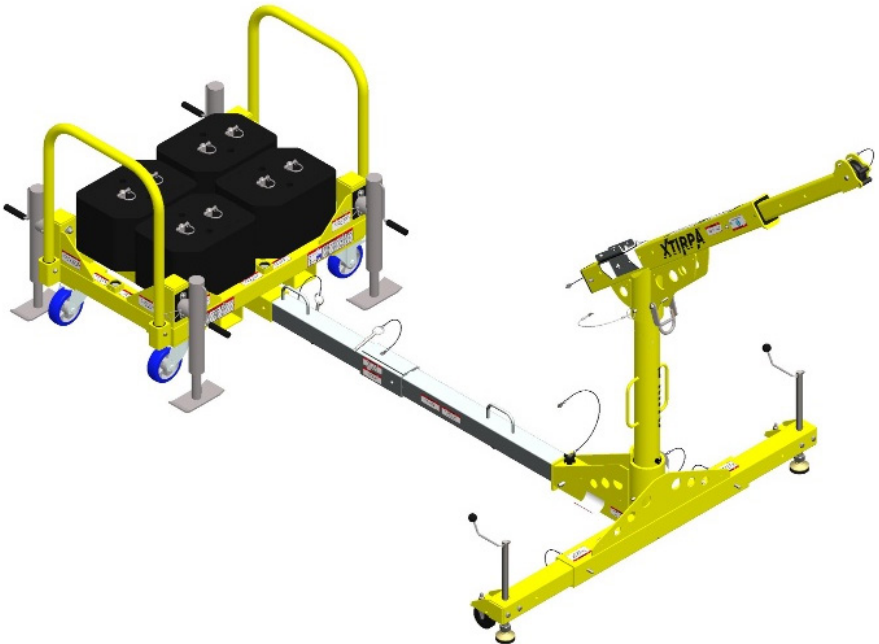

EC DECLARATION OF CONFORMITY (English)

Manufacturer established in the community:

*Produits de Services Publics INNOVA inc.,
1040, boul. Industriel, Granby, Québec, Canada J2J 1A4*

Declares that the following PPE product:

IN-8012 XTIRPA™ Universal T-base system for 102mm (4") mast for PPE

is in conformity with the provisions of the regulation (EU) 2016/425 and complies to the standard:

Personal fall Protection Equipment type B and E EN 795: 2012

is identical to the PPE product which was submitted to the EC Certificate of Conformity no: 0082/1363/160/05/19/0571 and 0082/1363/160/06/19/0615 delivered by:

APAVE SUDEUROPE SAS No 0082
8 rue Jean-Jacques Vernazza
Z.A.C. Saumaty-Séon - BP 193 -
13322 MARSEILLE CEDEX 16 - France

is submitted to the article 19c (module C2) of the regulation (EU) 2016/425, under the supervision of the notified body:

APAVE SUDEUROPE SAS No 0082
8 rue Jean-Jacques Vernazza
Z.A.C. Saumaty-Séon - BP 193 -
13322 MARSEILLE CEDEX 16 – France

Produced at: GRANBY, Québec Canada, July 2nd 2019



Michael Parker
Quality Manager

INTRODUCTION

WARNING

The XTIRPA system is part of a personal protection equipment system for fall protection, work positioning, personnel handling, materials handling, or rescue, for use in confined spaces.

The user must read, understand and follow the Manufacturer's instructions for each component or part of the complete XTIRPA system. These instructions must be provided to the user of the XTIRPA system. The user must read and understand these instructions before using the XTIRPA system. The manufacturer's instructions must be followed for proper use and maintenance of this product. Alterations or misuse of the XTIRPA system or of any component or part thereof or failure to follow instructions may result in serious injury or death, for which the manufacturer disclaims all warranties and liabilities whatsoever, user, owner and purchaser of the XTIRPA system waiving all claims, rights and recourses against the manufacturer and derived therefrom.

The XTIRPA System was designed for persons needing a personal protection equipment system for fall protection, work positioning, personnel handling, materials handling, or rescue, for use in confined spaces. The XTIRPA System is intended to act as a support structure or anchor for these uses. Due to its design and the use of an advanced composite, the XTIRPA System is one of the lightest and most ergonomic systems of its kind on the market. The XTIRPA System is in compliance with ANSI, OSHA, CSST and CE standards. The equipment has been tested in accordance with applicable requirements of the standard EN 795:2012 Type A, Type B as well as Type E and TS16415: 2013.

IMPORTANT: The buyer must complete and return the limited warranty registration form.

Always keep this instruction and safety manual available to any worker needing to use the XTIRPA system.

Before each use, the user must read, understand and follow the manufacturer's instruction and safety manual.

Keep instructional and safety labels affixed to the XTIRPA system and its components and parts clean and legible at all times. Clean or replace if required. New labels can be obtained upon demand.

Establish a regular training program on the XTIRPA system for new & experienced workers, as further recommended in this instruction and safety manual. Establish a detailed inspection program for the XTIRPA system and document findings, as further recommended in this instruction and safety manual. Always inspect the XTIRPA system before each use and at least once a year by a competent person.

The XTIRPA system and its components and parts have labels indicating the maximum capacity of each. Exceeding said maximum capacity may result not only in damages to the XTIRPA system or its components or parts but also in serious injury or death, for which the manufacturer disclaims all warranties and liabilities whatsoever, user, owner and purchaser of the XTIRPA system waiving all claims, rights and recourses against the manufacturer derived therefrom.

The XTIRPA IN-8012 universal safety system, including the following components: IN-2240

(Mast for fall protection and retrieval); IN-2313 (102mm (4'') Mast for Davit-Arm IN-2237 1524mm (60'') height); IN-2426 (Mast for davit arm 30'' to 48'' 500mm (19.7) high); IN-2237 (Extendable davit arm for fall protection and retrieval); IN-2305 (T-shaped universal base for 102mm (4'') mast); A2305-40 (2438mm (96'') extension tube for counterbalanced truck); A2305-07 (Counterbalanced truck); IN-2525 (Fall arrest counterweight cart), a2305-90 (counterweight support), A2305-12 (Anchor adaptor for T-shaped universal base); A2305-20 (63.5-51mm(2.5-2'') coupling reducer for T-shaped base extension); A2305-25 (T-shaped base union for 1829mm (72'') extension); A2305-29 (90-degree extension); A2305-16 (1829mm (72'') extension for 63.5mm(2.5'') T-shaped base coupling); A2305-55 (Adaptor for vehicle coupling); A2305-65 (Ballast support assembly); IN-2517 (Hitch adapter for European Vehicle), complies with document number MU8012-012ENG rev04.

APAVE SUDEUROPE SAS (Headquarters: 8 rue Jean-Jacques Vernazza—Z.A.C. Saumaty-Séon - CS 60193 - 13322 MARSEILLE CEDEX 16) is the notified body involved in the initial production and certification control phase.

DESCRIPTION & INTERPRETATION OF MARKING SYMBOLS



This symbol is used to alert the user to a potential hazard. The safety of the worker is in jeopardy. It is imperative to follow the manufacturer's recommendations.



This symbol asks the user to read and understand the manual for this product before use.



This symbol specifies that the system can be used simultaneously by a maximum of 3 users.



Anchorage hardware must be qualified and experienced personnel. The installer must follow the anchorage hardware manufacturers recommendations at all times.



Periodic inspections of hardware must be done. In the occurrence of a fall or the safety of the equipment is in doubt, equipment must be immediately removed from service and inspected by qualified personnel before reuse.



Maximum permissible arresting force (MAF) .



The positioning pins must always be in place when manoeuvring personnel. Otherwise, serious injuries may occur.



Adaptors are designed to function only with the XTIRPA equipment or approved by the manufacturer.

-1- APPLICATION

The XTIRPA system, and its many components and parts (including davit arm, manhole guard, removable adapter, permanent adapter, integrated mast and side entry cart), are intended to be used as part of a personal protection equipment system for fall protection, work positioning, personnel handling, materials handling, or rescue, for use in confined spaces. The XTIRPA system is intended to act as a support structure or anchor for these uses.

-2- RESTRICTIONS

- a) **CAPACITY:** The maximum working load (CMT) of this product is 360lbs (164kg). According to CE (EN 795: 2012 and TS16415: 2013), use an EN-360 fall arrest system and / or EN-363 or EN-1496 recovery system.
- b) The manufacturer attests that anchoring devices have been tested accordingly to the current European standard (EN 795:2012 Type A, Type B and Type E and et TS16415 : 2013) and, except otherwise stipulated, they are to be used by a single person per anchor point, using a shock absorber in accordance with regulation EN 355.
- c) **PRECAUTIONS:** Take the necessary precautions to limit injuries to the user and risks of damaging the XTIRPA system.
- d) Use of the XTIRPA system in areas where environmental hazards exist may require additional precautions to limit the possibility of injury to the user or damage to the XTIRPA system. Hazards may include, but are not limited to: high heat, fire, flame, smoke, fumes, caustic chemicals, corrosive environments, high voltage power lines, sudden changes of pressure, explosive or toxic gases or substances, water or risks of flooding, risks of wall, ceiling or floor collapsing, moving machinery and sharp edges.

WARNING: The system should be used on a surface that does not contain contamination such as: oil, grease, or other products that could make the system unstable.

WARNING: The a2305-65 equipment should not be used when it freezes or there is a risk of frost.

- e) Install and secure all signaling and other precautionary and security measures, including but not limited to, notifying users, bystanders and vehicle operators circulating near the XTIRPA system of the presence of the XTIRPA system and its workers, before starting work.
- f) Wear all appropriate certified and recommended security equipment such as, but not limited to, hard hat, protective eyewear, leather gloves, protective clothing, work boots, harness in accordance with EN 361, flashlight and respiratory device if needed.

WARNING: Equipment shall not be used past its capacity, or in any other applications for which the equipment was not designed.

WARNING: The equipment should only be used by trained and competent persons to ensure safe use of this product.

- g) Always work in teams of at least two (2) people: 1 attendant and 1 confined space worker (the person attached to the lifeline cable or rope). These people must be qualified and trained on the XTIRPA system. They must have read and understood this instruction and safety manual before using the XTIRPA system. One person works in the confined space (the user attached to the lifeline cable or rope) and the other (attendant) pays out the line and reels it in, keeps in contact with the person inside and remains available in case of any emergency. The attendant makes sure, at all times, that the user who is tying his lifeline cable or rope to his harness is in the right position. The attendant also assures that the XTIRPA system is well in place and that no load imbalance is possible.

IMPORTANT: During installation of the system, it is important to ensure stability throughout.

- h) Use only a certified full body harness in accordance with EN 361 and lifeline cables and ropes for any user of the XTIRPA System, with appropriate specifications designed and recommended for use in specialized work conditions such as those for which the XTIRPA System is intended to be used as per this instruction and safety manual. For the installation of lifeline cables and ropes on the certified 14kn anchor points of the davit arm, see section 6.

IMPORTANT: When used as PPE, the system must be fitted with a device limiting the dynamic forces exerted on the user to a maximum of 6kN (1320 LbF).

- i) Plan your work program before starting. Have the required equipment, procedures and people, which must be qualified and trained on the XTIRPA system and who must have read and understood this instruction and safety manual before using the XTIRPA system, available to do the job.
- j) Keep all instructional and safety labels affixed on the XTIRPA system and its components and parts clean and legible at all times. Clean or replace if required. New labels can be obtained upon demand.

IMPORTANT: If the markings on the anchoring device are not legible after installation, it is recommended that supplementary markings next to the anchoring device be made.

WARNING: No modifications or additions to the equipment shall be performed without the authorization of the manufacturer, and all repairs shall be done as indicated by the operating procedure of the manufacturer.

WARNING: It is established and agreed that the equipment (system) is reserved for the use of three persons maximum.

- k) Do not exceed 360 lbs (164 kg) per anchor, the maximum workload (CMT) of the system.

- l) Follow all applicable laws, regulations and standards for work, entry and exit in confined spaces.
- m) A person who has not read this instruction and safety manual, has not been trained in using the XTIRPA system and does not understand all operation, safety, maintenance, servicing and storage instructions contained in this instruction and safety manual and in any other recommendations provided by the manufacturer or its certified trainers is not qualified to operate the XTIRPA system and does it at their sole risk, therefore waiving any and all claims, rights and recourses against the manufacturer and derived therefrom.
- n) Make sure to conform to relative demands regarding anchoring devices (E.g.: floor adapter, wall adapter, etc.) or ensure that the chosen structure that will be used has an anchoring point, and keep in mind minimal required resistance, equivalency and position.

WARNING: Anchoring devices must be installed only by competent persons or organizations.

- o) The maximum force applied by the system on the structure is a vertical force of 14kN according to EN362, EN795: 2012 CE and TS16415: 2013 on the anchorage to which the system is hooked.

WARNING: The system must be appropriately checked, for example, by calculations or tests.

WARNING: The use of a base, structural anchor or fastener, if one exists, must be taken into account when calculating the amount of force supported by the anchor during strength and integrity testing.

- p) A rescue plan shall be put in place in order to account for all likely emergencies that could occur while working.

WARNING: Any modification or addition to the equipment cannot be done without the prior written consent of the manufacturer, and any repairs must be undertaken in accordance with the manufacturer's procedures.

WARNING: It is established and agreed that the equipment (system) is reserved for the use of three persons maximum.

WARNING: It is important to place the XTIRPA system on a hard and level surface. Do not use the XTIRPA system on a soft surface, including, but not limited to, sand, grass, gravel and rocks. If you have any questions about use or maintenance or whether the XTIRPA system is appropriate for your job, please contact the Manufacturer PSP INNOVA INC.

WARNING: For safety reasons, make sure when using the anti-drop system that you have enough space under the user, so as to avoid injury. If a fall occurs, there should be enough space to avoid a collision with the ground or any obstacle. See the diagram in Section 8 for calculating this distance.

XTIRPA SYSTEM REQUIREMENTS

IMPORTANT: If you have questions on the use, care or suitability of the XTIRPA system for your application, please contact the manufacturer INNOVA Public Utility Products Inc.

IMPORTANT: Record the product identification information from the ID label in the maintenance and inspection log of this instruction and safety manual.

IMPORTANT: Record purchasing date and also date of first use on the maintenance and inspection log sheet included in this safety instruction manual.

IMPORTANT: In the event that a handling/positioning hoist is required, this option is offered to you with the addition of an adaptor located at the bottom of the davit arm. Installation steps 10, 11 and 12 for the lifeline/hoist will need to be repeated. If you have questions regarding the use, maintenance or appropriateness of the XTIRPA system for your application, please contact the manufacturer PSP INNOVA INC.

- a) The XTIRPA system is intended to be used as part of a personal protection equipment system for fall protection, work positioning, personnel handling, materials handling, or rescue, for use in confined spaces. The XTIRPA system is intended to act as a support structure or anchor for these uses. The XTIRPA system must be used only with adapters, anchors, connectors (EN 362), and other components, parts or subsystems that have been certified, approved and recommended by the manufacturer.

WARNING: This system should never be used to transport persons and material at the same time.

- b) Substitutions or replacements made with non-approved adapters, anchors, connectors (EN 362), other components, parts or subsystems may be incompatible, may jeopardize the safety and reliability of the complete XTIRPA system and may result in serious injury or death, for which the manufacturer disclaims all warranties and liabilities whatsoever, user, owner and purchaser of the XTIRPA system waiving all claims, rights and recourses against the manufacturer derived therefrom.
- c) Connectors (EN 362) (hooks, carabiners, D-rings) must comply with EN362.
- d) Make sure the lifeline cable or rope is positioned directly over the work area. Use only certified lifeline cable or rope, in perfect working condition, with appropriate specifications, including maximum leverage capabilities, for the intended use of the XTIRPA system.
- e) Owners must make sure that, before each use, all users of the XTIRPA system have read, understood and follow the Manufacturer's Instructions and safety manual.
- f) Owners must also make sure that all users have successfully been trained in using the XTIRPA system, before allowing them to use the XTIRPA system, and at least annually thereafter.

IMPORTANT: When used, the expandable coupling system for XTIRPA vehicles and counterbalanced trucks must be lifted using the adjustable supporting legs. The transport wheels must not be in contact with the ground.

- g) A person who has not read the Instruction and safety manual, has not been trained in using the XTIRPA system and does not understand all operation and safety instructions, is not qualified to operate the XTIRPA system. An untrained user exposes himself and others to possible serious injury or death, for which the manufacturer disclaims all warranties and liabilities whatsoever, user, owner and purchaser of the XTIRPA system waiving all claims, rights and recourses against the manufacturer derived therefrom.
- h) Refer to and follow all EN standards or other local standards and regulations. Observe all the requirements of your local regulations for your applications.
- i) See other important operation instruction and safety information contained hereafter in this instruction and safety manual.
- j) It is imperative to supply all information in sufficient quantity to assure that different equipment articles are compatible when assembled as a system.

WARNING: It is possible that a hazard may occur while using multiple components, as one of them could affect the safety function of the system, if the safety function of one component can be affected by that of another component.

WARNING: It is essential for the safety of the user, if the product is resold to a destination outside the first country, that the reseller supplies the instruction manual, maintenance instruction log sheet for the periodic inspections and all associated repair instructions written in the native language of the country in which the product will be used. It is also required to supply all specific additional information for the equipment.

WARNING: Any persons with a medical condition which could cause a hazard to the user during normal operation and in emergency situations should avoid using the system.

- k) Life expectancy of the XTIRPA system and its components will be determined based on the conclusions of periodic and monthly inspections which will determine whether or not the product may remain in service.

WARNING: It is likely that a danger may arise when using several articles in which the security function of one of the articles is affected by the security function of another article or interferes with it.

WARNING: It is essential for the safety of the user, if the product is resold outside the first country of destination, that the reseller provides the user manual, the instructions for maintenance, for the periodic examinations as well as the instructions relating to repairs, written in the language of the country in which the product is used. Any additional required equipment specific information should also be provided.

WARNING: Anyone with medical conditions that could affect user safety during normal use of the equipment and in an emergency should refrain from using the system.

IMPORTANT: Record the date of purchase as well as the date of first use on the maintenance and inspection sheet contained in this instruction and safety manual.

WARNING: If the system has been used to stop a fall, it should not be used again until a competent person has, in writing, authorized its reuse.

WARNING: The safety of the user is in direct relation to the quality of maintenance and integrity of the equipment.

i) Always use a bubble level to make sure the system is level.

WARNING: When using a counterbalanced truck, all the instructions regarding the weights required for specific applications must be followed. (see table below)

!
WARNING
!

82305-006 RevB

Davit maximum Reach	Center of Mast To center of Trolley	Total Weight Required	Number of 50lb (20Kg) Weights
A inches (mm)	B inches (mm)	W lb (Kg)	
24 (610)	64 (1626)	1500 (682)	30
24 (610)	79 (2007)	1200 (546)	24
24 (610)	133 (3378)	800 (364)	16
48 (1219)	96 (2438)	2000 (909)	40

MAINTENANCE, SERVICING, STORAGE

- a) Before each use, the user must read and understand the Manufacturer's Instruction and safety manual. Ensure that the markings are visible at all times.
- b) Before each use, carefully inspect the XTIRPA system and all components and parts thereof. Any defective parts or components could result in serious injury or death.
- c) The standards require a regular inspection program for all confined space entry / retrieval equipment, as well as maintaining documented results of these inspections. Use the maintenance and inspection sheets included in this Instruction and Safety Manual to document your results.
- d) It is recommended that the anchoring device be marked with the most recent or next inspection date.
- e) Remove the XTIRPA system from service if a problem or an unsafe or defective condition is found during the inspection. Return to an authorized service center or the manufacturer for service.
- f) Replacement components and parts and additional maintenance and servicing procedures must be completed by an authorized service center which has been approved by the manufacturer, or by the manufacturer itself.
- g) If the adjustable supporting legs of the expandable coupling system for XTIRPA vehicles and counterbalanced trucks do not move freely, they must be lubricated with a light machine oil.
- h) Establish a monthly inspection which should be done by a competent person (person who is familiar, has been trained and has read and fully understands this instruction and safety manual), other than the user.

WARNING: A periodic inspection should be performed at least once every twelve months.

- i) Periodically clean the exterior of the system using water and mild detergent. Clean labels as required.
- j) When lowering the removable systems, it is important to slowly place the system on the ground, to avoid damaging components.
- k) Store the XTIRPA system in a clean and dry environment, out of direct sunlight. Avoid areas with chemical or toxic vapors, substances or environments. Do not immerse or leave in direct contact with water, as corrosion and rust may occur. Inspect the XTIRPA system after any period of extended storage and at least once a month.
- l) The XTIRPA system and its components was designed for 10 years of continuous service. The life expectancy of the XTIRPA system and its components will be determined after periodic and monthly inspections that will determine whether or not the product may remain in service.
- m) All components and parts of the XTIRPA system should be stored in separate bags to facilitate transport and handling.

WARRANTY

The XTIRPA system offered by the Manufacturer, INNOVA Public Utility Products Inc., is warranted against manufacturing defects in workmanship and materials for a period of two (2) years from the date of shipment of the product, which warranty only covers the original purchaser of the XTIRPA system. The Manufacturer will promptly repair or replace all components or parts found to be defective, the Manufacturer reserving the right to elect to have any alleged defective part returned to its plant for inspection before making a repair or replacement.

Only components or parts found to be defective by the Manufacturer, at its sole discretion and upon any inspection requested and performed by the Manufacturer, will either be repaired or replaced by the Manufacturer, at its sole choice.

All claims must be forwarded in writing to the Manufacturer, immediately upon discovery by owner, and must be accompanied by a copy of the proof of purchase of the original purchaser. Manufacturer will issue a claim's number and give specific instructions to be followed as to claim's procedures and return of the defective part, if so requested by the Manufacturer. Owner will collaborate with Manufacturer and its representatives to allow inspection of any alleged defective part. All shipping costs to return defective components and parts to the Manufacturer's plant are payable by owner, the cost of reshipping replacement components or parts being covered by the Manufacturer.

This warranty does not cover equipment damages resulting from any other cause than a manufacturing defect in workmanship or materials, including, without limitation, damages resulting from abuse, lack of maintenance, improper handling or storage, voluntary damages, vandalism, accidental damages or damages resulting from impact or collision, damage in transit, damages caused by fire, explosion, chemical, toxic or corrosive vapors, substances or environments, water, normal corrosion and rust, storms, hail, and other acts of God, war insurrection, acts of terrorism or other damage beyond the control of the Manufacturer. This warranty applies only to the original purchaser and is the only one applicable to the XTIRPA system, and is in lieu of all other warranties, expressed or implied. Without limiting the generality of the foregoing, the Manufacturer will not be liable nor responsible for any other cost, damages or claims whatsoever, including for any special, incidental, indirect, or consequential damages whatsoever such as, but not limited to, damages for loss of profits or expected revenues, for business interruption, for personal injury, for failure to meet any duty including of good faith or of reasonable care, for negligence, and for any other pecuniary or other loss whatsoever, arising out of or in any way related to the use of or inability to use the XTIRPA system, even in the event of the fault, tort (including negligence), strict liability, breach of contract or breach of warranty, even if the Manufacturer has been advised of the possibility of such damages. The Manufacturer hereby disclaims all other warranties and conditions, either express, implied or statutory, including, but not limited to, any implied warranties or conditions of merchantability, of fitness for a particular purpose or application, and of lack of negligence or lack of workmanlike effort.

IMPORTANT: The buyer must fill out and return the Limited Warranty registration form for each product.

XTIRPA SYSTEM DESCRIPTION

WARNING

The XTIRPA system is part of a personal fall arrest, work positioning, personnel handling, material handling or rescue system for use in confined spaces. The XTIRPA system is intended to act as a support structure or anchor for these uses. The user must read, understand and follow the manufacturer's instructions for each component or part of the complete XTIRPA system. These instructions must be provided to the user of the XTIRPA system. The user must read and understand these instructions before using the XTIRPA system. The manufacturer's instructions must be followed for proper use and maintenance of the XTIRPA system. Alterations or misuse of the XTIRPA system or failure to follow instructions may result in serious injury or death, for which the Manufacturer disclaims all warranties and liabilities whatsoever, user, owner and purchaser of the XTIRPA system waiving all claims, rights and recourses against the manufacturer and derived therefrom.

DESCRIPTIONS:

- 762mm-1219mm (30" - 48") EXTENDABLE DAVIT ARM: IN-2237 (see illustration 1)
- 102mm (4") MAST FOR IN-2237 DAVIT ARM, 1067mm (42") HEIGHT: IN-2240 (see illustration 2)
- T-SHAPED UNIVERSAL BASE SYSTEM FOR 102mm (4") MAST: IN-2305 (see illustration 3)
- 2438mm (96") EXTENSION TUBE FOR COUNTERBALANCED TRUCK: A2305-40 (see illustration 4)
- COUNTERBALANCED TRUCK: A2305-07 (see illustration 5)
- T-SHAPED BASE UNION FOR 1829MM (72") EXTENSION: A2305-25 (see illustration 6)
- ANCHOR ADAPTOR FOR T-SHAPED UNIVERSAL BASE: A2305-12 (see illustration 7)
- BALLAST SUPPORT ASSEMBLY: A2305-65 (see illustration 8)
- 1829MM (72") EXTENSION FOR 63.5MM(2.5") T-SHAPED BASE COUPLING: A2305-16 (illustration 9)
- 90-DEGREE EXTENSION: A2305-29 (see illustration 10)
- T-SHAPED UNIVERSAL BASE SYSTEM FOR VEHICLES AND COUNTERBALANCED TRUCKS (A2305-07): IN-8012 (see illustration 11)
- T-SHAPED UNIVERSAL BASE SYSTEM FOR VEHICLES AND ANCHOR ADAPTOR FOR T-SHAPED UNIVERSAL BASE (A2305-12): IN-8012 (see illustration 12)
- T-SHAPED UNIVERSAL BASE SYSTEM FOR VEHICLES AND ADAPTOR BALLAST SUPPORT ASSEMBLY (A2305-65): IN-8012 (see illustration 13)
- T-SHAPED UNIVERSAL BASE SYSTEM FOR VEHICLES AND 1829MM (72") EXTENSION FOR 63.5MM(2.5") T-SHAPED BASE COUPLING (A2305-16): IN-8012 (see illustration 14)
- T-SHAPED UNIVERSAL BASE SYSTEM FOR VEHICLES AND ADAPTOR 90-DEGREE EXTENSION (A2305-29): IN-8012 (see illustration 15)
- 63.5-51MM(2.5-2") COUPLING REDUCER FOR T-SHAPED BASE EXTENSION: A2305-20 (see illustration 16)
- VEHICLE COUPLING ADAPTOR: A2305-55 (see illustration 17)
- HITCH ADAPTER FOR EUROPEAN VEHICLE: IN-2517 (see illustration 18)

- 102MM (4") MAST FOR DAVIT-ARM IN-2237 1524MM (60") HEIGHT: IN-2313 (see illustration 19)
- MAST FOR DAVIT ARM 30" TO 48" 500MM (19.7) HIGH: IN-2426 (see illustration 20)
- FALL PROTECTION TRUCK: IN-2525 (illustration 21)
- COUNTERWEIGHT SUPPORT: a2305-90 (illustration 22)

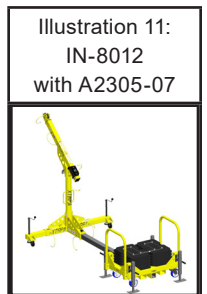
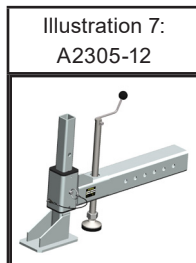
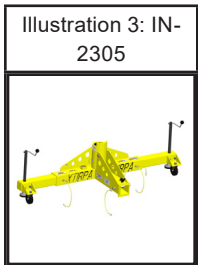
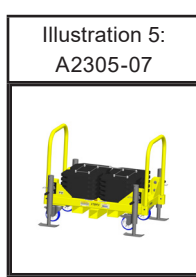
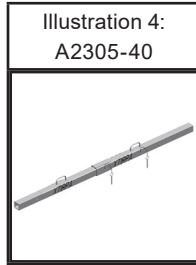

Illustration 12:
IN-8012
with A2305-12



Illustration 16:
A2305-20



Illustration 20:
IN-2426



Illustration 13:
IN-8012
with A2305-65

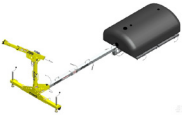

Illustration 17:
A2305-55



Illustration 21:
IN-2525



Illustration 14:
IN-8012
with A2305-16



Illustration 18:
IN-2517

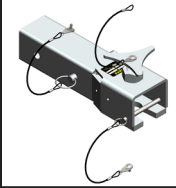

Illustration 22:
A2305-90



Illustration 15:
IN-8012
with A2305-29



Illustration 19:
IN-2313

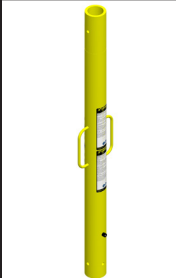

TYPE A MOUNTING COMPATIBILITY

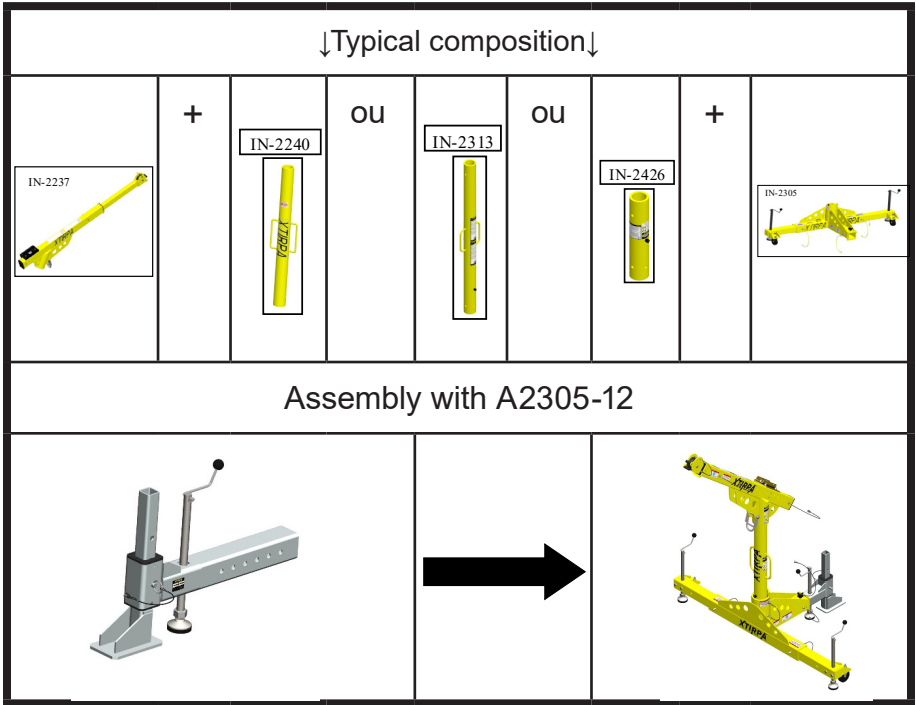

TYPE B MOUNTING COMPATIBILITY

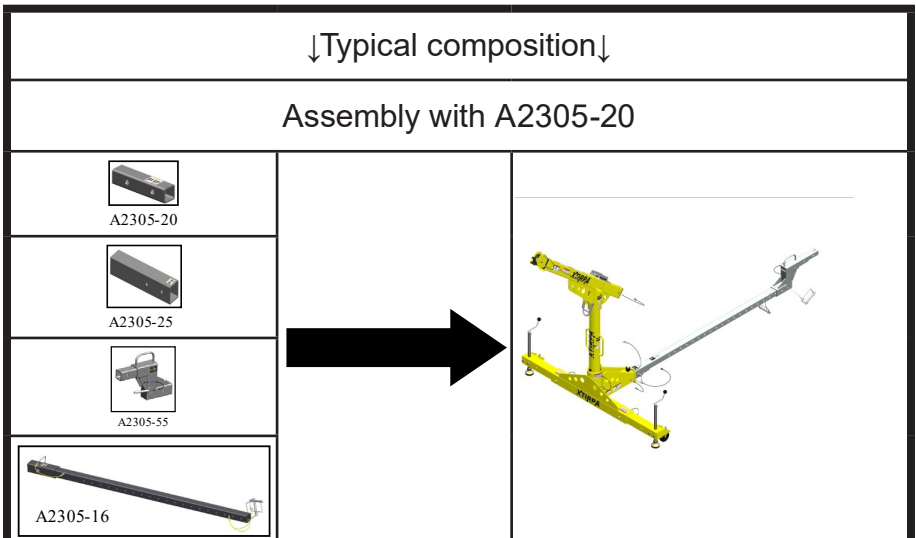

Assembly with A2305-20



A2305-20



A2305-25



A2305-55



A2305-29



Installation with IN-2517



IN-2517



A2305-25



A2305-55



A2305-16

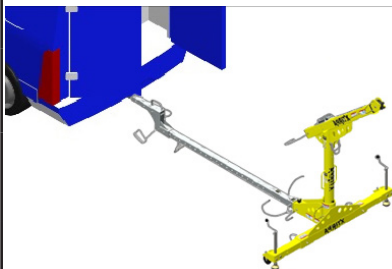

Installation with IN-2517



IN-2517



A2305-25



A2305-55



A2305-29

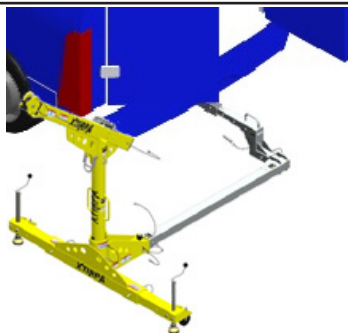

TYPE E MOUNTING COMPATIBILITY

↓Typical composition↓

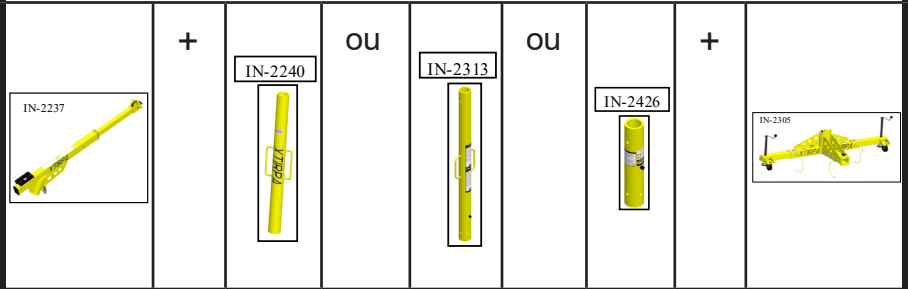

Assembly with A2305-07

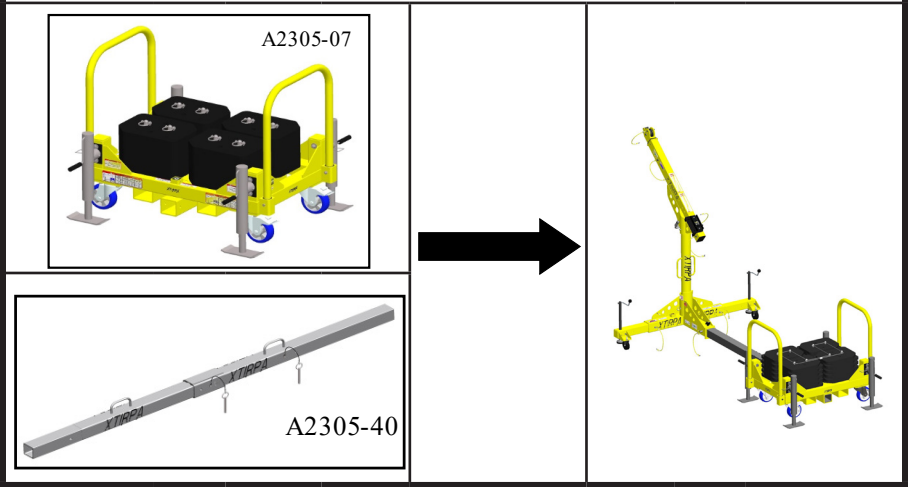

Installation with IN-2525

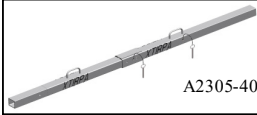

A2305-40

↓Typical composition (continued)↓



+



OU

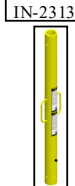

OU



+

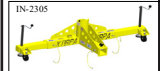

+

Assembly with A2305-90

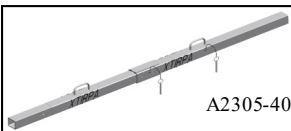
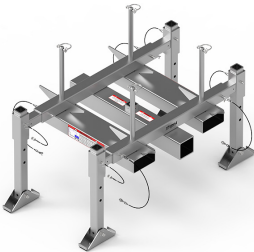

A2305-40

Assembly with A2305-65

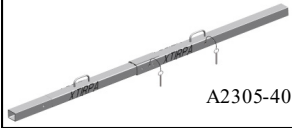
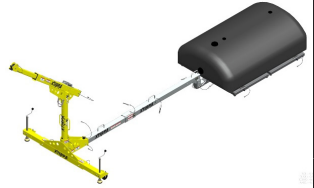

OPERATION, ASSEMBLY AND USE XTIR-PA SYSTEM

WARNING: The XTIRPA system is part of a personal fall arrest, work positioning, personnel handling, material handling or rescue system for use in confined spaces. The XTIRPA system is intended to act as a support structure or anchor for these uses. The user must read, understand and follow the manufacturer's instructions for each component or part of the complete XTIRPA system.

WARNING: These instructions must be provided to the user of the XTIRPA system. The user must read and understand these instructions before using the XTIRPA system. The manufacturer's instructions must be followed for proper use and maintenance of the XTIRPA system. Alterations or misuse of the XTIRPA system or failure to follow instructions may result in serious injury or death, for which the Manufacturer disclaims all warranties and liabilities whatsoever, user, owner and purchaser of the XTIRPA system waiving all claims, rights and recourses against the manufacturer and derived therefrom.

IMPORTANT: If you have questions on the use, care or suitability of the XTIRPA system for your application, please contact the manufacturer INNOVA Public Utility Products Inc.

IMPORTANT: Record the product identification information from the ID label in the maintenance and inspection log of this instruction and safety manual.

OPERATION AND INSTALLATION OF THE T-BASED SYSTEM WITH THE COUNTER-WEIGHT TROLLEY (A2305-07)

1. Make sure that all components and parts are in perfect working order and that everything is working properly.



2. Determine the location of the cart.

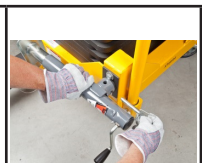

3. Remove the pins from the leveling cylinders and rotate the latter to the vertical position.



4. Adjust the leveling cylinders.



5. Use the level bubble and make sure that it is in the center of the indicator dial.



WARNING: When in use, it is imperative that the counterweight cart is lifted so that the wheels are not in contact with the ground, only the leveling cylinders.

6. Insert the extension tube and lock with the pin.

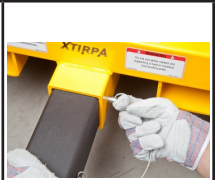

7. Insert the extension tube into the universal base for T-mast.



8. Lock the tube with the pin.

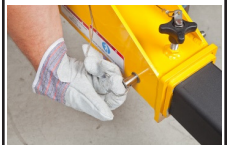

9. Make sure the locking handle is securely screwed in place.



10. Level the system.

OPERATION AND INSTALLATION OF THE T-BASED SYSTEM WITH THE COUNTER-WEIGHT TROLLEY (IN-2525)

1. Make sure that all components and pieces are in perfect working condition and that everything is functioning correctly.

2. Determine the placement of the truck.



3. Remove the pins from the level adjustment screws and rotate them to a vertical position.



4. Tighten the level adjustment screws.



5. Use a bubble level and make sure that the bubble is in the center of the indicator.



WARNING: When used, the counterbalanced truck must be lifted so that the wheels do not come into contact with the ground, only the level adjustment screws.

- 6.** Insert extension tube and lock with pin.



- 7.** Insert extension tube into T-shaped universal base.



- 8.** Lock tube with pin.

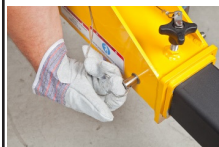

- 9.** Make sure that the locking handle is firmly screwed in place.



- 10.** Level the system.

OPERATION AND INSTALLATION OF THE T-BASED SYSTEM WITH THE COUNTER-WEIGHT TROLLEY (A2305-90)

- 1.** Make sure that all components and parts are in perfect working order and that everything is working properly.

2. Determine the location of the cart.



3. Remove the pins from the legs to adjust the leveling of the carriage.

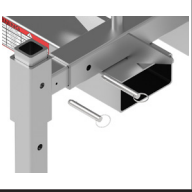

4. Use the level bubble and make sure that it is in the center of the indicator dial.



5. Insert the extension tube and lock with the pin.

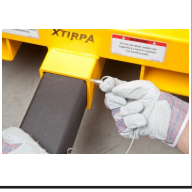

6. Insert the extension tube into the universal base for T-mast.



7. Lock the tube with the pin.



8. Make sure the locking handle is securely screwed in place.



- 9.** Level the system.

OPERATION AND INSTALLATION OF T-SHAPED BASE SYSTEM WITH BALLAST (A2305-65)

- 1.** Make sure that all components and pieces are in perfect working condition and that everything is functioning correctly.

- 2.** A. Assemble the two parts of the tank platform.
3. B. Attach the two parts of the platform with pin

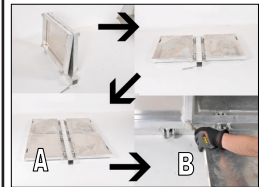

- 4.** Attach the water tank with the 4 pins situated on the edges of the platform.



- 5.** Insert the elbow on the front part of the platform.



- 6.** Lock with the pin.

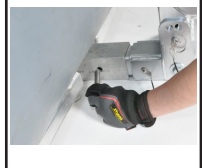

- 7.** If necessary, adjust the angle 0 or +/- 5 degrees.



- 8.** Lock the angle with the pin.

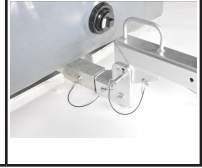

OPERATION AND INSTALLATION OF T-SHAPED BASE SYSTEM FOR BALLAST SUPPORT ASSEMBLY (A2305-65) (cont.)

- 1.** Insert the first part of the extension tube (A2305-40) into the adaptor on the platform and lock with the pin.



- 2.** Add the second part of the extension tube (A2305-40) to the first and lock with the pin.



- 3.** Insert the extension tube into the T-shaped universal base.



- 4.** Lock tube with the pin.

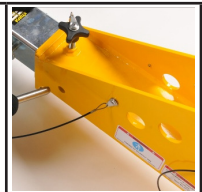

- 5.** Make sure that the locking handle is screwed firmly in place.

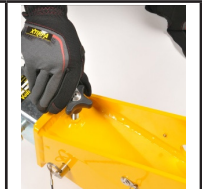

- 6.** Level the system.

OPERATION AND INSTALLATION OF T-SHAPED BASE WITH ANCHORING ADAPTOR FOR T-SHAPED UNIVERSAL BASE (A2305-12)

1. Make sure that all components and parts are in perfect working condition and that they are all functioning properly.

2. Insert anchoring adaptor for T-shaped universal base (A2305-12) into T-shaped universal base.



3. Lock tube with the pin.



4. Make sure locking handle is screwed firmly in place.



5. Attach the anchoring adaptor for the T-shaped universal base (A2305-12) to the floor. If necessary, adjust the height of the movable part of the adaptor with the adjustment screw to level the system.













6. After adjusting the height, lock with the pin.

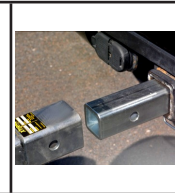
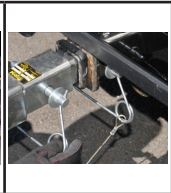

OPERATION AND INSTALLATION OF T-SHAPED BASE WITH 1829MM (72") EXTENSION FOR 63.5MM (2.5") T-SHAPED BASE COUPLING (A2305-16)

1. Make sure that all components and parts are in perfect working condition and that they are all functioning properly.

<p>2. Assemble the 1829mm (72") extension for 63.5mm(2.5") T-shaped base coupling (A2305-16) to T-shaped base union with 1829mm (72") extension (A2305-25) and lock with the pin.</p>		
<p>3. Assemble the 1829mm (72") extension for 63.5mm (2.5") T-shaped base coupling (A2305-16) with 63.5-51mm(2.5-2") coupling reducer for T-shaped base (A2305-20) and lock with pin.</p>		
<p>4. Insert 63.5-51mm (2.5-2") coupling reducer for T-shaped base extension (A2305-20) into vehicle hitch and lock with coupling pin.</p>		
<p>5. Installation of A2305-55 if necessary Insert 63.5-51mm (2.5-2") coupling reducer for T-shaped base extension (A2305-20) into vehicle hitch and lock with coupling pin.</p>		
<p>6. If necessary, insert vehicle coupling adapter (A2305-55) into previously installed A2305-20 and lock with pin.</p>		
<p>7. Insert 1829mm (72") extension for 63.5mm(2.5") T-shaped base coupling (A2305-16) into previously installed A2305-55 and lock with pin.</p>		
<p>8. Insert base union for 1829mm (72") extension (A2305-25) into T-shaped universal base.</p>		

- 9.** Lock tube with pin.

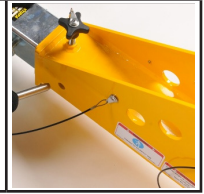

- 10.** Make sure that the locking handle is firmly screwed in place.



- 11.** Level the system.

OPERATION AND INSTALLATION OF T-SHAPED UNIVERSAL BASE SYSTEM WITH 90-DEGREE EXTENSION ADAPTOR (A2305-29)

- 1.** Make sure that all components and parts are in perfect working condition and that they are all functioning properly.

- 2.** Assemble 90-degree extension (A2305-29) to T-shaped base union for (72") extension (A2305-25) and lock with pin.





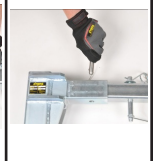

- 3.** Insert 90-degree extension (A2305-29) into previously installed A2305-20 and lock with pin.

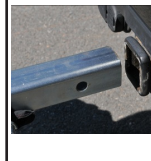

- 4.** Insert 63.5-51mm(2.5-2") coupling reducer for T-shaped base extension (A2305-20) into vehicle hitch and lock with coupling pin.



<p>5. Installation of A2305-55 (if necessary). Insert 63.5-51mm coupling reducer (2.5-2") for T-shaped base extension (A2305-20) into vehicle hitch and lock with coupling pin.</p>		
--	---	---

<p>6. If necessary, insert vehicle coupling adapter (A2305-55) into previously installed A2305-20 and lock with pin.</p>		
---	---	---

<p>7. Insert 90 degree extension (A2305-29) into previously installed A2305-55 and lock with pin.</p>
--

<p>8. Insert T-shaped base union for 1829mm (72") extension (A2305-25) into T-shaped universal base.</p>	
---	---

<p>9. Lock tube with pin.</p>	
--------------------------------------	--

<p>10. Make sure the locking handle is screwed firmly into place.</p>	
--	---

<p>11. Level the system.</p>

OPERATION AND TYPICAL INSTALLATION OF T-SHAPED BASE SYSTEM CONSISTING OF T-SHAPED UNIVERSAL BASE, MAST, AND DAVIT ARM

- 1.** If necessary, adjust base length using existing holes.



- 2.** Adjust to the desired length and lock the two sides to the universal T-shaped base with mast using locking pins.



- 3.** Stabilize the system using the adjustable support legs.



- 4.** When raising, make sure that the wheels do not touch the ground, only the adjustable support legs.



- 5.** Use a level and make sure that the bubble is in the center of the indicator.



- 6.** Insert mast into the receptacle in the universal T-shaped base.



- 7.** Lock with pin.

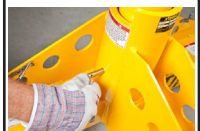

8. Install davit arm receptacle on mast.

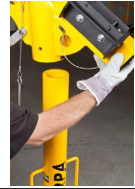

9. Lock with pin.



10. Install lifeline or winch on the davit arm bracket designed for this type of equipment. Use provided locking pin on the lifeline or winch bracket and lock everything with it.



11. A second lifeline or winch can be installed on the jib. Install the lifeline or additional winch on the support of the jib designed to receive this type of equipment. Use the locking pin supplied with the lifeline or winch support and lock everything with the latter.



12. A third lifeline can be installed on the gray "D" anchor point.

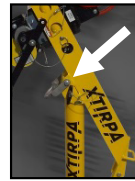

13. Remove retaining pin. Pass lifeline cable or winch through one of the pullies on the end of the davit arm. Make sure the cable or cord has securely been threaded through and that it is firmly in place.



14. Replace retaining pin.



15. Remove locking pin from its place in the center of the davit arm.



16. Extend davit arm to desired length and lock with pin.



IMPORTANT: In the event that a handling/positioning hoist is required, this option is offered to you with the addition of an adaptor located at the bottom of the davit arm. Installation steps 10, 11, and 12 for the safety line/hoist will need to be repeated. If you have questions regarding the use, maintenance or appropriateness of the XTIRPA system for your application, please contact the manufacturer PSP INNOVA INC.

WARNING: Only adaptors and brackets that are approved, certified and recommended by the manufacturer are to be used with the XTIRPA system.

IMPORTANT: If necessary, secure the work area with a manhole guard to prevent falls.

IMPORTANT: Make sure that the lifeline cable or rope is directly positioned above the working area. Only use certified lifeline cables or ropes in perfect condition, that have the appropriate specifications, including maximum lifting capacity, for the intended use of the XTIRPA system.

WARNING: It is important to place the XTIRPA system on a hard and level surface. Do not use the XTIRPA system on a soft surface, including, but not limited to, sand, grass, gravel and rocks. If you have any questions about the use or maintenance or whether the XTIRPA system is appropriate for your job, please contact the Manufacturer PSP INNOVA INC.

WARNING: Any system must be immediately removed from circulation if its safety is questioned, or if it was used to stop a fall. It is imperative not to use the system before a competent person authorizes in writing the integrity of the product before its reuse.

WARNING: For all fall protection devices, it is essential, for safety purposes, that anchoring device is always positioned correctly and that the task to be performed should be done in a manner to reduce risk of fall and height of fall. The anchoring point and fall protection device must be placed directly over the user's position.

WARNING: With the use of a fall protection device, it is essential for safety purposes, to verify the free space required under the user at the work site before each use to avoid and prevent falls, to avoid collision with ground or any other obstacle that could be in the path of the fall.

IMPORTANT: A harness in accordance with EN 361 is the only body support device allowed to be used for fall protection.

IMPORTANT: The harness in accordance with EN 361 must be connected to the system cable or life line rope by the anchoring point of the EN 361-compliant harness..

WARNING: When using a counterbalanced truck, all the instructions regarding the weights required for specific applications must be followed (see table below).

⚠
WARNING
⚠

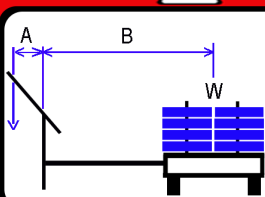

s2305-006 RevB

Davit maximum Reach	Center of Mast To center of Trolley	Total Weight Required	Number of 50lb (20Kg) Weights
A inches (mm)	B inches (mm)	W lb (Kg)	
24 (610)	64 (1626)	1500 (682)	30
24 (610)	79 (2007)	1200 (546)	24
24 (610)	133 (3378)	800 (364)	16
48 (1219)	96 (2438)	2000 (909)	40

WARNING: It should be noted that only those 22.7 kg (50 lbs) P2305-016N plates which were certified, approved and recommended by the manufacturer can be used.

WARNING: The total weight required for the maximum reach of the davit arm must be respected and a locking system of counterbalance should be in place.

WARNING: The instruction and safety manual must be followed for proper use and maintenance of this product. Alterations or misuse of the XTIRPA system or of any component or part thereof or failure to follow instructions may result in serious injury or death, for which the manufacturer disclaims all warranties and liabilities whatsoever, user, owner and purchaser of the XTIRPA system waiving all claims, rights and recourses against the manufacturer and derived therefrom.

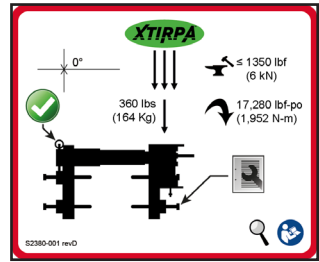
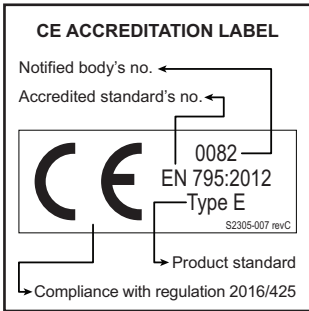

Products manufactured by:
Innova Public Utility Products inc.
1040 boul. Industriel, Granby, QC, Canada J2J 1A4
www.xtirpa.com

XTIRPA[®] IN-2426 Mast

Standards:
Meets CE standards
EN 795:2012 and TS 16415:2013

Maximum Working Load:
360 lb (164 kg)

Materials:
Aluminum, Stainless Steel

Inspection :
Before each use, inspect the XTIRPA system to determine that it is in perfect working condition.
At least once a month, the portable manhole guard and other components of the XTIRPA system should be inspected by a competent person in accordance with the User's Instruction and safety manual.

Do not use if inspection reveals a problem, an unsafe or defective condition. Must not be repaired by other than manufacturer or an authorized service center.

Not user repairable.

Installation and use :
Ensure that all components and parts are in perfect working condition and working properly. Make sure that your anchoring point is in perfect working condition. Remove retaining pin of the anchor adaptor, mast extension or/and approved and certified fixed or mobile adapter. Proceed to install base of mast into desired receptacle and lock system using the retaining pin at all times.

Warnings :
For all other mast applications, consult manufacturer or distributor.

Manufacturer's instructions must be followed for proper use and maintenance of this product.
Alterations or misuse of this product or failure to follow instructions may result in serious injury or death, for which manufacturer and distributor disclaim all warranties and liabilities whatsoever. User, owner and purchaser of the XTIRPA system waiving all claims, rights and recourses against manufacturer and distributor derived there from.

3 MAX

S2426-102 revD Made in Canada

		WARNING					
A		B		W			
Davit maximum Reach		Center of Mast To center of Trolley		Total Weight Required		Number of 50lb (20Kg) Weights	
A inches (mm)	B inches (mm)	W lb (Kg)					
24 (610)	64 (1626)	1500 (682)	30				
24 (610)	79 (2007)	1200 (546)	24				
24 (610)	133 (3378)	800 (364)	16				
48 (1219)	96 (2438)	2000 (909)	40				

92305-006 Rev.B

-8-
CALCULATION DIAGRAM

Ground Clearance:

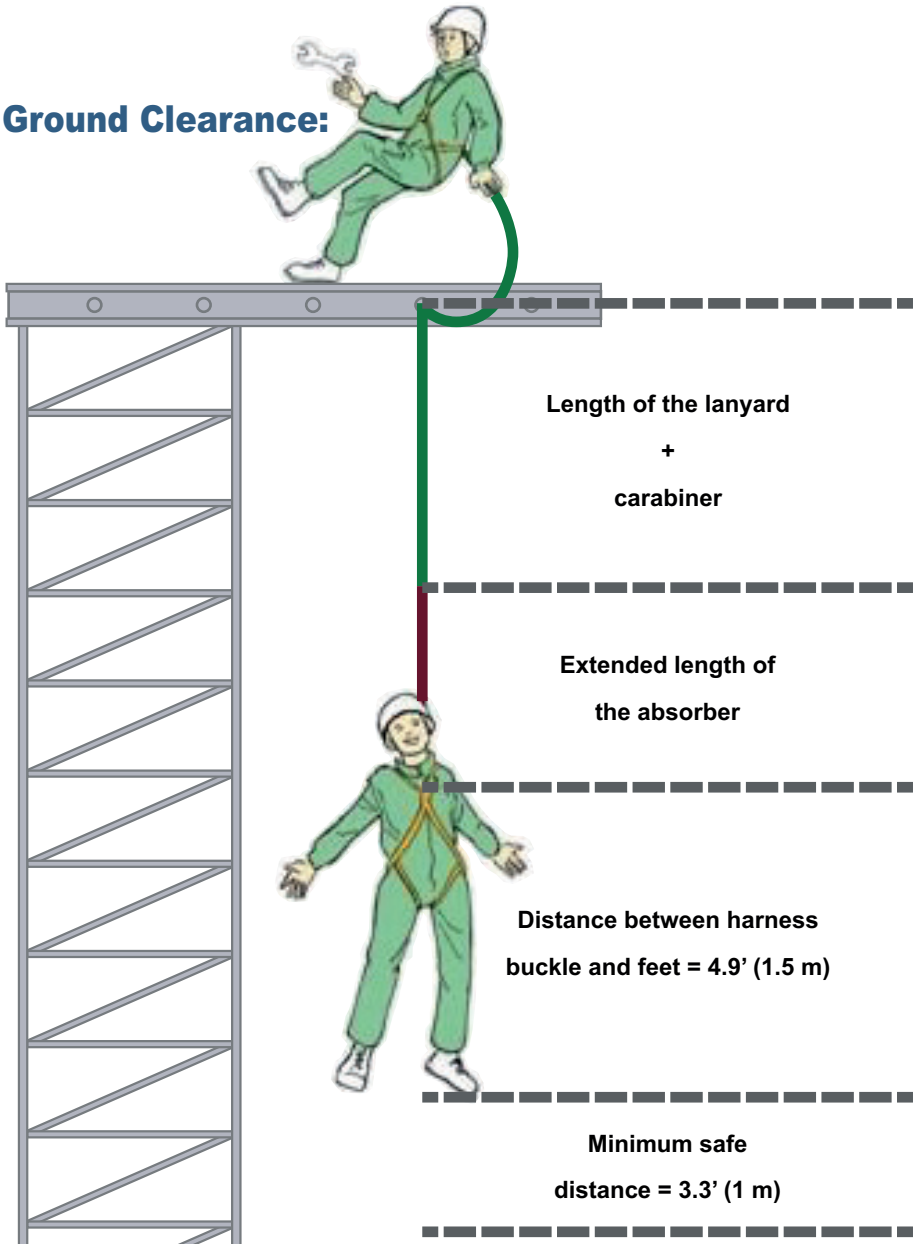

Pay attention to the distance to the ground!



REGISTRATION LIMITED WARRANTY FORM



Produits de Services Publics - Public Utility Products Inc.

This warranty applies only to the original purchaser and is the only one applicable to the Xtirpa System, and is in lieu of all other warranties, expressed or implied. The purchaser has to complete and return to INNOVA Public Utility Products Inc., all information within thirty days of purchase. Otherwise limited warranty will be void, if the product is not registered.

Register now: Mail or fax this registration form or visit our web site and register online.
Mail: INNOVA Public Utility Products Inc., 1040, boul. Industriel, Granby J2J 1A4
Fax: (450) 372-9936
Web site: www.xtirpa.com

XTIRPA PRODUCT

Model number: _____ Purchasing date: _____

Serial number: _____ Manufacturing date: _____

CUSTOMER / USER INFORMATION

Company: _____ Phone: _____

Street address: _____ Fax: _____

City: _____ State: _____ E-Mail: _____

Zip: _____

Name: _____

Position: _____

Do you wish to be on Innova's mailing list

for new product literature: YES NO

*Any failure to follow the Manufacturer's instructions contained in the instruction and safety manual, including with regard to the inspection and maintenance of the XTIRPA system and of components and parts thereof, will cause warranty to become null and void and may result in serious injury or death of the user, for which the Manufacturer disclaims all warranties and liabilities whatsoever. User, owner and purchaser of the XTIRPA system waiving all claims, rights and recourses against Manufacturer and derived there from.

Manufactured by: INNOVA Public Utility Products Inc. 1040 boul. Industriel, Granby, Quebec, Canada J2J 1A4

Tel: (450) 777-1240 Fax: (450) 372-9936

XTIRPA™

CONFINED SPACE SAFETY SOLUTIONS

Head Office and Manufacturing Plant

Innova Public Utility Productions Inc.
1040, Boulevard Industriel
Canada, Qc, Canada
J2J 1A4

Phone: 450.777.1240
Toll free: 1.800.461.1937

www.xtirpa.com



Xtirpa is a registered trademark of Innova
Public Utility Productions Inc. used under
license in Canada

MU8012-012ENG rev04