

# QUAD-13

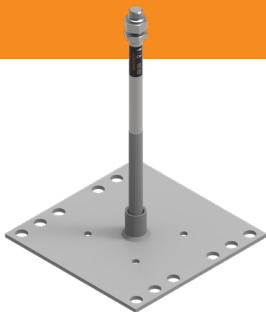

**CZ – POZOR:** Práce s výrobkem INNOTECH je povolena teprve po kompletním přečtení a porozumění bezpečnostních pokynů a návodu k montáži.

**DE – ACHTUNG:** Die Verwendung des INNOTECH-Produkts ist erst zulässig, nachdem die Sicherheitshinweise und Montageanleitung vollständig gelesen und verstanden wurden.

**DK – GIV AGT:** Det er først tilladt at anvende INNOTECH-produktet, efter du har læst og forstået sikkerhedshenvisningerne og monteringsvejledningen.

**EN – ATTENTION:** Use of the INNOTECH product is permitted only after the safety instructions and instruction manual in the respective language have been read.

**ES – ATENCIÓN:** Solo se autorizará el uso del producto INNOTECH una vez que se hayan leído y entendido completamente las indicaciones de seguridad y las instrucciones de montaje.

**FR – ATTENTION :** L'utilisation du produit INNOTECH n'est autorisée qu'après avoir intégralement lu et compris les consignes de sécurité et la notice de montage.

**HU – FIGYELEM:** Az INNOTECH termék használatát csak akkor engedhető meg, ha a biztonsági utasításokat és az összeszerelési utasításokat teljes mértékben elolvasta és megértette.

**IT – ATTENZIONE:** L'utilizzo del prodotto INNOTECH è permesso solo previa lettura completa e comprensione integrale delle avvertenze di sicurezza e le istruzioni di montaggio.

**NL – ATTENTIE:** Dit INNOTECH-product mag pas worden gebruikt nadat u de gebruikershandleiding en de montagehandleiding volledig heeft gelezen en begrepen.

**PL – UWAGA:** Używanie produktu INNOTECH jest dozwolone dopiero po zapoznaniu się z wszystkimi zasadami bezpieczeństwa i instrukcją montażu.

**PT – ATENÇÃO:** O uso do produto INNOTECH apenas é permitido depois de terem sido lidas e compreendidas na totalidade as indicações de segurança e o manual de montagem.

**SK – POZOR:** Používanie výrobku INNOTECH je povolené až vtedy, keď si úplne prečítate a pochopíte bezpečnostné pokyny a montážny návod.

**SL – POZOR:** Uporaba izdelkov INNOTECH je dovoljena šele po tem, ko preberete in so vam jasne vse varnostne opombe in navodila za montažo.

**SV – OBS :** INNOTECH-produkten får inte användas, förrän säkerhets- och monteringsinstruktionerna har lästs igenom och förstås fullständigt.

**TR – DİKKAT:** INNOTECH ürününün kullanımına ancak güvenlik uyarıları ve montaj talimatı tamamen okunup anlaşıldıktan sonra izin verilir.

**ZH – 注意:** 只有在完全阅读并理解安全提示和装配说明书之后,才允许使用INNOTECH产品。

EN 795:2012  
TYP A

EN 795:2012  
TYP C

DIN CEN/TS  
16415:2017

DIBt  
Z-14.9-732



1



2



2

3



3

4



3

5



4

6



6

7



8

2

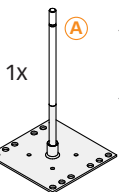
1X  **A**1X  **B**1X  **C**1X  **D**

1X

A) INNOTECH QUAD-13

B) M16 DIN985

C) M16 DIN439

D) Weicon AntiSeize ASW10000



3



[mm]

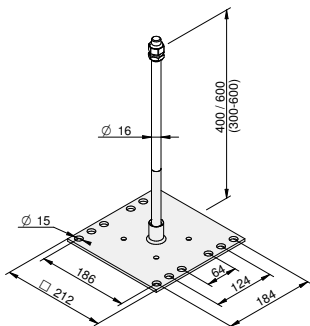

4

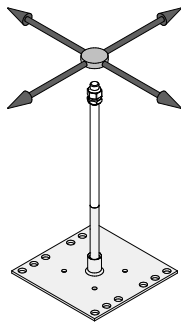

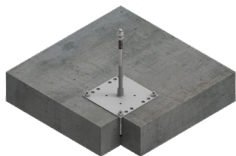
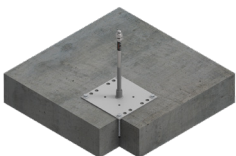

[mm]

**BEF-104-A4****BEF-111**



Ø 14



19



40

[mm]



FISCHER

**MONT-FIS-SB-390-S**  
FISCHER FIS-SB-390-S



4x M12x...	8.8 / A2-70 / A4-70
4x M12 DIN125	8.8 / A2-70 / A4-70
4x M12 DIN985	8.8 / A2-70 / A4-70

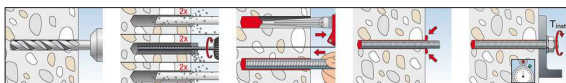
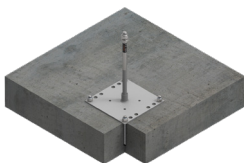

FISCHER FIS-SB-390-S

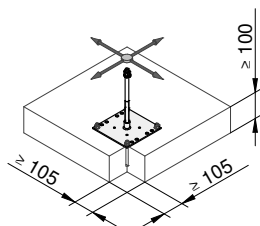
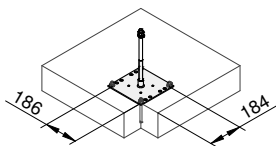
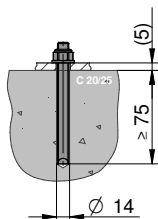

HILTI HY 200



[mm]

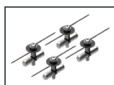

BEF-307

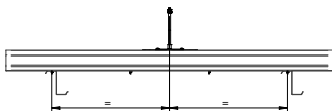
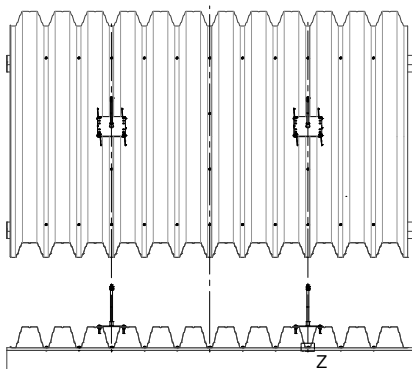
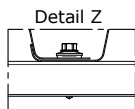
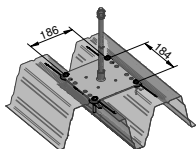
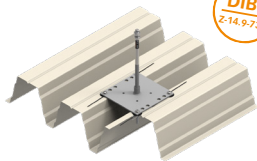

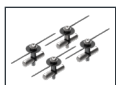
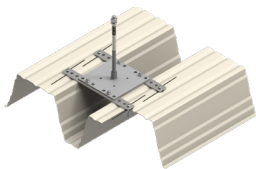

[mm]

**BEF-307****1** BEF-307-3

INNOTECH WEB-APP

# INNO|doc

Simple. Clear. Document.



[www.innotech.at/de/innodoc](http://www.innotech.at/de/innodoc)

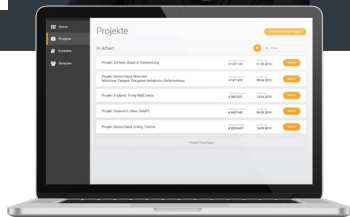

**INNOTECH Arbeitsschutz GmbH**

Laizing 10, A-4656 Kirchham

T: +43 7619 22122-0

[office@innotech.at](mailto:office@innotech.at) | [www.innotech.at](http://www.innotech.at)

