

SRT Standard Servo (DL5015)

The SRT Standard Servo provides 180° limit angle range of motion and position control for your project. Great for animatronics and ideal scale applications .

KEY FEATURES

- Ideal for 1/10 on road applications
- incredible efficiency and low power consumption
- Standard dimension make it perfect for vehicles that can benefit from a high quality servo
- Superior Holding Torque
- 1-Year Limited Warranty

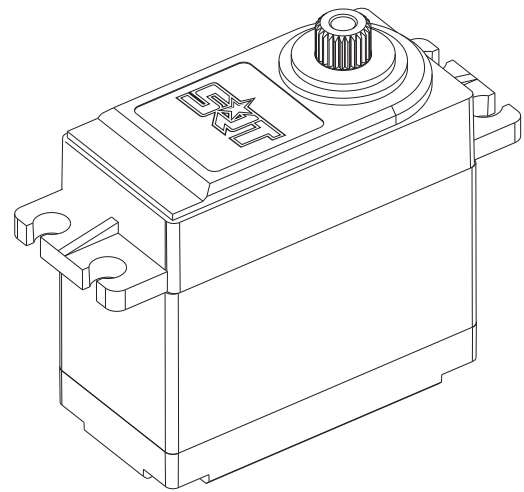

OVERVIEW

The latest generation of SRT servos provides you with the performance you need for any 1/10th to 1/8th scale vehicle application. are standard size servos for High-Voltage applications up to 6.0V, All these servos feature SRT innovations like the removable wire leads that allow for custom lead length and ease of maintenance and all metal servo mounting tabs to keep them in place through the most extreme conditions.

Power Requirement Notes

The manufacturer specifies 4.8-6.0VDC for this servo. However, we find that this servo is tolerant of a 9 V battery for very brief periods of time when there is no load, as used in some activities in the Stamps in Class series of tutorials. (Slight jittering may be observed when batteries are fresh; this does not cause damage). Do not use this servo with an unregulated wall-mount supply, or a regulated wall mount supply exceeding 6.0VDC.

Servo current draw can spike while under load. Be sure that your application's power supply and voltage regulator is prepared to supply adequate current for all servos used. Do not try to power this servo directly from a BASIC Stamp module's or any microcontroller's Vdd or Vin pins; do not connect the servo's Vss line directly to the BASIC Stamp module's or any microcontroller's Vss pin.

Apply Environmental Condition

Storage Temperature Range: -20°C~60°C

Operating Temperature Range: -10°C~50°C

Operating Voltage Range: 4.8V~6.0V

Standard Test Environment

Every characteristic of the inspect must be carried out under normal temperature and humidity, temperature 25±5°C and relative humidity 65±10%, judge the characteristics according to this standard testing conditions.

Electrical Specification (Function of the Performance)

item	4.8V	6.0V
Operating speed (at no load)	0.15 sec/60°	0.13 sec/60°
Running current at no load(Slow to Fast)	400 mA	500 mA
Stall torque (at locked)	12.0 kg-cm	15.0 kg-cm
Stall current (at locked)	2450 mA	2700 mA
Idle current (at stopped)	5mA	6mA

Note: Item definition is average value when the servo running with no load

Mechanical Specification

Item	Standard
Materials of the gear	Copper & Aluminum
Weight	63 ± 1g
Limit angle	180° ± 10°
Connector wire gauge	# 26 PVC
Connector wire length	300 ± 5 mm
Horn gear spline	ψ5.8*25T
Horn type	Single, Double
Reduction ratio	1/286
Motor Type	DC Motor

Control Specification

Item	Standard
Control system	Pulse Width Modification
Amplifier type	333Hz Digital Controller
Operating travel	90° (1500→2000 μsec)
Neutral position	1500 μsec
Dead band width	2 μsec
Rotating direction	Clockwise (when 1500→2000 μsec)
Pulse width range	800→2200 μsec
Maximum travel	Approx 125°(when 800→2200 μsec)

Appearance Inspection

Appearance: No damage which affects functions allowed

Outline Drawing: Dimension see below

*mm

