



Quick Start Guide

EN

DE

ES

FR

IT

NL

PL

GR

CZ

SK

NO

SW

DK

FI

COPYRIGHT ©2018 Hangzhou Hikvision Digital Technology Co., Ltd. or its subsidiaries. ALL RIGHTS RESERVED.

About this Manual

The Manual includes instructions for using and managing the product. Pictures, charts, images and all other information hereinafter are for description and explanation only. The information contained in the Manual is subject to change, without notice, due to firmware updates or other reasons. Please find the latest version in the **ezviz™** website (<http://www.ezvizlife.com>).

Any and all information, including, among others, wordings, pictures, graphs are the properties of Hangzhou Hikvision Digital Technology Co., Ltd. or its subsidiaries (hereinafter referred to be "Hikvision"). This user manual (hereinafter referred to be "the Manual") cannot be reproduced, changed, translated, or distributed, partially or wholly, by any means, without the prior written permission of Hikvision. Unless otherwise stipulated, Hikvision does not make any warranties, guarantees or representations, express or implied, regarding to the Manual.

Trademarks Acknowledgement

ezviz™, ™, and other Hikvision's trademarks and logos are the properties of Hikvision in various jurisdictions. Other trademarks and logos mentioned below are the properties of their respective owners.

Legal Disclaimer

TO THE MAXIMUM EXTENT PERMITTED BY APPLICABLE LAW, THE PRODUCT DESCRIBED, WITH ITS HARDWARE, SOFTWARE AND FIRMWARE, IS PROVIDED "AS IS", WITH ALL FAULTS AND ERRORS, AND HIKVISION MAKES NO WARRANTIES, EXPRESS OR IMPLIED, INCLUDING WITHOUT LIMITATION, MERCHANTABILITY, SATISFACTORY QUALITY, FITNESS FOR A PARTICULAR PURPOSE, AND NON-INFRINGEMENT OF THIRD PARTY. IN NO EVENT WILL HIKVISION, ITS DIRECTORS, OFFICERS, EMPLOYEES, OR AGENTS BE LIABLE TO YOU FOR ANY SPECIAL, CONSEQUENTIAL, INCIDENTAL, OR INDIRECT DAMAGES, INCLUDING, AMONG OTHERS, DAMAGES FOR LOSS OF BUSINESS PROFITS, BUSINESS INTERRUPTION, OR LOSS OF DATA OR DOCUMENTATION, IN CONNECTION WITH THE USE OF THIS PRODUCT, EVEN IF HIKVISION HAS BEEN ADVISED OF THE POSSIBILITY OF SUCH DAMAGES.

TO THE MAXIMUM EXTENT PERMITTED BY APPLICABLE LAW, IN NO EVENT SHALL HIKVISION'S TOTAL LIABILITY FOR ALL DAMAGES EXCEED THE PURCHASE PRICE THE PRODUCT.

HIKVISION does not undertake any liability for personal injury or property damage, as the result of product interruption or service termination cause by: a) improper installation or usage other than as requested; b) the protection of national or public interests; c) Force Majeure; d) yourself or the third party, including not limitation, using any third party's products, software, applications, and among others.

REGARDING TO THE PRODUCT WITH INTERNET ACCESS, THE USE OF PRODUCT SHALL BE WHOLLY AT YOUR OWN RISKS. HIKVISION SHALL NOT TAKE ANY RESPONSIBILITIES FOR ABNORMAL OPERATION, PRIVACY LEAKAGE OR OTHER DAMAGES RESULTING FROM CYBER ATTACK, HACKER ATTACK, VIRUS INSPECTION, OR OTHER INTERNET SECURITY RISKS; HOWEVER, HIKVISION WILL PROVIDE TIMELY TECHNICAL SUPPORT IF REQUIRED.

The purpose of the Products is to provide an adequate warning in the event of illegal encroachment in certain area; however, the proper installation of the Products will not eliminate, but only reduce, that accidents will not occur or that there will be no personal injury or property loss as a result. You are highly recommended to raise your vigilance and strengthen the safety awareness in the daily life.

SURVEILLANCE LAWS VARY BY JURISDICTION. PLEASE CHECK ALL RELEVANT LAWS IN YOUR JURISDICTION BEFORE USING THIS PRODUCT IN ORDER TO ENSURE THAT YOUR USE CONFORMS TO THE APPLICABLE LAW. YOU FURTHER AGREE THAT THIS PRODUCT IS ONLY FOR CIVIL USE, AND HIKVISION SHALL NOT BE LIABLE IN THE EVENT THAT THIS PRODUCT IS USED WITH ILLEGITIMATE PURPOSES, SUCH AS THIRD PARTY RIGHTS INFRINGEMENT, MEDICAL TREATMENT, SAFETY EQUIPMENT OR OTHER SITUATIONS WHERE THE PRODUCT FAILURE COULD LEAD TO DEATH OR PERSONAL INJURY, OR WEAPON OF MASS DESTRUCTION, CHEMICAL AND BIOLOGICAL WEAPON, NUCLEAR EXPLOSION, AND ANY UNSAFE NUCLEAR ENERGY USES OR ANTI-HUMANITY USAGES. YOU SHOULD UNDERTAKE ALL RESPONSIBILITIES FOR LOSSES OR DAMAGES RESULTING FROM THE ABOVE USAGES WHATSOEVER. IN THE EVENT OF ANY CONFLICTS BETWEEN THE ABOVE AND THE APPLICABLE LAW, THE LATER PREVAILS.

Regulatory Information

FCC Information

This device complies with Part 15 of the FCC Rules. Operation is subject to the following two conditions:

- (1) This device may not cause harmful interference, and
- (2) This device must accept any interference received, including interference that may cause undesired operation.

Note: This product has been tested and found to comply with the limits for a Class B digital device, pursuant to Part 15 of the FCC Rules. These limits are designed to provide reasonable protection against harmful interference in a residential installation. This product generates, uses, and can radiate radio frequency energy and, if not installed and used in accordance with the instructions, may cause harmful interference to radio communications. However, there is no guarantee that interference will not occur in a particular installation. If this product does cause harmful interference to radio or television reception, which can be determined by turning the equipment off and on, the user is encouraged to try to correct the interference by one or more of the following measures:

- Reorient or relocate the receiving antenna.
- Increase the separation between the equipment and receiver.
- Connect the equipment into an outlet on a circuit different from that to which the receiver is connected.
- Consult the dealer or an experienced radio/TV technician for help.

Please take attention that changes or modification not expressly approved by the party responsible for compliance could void the user's authority to operate the equipment.

This equipment should be installed and operated with a minimum distance 20cm between the radiator and your body.

This device complies with Industry Canada licence-exempt RSS standard(s). Operation is subject to the following two conditions:

- (1) this device may not cause interference, and
- (2) this device must accept any interference, including interference that may cause undesired operation of the device.

Under Industry Canada regulations, this radio transmitter may only operate using an antenna of a type and maximum (or

lesser) gain approved for the transmitter by Industry Canada. To reduce potential radio interference to other users, the antenna type and its gain should be so chosen that the equivalent isotropically radiated power (e.i.r.p.) is not more than that necessary for successful communication.



EU Conformity Statement

This product and - if applicable - the supplied accessories too are marked with "CE" and comply therefore with the applicable harmonized European standards listed under the Radio Equipment Directive 2014/53/EU, the EMC Directive 2014/30/EU, the RoHS Directive 2011/65/EU.



2012/19/EU (WEEE directive): Products marked with this symbol cannot be disposed of as unsorted municipal waste in the European Union. For proper recycling, return this product to your local supplier upon the purchase of equivalent new equipment, or dispose of it at designated collection points. For more information see: www.recyclethis.info.



2006/66/EC (battery directive): This product contains a battery that cannot be disposed of as unsorted municipal waste in the European Union. See the product documentation for specific battery information. The battery is marked with this symbol, which may include lettering to indicate cadmium (Cd), lead (Pb), or mercury (Hg). For proper recycling, return the battery to your supplier or



to a designated collection point. For more information see: www.recyclethis.info.

EC DECLARATION OF CONFORMITY

Hereby, Hangzhou Hikvision Digital Technology Co., Ltd. declares that the radio equipment type [CS-DP1, CS-DP1i, CS-DP1C, CS-DP1S, CS-DP2, CS-DP2i, CS-DP2C, CS-DP2S, CS-DP3, CS-DP3i, CS-DP3C, CS-DP3S] is in compliance with Directive 2014/53/EU.

The full text of the EC DECLARATION OF CONFORMITY is available at the following web link:

<http://www.evizlife.com/declaration-of-conformity>.

Safety Instruction

Due to the product shape and dimension, the name and address of the importer/manufacture are printed on the package.

SAVE THIS MANUAL FOR FUTURE REFERENCE

Attention

- Do not expose the camera to the harsh environment like high temperature, humid, salt mist, or rain, otherwise, the device may be damaged.
- Do not press the sensor or lens of the camera, otherwise, the device may be damaged.
- Do not pull the wire of the camera hardly, and protect yourself from being cut by the wire. Damage to the wire due to inappropriate operation is not included in the warranty.
- Use the exclusively power adapter to charge the panel, otherwise, the system may be damaged.

Box Content



Camera (x1)



Panel (x1)



Mounting Base (x1)



Screws (x3)



Base Buckle (x1)



Wire Buckle (x1)



Cable (x1)



Power Adapter (x1)



Quick Start Guide (x1)

Overview Panel

EN

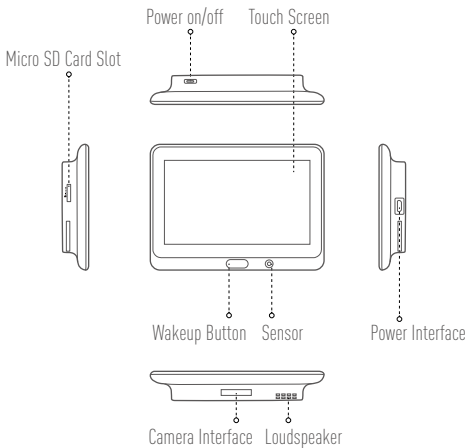

Camera

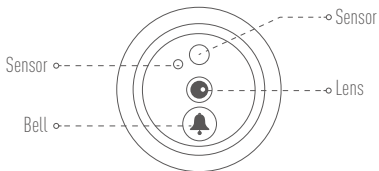

i Do not block the sensors.

Mounting Base

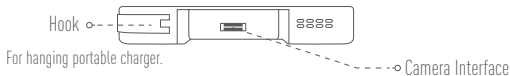
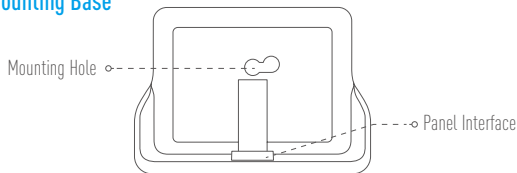

Installation

- If you used to install the peephole, remove it and install the device in the same place. If not, please drill a hole of diameter about 16.5 to 30mm and about 145cm distance from the ground to have a good viewing effect.

1



Measure the door's thickness and select the appropriate screw.

Thickness

35 to 60mm

60 to 85mm

85 to 100mm

Screw



2



Turn the screw into the back of camera.

3



Tear off the release paper.

4



Pass screw and wire through the door.
You can roll up the paper to help.

5



Adjust camera's position and
push it close to the door gently.

6



Connect the mounting base
with the camera's wire.

7



Insert the buckle and
press it tightly to fix it.

8



Adjust the mounting base's position and tighten the screw.

9



Put the wires in the groove and insert the buckle.

10



Slide the panel into the mounting base.

11



Hold the power button to power on the panel.

Power on

Hold the power button for 3 to 5 seconds to power up the panel.

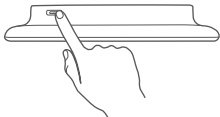



 Album

 Record

 Set

Tap  to set detailed parameters as you desired such as Display, Monitoring, Date, and etc.

Connect to Wi-Fi

1



2

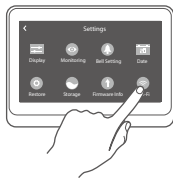

3



4



Select your Wi-Fi and enter password.

Add to EZVIZ App

- 1 Create an user account.
 - Connect your mobile phone to Wi-Fi.
 - Download and install the EZVIZ app by searching "EZVIZ" in App Store and Google Play™.
 - Launch the app and register an EZVIZ user account following the start-up wizard.
- 2 Add a camera to EZVIZ.
 - Log in the EZVIZ app.
 - On the Home screen, tap "+" on the upper-right corner to go to the scan QR code page.

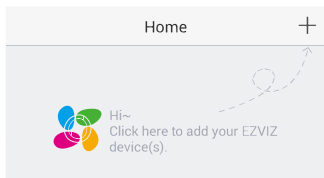

- Scan the QR code.

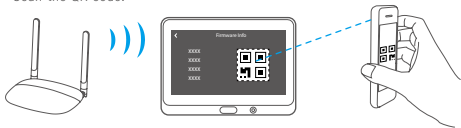

-  Tap **Firmware Info** to view the QR code.

Charge the Panel

Connect the panel with the power outlet via power adapter.

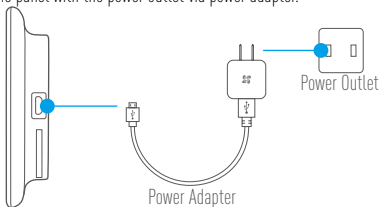

- Recommended Charging Time: 5 to 6 hours.
- You can also charge the panel via portable charger and hang it on the hook.

Achtung

- Setzen Sie die Kamera keinen widrigen Umgebungsbedingungen wie hohen Temperaturen, Feuchtigkeit, Salznebel oder Regen aus, da das Gerät dadurch beschädigt werden kann.
- Quetschen Sie nicht den Sensor oder das Kameraobjektiv, da das Gerät dadurch beschädigt werden kann.
- Ziehen Sie nicht am Kamerakabel und vermeiden Sie Abrisse. Schäden am Kabel aufgrund unsachgemäßen Gebrauchs sind von der Garantie nicht abgedeckt.
- Verwenden Sie zum Laden des Bildschirms nur das mitgelieferte Netzteil, da sonst das System beschädigt werden kann.

Inhalt



1x Kamera



Bildschirm (x1)



Montagefuß (x1)



Schrauben (x3)



Fußschnalle (x1)



Kabelschließe (x1)



Kabel (x1)



Netzteil (x 1)



Kurzanleitung (x1)

Überblick Bildschirm

DE

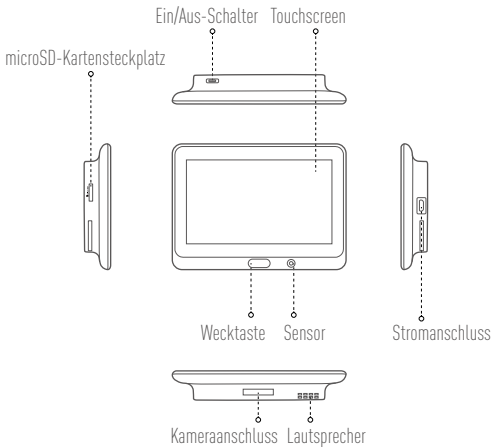

Kamera

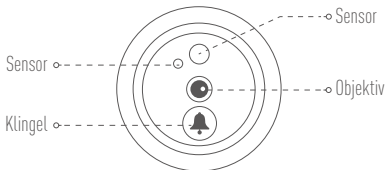

i Verdecken Sie nicht die Sensoren.

Montagefuß

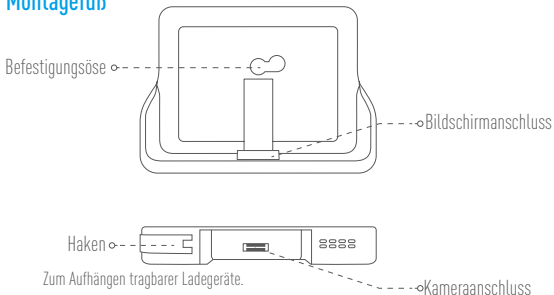

Installation

- Wenn Sie schon einen Türspion angebracht haben, entfernen Sie diesen und befestigen Sie die Kamera an der gleichen Stelle. Andernfalls bohren Sie bitte ein Loch von ca. 16,5 bis 30 mm Durchmesser und einer Höhe über dem Boden von ca. 145 cm. So erhalten Sie die beste Sicht.

1



Messen Sie die Dicke der Tür ab und wählen Sie eine passende Schraube.

Dicke

35 bis 60 mm

60 bis 85 mm

85 bis 100 mm

Schraube



2



Drehen Sie die Schraube in die Rückseite der Kamera ein.

3



Reißen Sie das Trennpapier ab.

4



Führen Sie Schraube und Kabel durch die Tür.
Als Führungshilfe können Sie das
Trennpapier aufrollen.

5



Arretieren Sie die Kamera und
schieben Sie sie vorsichtig
bis an die Tür heran.

6



Bringen Sie den Montagefuß
am Kamerakabel an.

7



Setzen Sie die Schnalle ein und
drücken Sie sie zum Fixieren fest an.

8



Arretieren Sie den Montagefuß und ziehen Sie die Schraube fest.

9



Legen Sie das Kabel in die Nut und stecken Sie die Schließe fest.

10



Schieben Sie den Bildschirm über den Montagefuß.

11



Zum Einschalten des Geräts halten Sie den Ein/Aus-Schalter gedrückt.

Einschalten

Zum Einschalten des Geräts halten Sie den Ein/Aus-Schalter 3 bis 5 Sekunden lang gedrückt.

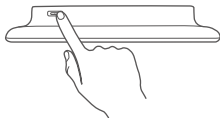



 Album

 Aufnehmen

 Einstellungen

DE

Mit einem Fingertipp auf  können Sie detaillierte Werte wie Anzeige, Überwachung, Datum usw. einstellen.

Mit WLAN verbinden

1



2



3



4



Wählen Sie Ihr WLAN und geben Sie Ihr Passwort ein.

Zu EZVIZ-App hinzufügen

- 1 Ein Benutzerkonto erstellen.
 - Verbinden Sie Ihr Mobiltelefon mit einem WLAN.
 - Laden Sie die EZVIZ-App durch eine Suche nach „EZVIZ“ im App Store oder in Google Play™ herunter und installieren Sie sie.
 - Starten Sie die App und registrieren Sie sich für ein EZVIZ-Benutzerkonto gemäß den Anweisungen im Startassistenten.
- 2 Eine Kamera zu EZVIZ hinzufügen.
 - Melden Sie sich an der EZVIZ App an.
 - Tippen Sie im Startbildschirm in der oberen rechten Ecke auf „+“, um auf die Seite zum Scannen des QR-Codes zu gelangen.

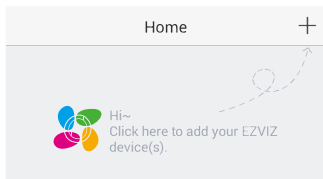

-Scannen Sie den QR-Code.

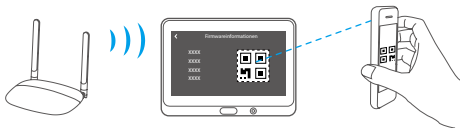

Tippen Sie **Firmware Info (Firmwaredaten)** zum Anzeigen des QR-Codes an.

Bildschirm laden

Schließen Sie den Bildschirm über das Netzteil an eine Steckdose an.

DE

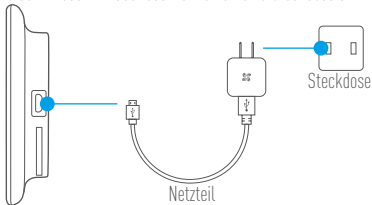

- i** • Empfohlene Ladezeit: 5 bis 6 Stunden.
- Sie können den Bildschirm auch über ein tragbares Ladegerät aufladen, das Sie an den Haken hängen.

Advertencia

- No exponga la cámara a condiciones extremas, como altas temperaturas, humedad, niebla salina o lluvia. De lo contrario, el dispositivo podría resultar dañado.
- No presione el sensor o la lente de la cámara, de lo contrario, el dispositivo podría resultar dañado.
- No tire con fuerza del cable de la cámara, y procure que el cable no le corte. Los daños al cable producidos por un trato inapropiado no quedarán cubiertos por la garantía.
- Utilice el adaptador de corriente exclusivamente para cargar el panel; de lo contrario, el sistema podría dañarse.

Contenido de la caja



Cámara (x1)



Panel (x1)



Base de montaje (x1)



Tornillos (x3)



Hebilla de base (x1)



Alambre de base (x1)



Cable (x1)



Adaptador de corriente (x1)



Guía de inicio rápido (x1)

Descripción general

Panel

ES

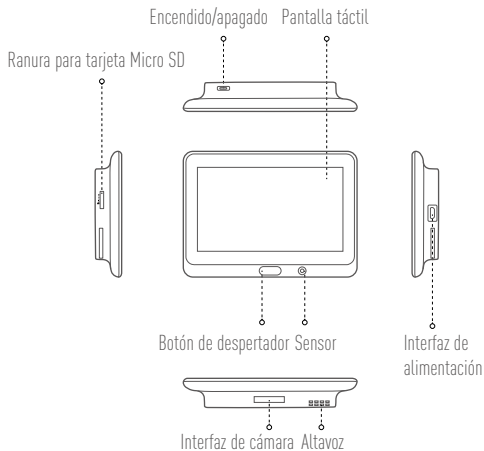

Cámara

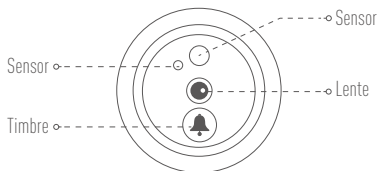

i No bloquee los sensores.

Base de montaje

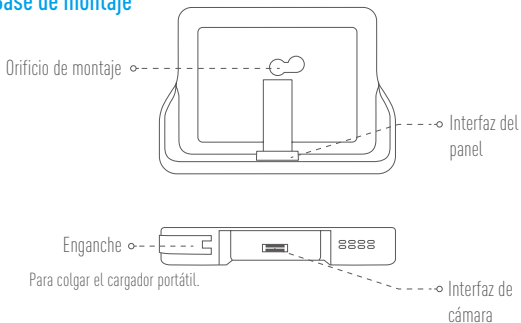

Instalación

- Si tenía la instalación de la mirilla hecha, retírela e instale dispositivo en el mismo lugar. De lo contrario, perforo un orificio de un diámetro de aproximadamente 16,5 a 30 mm y a una distancia de aproximadamente 145 cm del suelo a fin de conseguir un buen efecto visual.

1



Mida el grosor de la puerta y seleccione el tornillo apropiado.

Grosor

35 a 60 mm

60 a 85 mm

85 a 100 mm

Tornillo



2



Gire el tornillo en la parte posterior de la cámara.

3



Tire del papel antiadhesivo.

4



Pase el tornillo y el cable a través de la puerta.
Puede enrollar el papel para ayudarse.

5



Ajuste la posición de la cámara y empujela hacia la puerta suavemente.

6



Conecte la base de montaje con el cable de la cámara.

7

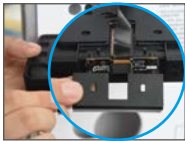

Inserte la hebilla y presiónela para fijarla.

8



Ajuste la posición de la base de montaje y apriete el tornillo.

9



Coloque los cables en la ranura e inserte la hebilla.

10



Deslice el panel en la base de montaje.

11



Mantenga presionado el botón de encendido para encender el panel.

Encendido

Mantenga presionado el botón de encendido durante 3 a 5 segundos para encender el panel.

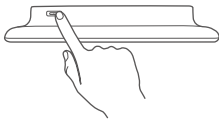



- Álbum
- Grabar
- Configurar

ES

Toque para configurar los parámetros detallados, como Mostrar, Monitorización, Fecha, etc.

Conexión a Wi-Fi

1



2

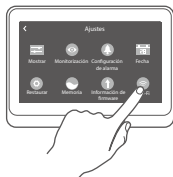

3



4

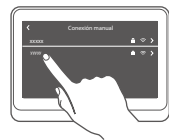

Seleccione su Wi-Fi e introduzca la contraseña.

Añadir a la aplicación EZVIZ

- 1 Cree una cuenta de usuario.
 - Conecte su teléfono móvil a la red Wi-Fi.
 - Descargue e instale la app EZVIZ buscando "EZVIZ" en el App Store y Google Play™.
 - Abra la app y registre una cuenta de usuario de EZVIZ siguiendo las instrucciones del asistente de instalación.
- 2 Agregue una cámara a EZVIZ.
 - Inicie sesión en la aplicación EZVIZ.
 - En la pantalla de inicio, toque "+" en la esquina superior derecha para ir a la página de escaneo de códigos QR.

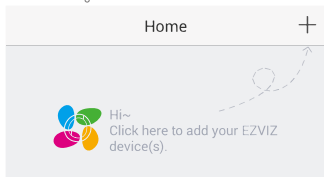

-Escanear el código QR.

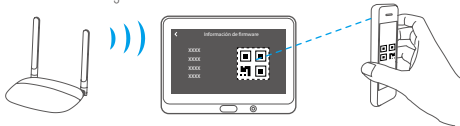

i Toque sobre **Información de Firmware** para ver el código QR.

Cargue el panel

Conecte el panel con la toma de corriente mediante el adaptador de corriente.



ES

- i** • Tiempo de carga recomendado: 5 a 6 horas.
- También puede cargar el panel mediante un cargador portátil y colgarlo del enganche.

Attention

- N'exposez pas la caméra à un environnement rude tel que de fortes températures, l'humidité, le brouillard salin et la pluie, sinon cela peut l'endommager.
- N'appuyez pas sur les capteurs ou l'objectif de la caméra, sinon cela peut endommager l'appareil.
- Ne tirez pas fortement sur le câble de la caméra et évitez de vous couper avec. L'endommagement du câble en raison d'une mauvaise utilisation est exclu de la garantie.
- Utilisez uniquement l'adaptateur d'alimentation fourni pour charger l'écran, sinon cela peut causer un dysfonctionnement du système.

Contenu de la boîte



Caméra (x1)



Écran (x1)



Base de montage (x1)



Vis (x3)



Fixation de la base (x1)



Fixation du câble (x1)



Câble (x1)



Adaptateur d'alimentation (x1)



Guide de démarrage rapide (x1)

Présentation

Écran

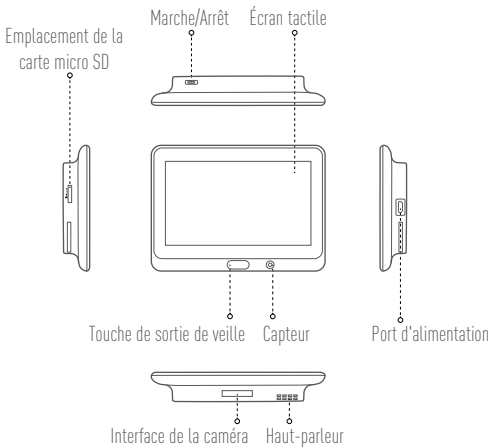

Caméra

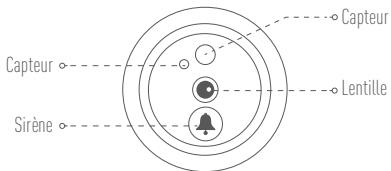

i N'obstruez pas les capteurs.

Base de montage

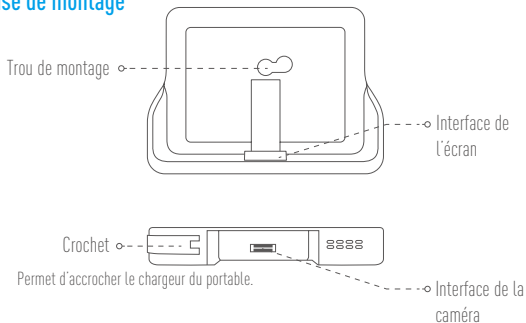

Installation

- Si la porte comporte un judas, retirez-le et installez l'appareil dans cet endroit même. Dans le cas contraire, percez un trou de 16,5 à 30 mm de diamètre situé à environ 145 cm du sol pour avoir une bonne vue.

1



Mesurez l'épaisseur de la porte et sélectionnez la vis la mieux indiquée.

Épaisseur

35 à 60 mm

60 à 85 mm

85 à 100 mm

Vis



2



Vissez la vis au dos de la caméra.

3



Retirez le papier de protection.

4



Passez la vis et le câble à travers la porte.
Roulez le papier pour faciliter l'opération.

5



Ajustez la position de la caméra et
poussez-la délicatement pour
la rapprocher de la porte.

6



Branchez le câble de la caméra sur
la base de montage.

7



Insérez la fixation et appuyez
fermement pour la fixer.

8



Réglez la position de la base de montage et vissez la vis.

9



Faites passer les câbles dans le trou et installez la fixation.

10



Faites coulisser l'écran dans la base de montage.

11



Appuyez longuement sur le bouton d'alimentation pour mettre l'écran sous tension.

Mise sous tension

Appuyez pendant 3 à 5 secondes sur le bouton d'alimentation pour allumer l'écran.

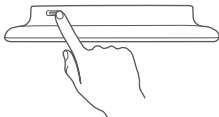



Album



Enregistrer



Configurer

Touchez l'icône  pour configurer à votre guise les paramètres détaillés : Afficher, Surveillance, Date, etc.

FR

Connexion Wi-Fi

1



2

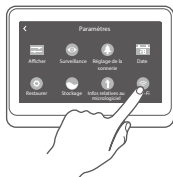

3



4

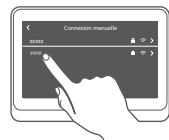

Sélectionnez votre réseau Wi-Fi et saisissez votre mot de passe.

Ajouter à l'application EZVIZ

1 Créer un compte utilisateur.

- Connectez votre téléphone mobile au réseau Wi-Fi.
- Téléchargez et installez l'application EZVIZ en recherchant « EZVIZ » dans l'App Store ou Google Play™.
- Lancez l'application et créez un compte utilisateur EZVIZ en suivant l'assistant de démarrage.

2 Ajouter une caméra à EZVIZ.

- Connectez-vous dans l'application EZVIZ.
- Sur l'écran d'accueil, touchez le bouton « + » situé dans le coin supérieur droit pour accéder à la page de numérisation du code QR.

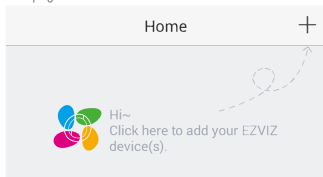

- Scannez le code QR.

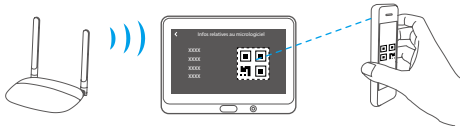

-  Touchez l'icône **Infos relatives au micrologiciel** pour afficher le code QR.

Charge de l'écran

À l'aide de l'adaptateur d'alimentation, branchez l'écran sur la prise d'alimentation.

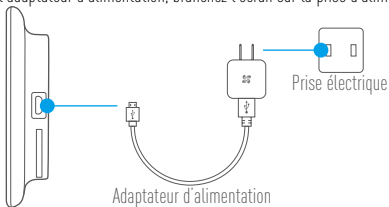

FR

- i** • Durée de charge recommandée : 5 à 6 heures.
- Vous pouvez également charger l'écran via un chargeur de portable et le fixer sur le crochet.

Attenzione

- Non esporre la telecamera a condizioni ambientali difficili, quali temperature estreme, umidità, salinità, o pioggia, che potrebbero danneggiare il dispositivo.
- Non sottoporre a pressioni l'obiettivo e il sensore della telecamera, altrimenti il dispositivo potrebbe danneggiarsi.
- Non tirare il filo della telecamera e proteggersi da eventuali tagli causati dal filo. Danni al filo dovuti a un utilizzo scorretto non sono coperti dalla garanzia.
- Per la ricarica, utilizzare esclusivamente l'adattatore di alimentazione in dotazione per evitare danni al sistema.

Contenuto della confezione



1 Telecamera



Pannello (x1)



Base di montaggio (x1)



Viti (x3)



Chiusura della base (x1)



Chiusura del filo (x1)



Cavo (x1)



Alimentatore (x1)



Guida rapida (x1)

Panoramica Pannello

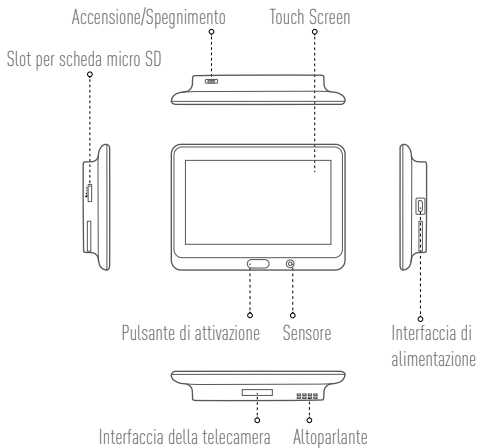

IT

Telecamera

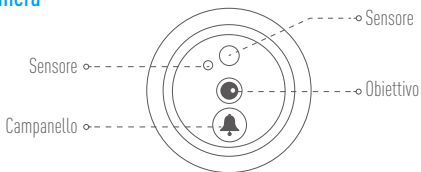

i Non bloccare i sensori.

Base di montaggio

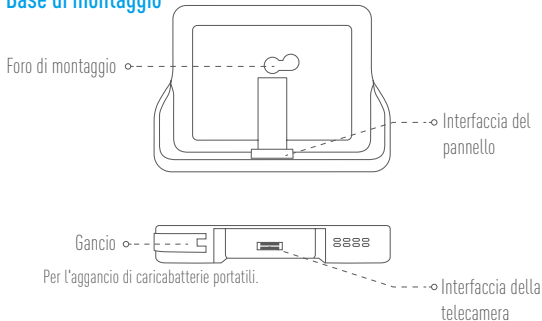

Installazione

- Se in precedenza avete già installato uno spioncino, rimuovetelo e installate questo nuovo, nello stesso punto. In caso contrario, praticare un foro dal diametro compreso tra 16,5 e 30 mm a una distanza di circa 145 cm dal suolo, per garantire una buona visuale.

1



Misurare lo spessore della porta e usare la vite appropriata.

Spessore

da 35 a 60 mm

da 60 a 85 mm

da 85 a 100 mm

Vite



2



Applicare la vite nel retro della telecamera.

3



Rimuovere la carta protettiva.

IT

4



Far passare la vite e il cavo attraverso la porta.
Se necessario, è possibile aiutarsi avvolgendo la carta.

5



Regolare la posizione della telecamera e appoggiarla delicatamente alla porta.

6



Collegare la base di montaggio al cavo della telecamera.

7



Inserire e premere la chiusura strettamente per fissarla.

8



Regolare la posizione della base di montaggio e stringere la vite.

9



Inserire il cavo nella scanalatura e applicare la chiusura.

10



Far scorrere il pannello nella base di montaggio.

11



Tenere premuto l'interruttore per accendere il pannello.

Accensione

Tenere premuto l'interruttore dai 3 ai 5 secondi per attivare il pannello.

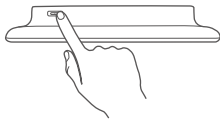



 Album

 Registra

 Imposta

Toccare  per impostare come richiesto i parametri di dettaglio, quali Visualizzazione, Monitoraggio, Data, Wi-Fi, etc.

IT

Connessione al Wi-Fi

1



2

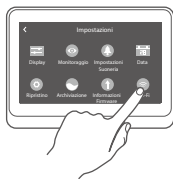

3



4



Da Impostazioni -> Wi-Fi per selezionare la propria rete Wi-Fi ed inserire la password.

Aggiunta all'app EZVIZ

- 1 Creare un account utente.
 - Connettere il cellulare alla rete Wi-Fi.
 - Scaricare e installare l'app EZVIZ cercando "EZVIZ" in App Store o Google Play™.
 - Avviare l'app e registrare un account utente di EZVIZ seguendo le istruzioni della procedura guidata all'avvio.
- 2 Aggiungere una telecamera a EZVIZ.
 - Accedere all'app EZVIZ.
 - Nella schermata iniziale, toccare "+" nell'angolo superiore destro per passare alla pagina di scansione del QR code.

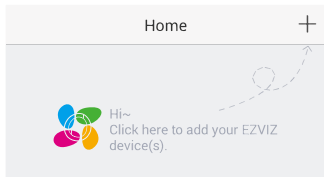

-Scansione del codice QR.



-  Toccare **Firmware Info (Informazioni firmware)** per visualizzare il codice QR.

Ricarica del pannello

Collegare il pannello alla presa di corrente tramite l'adattatore di alimentazione.



IT

- i** • Tempo di ricarica suggerito: 5-6 ore.
- Il pannello può anche essere ricaricato tramite caricatori portatili, applicandolo al gancio.

Pas op

- Stel de camera niet bloot aan barre omstandigheden zoals hoge temperaturen, vocht, zoute nevel of regen, omdat het apparaat anders beschadigd kan raken.
- Druk niet op de sensor of lens van de camera, omdat het apparaat anders beschadigd kan raken.
- Trek niet te hard aan het snoer van de camera en let erop dat u uzelf niet snijdt aan het snoer. Schade aan de kabel als gevolg van onjuist gebruik is niet inbegrepen in de garantie.
- Gebruik de originele voedingsadapter om het paneel op te laden, omdat het apparaat anders beschadigd kan raken.

Inhoud van de doos



Camera (x1)



Paneel (x1)



Houder (x1)



Schroef (x3)



Basisgesp (x1)



Snoergesp (x1)



Kabel (x1)



Voedingsadapter (x1)



Snelstartgids (x1)

Overzicht Paneel

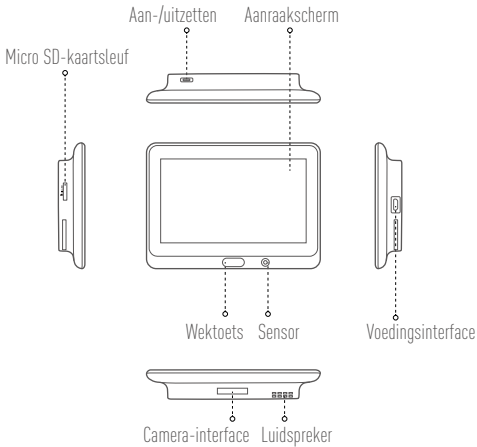

NL

Camera

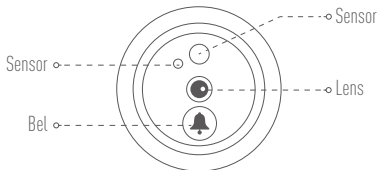

i Blokkeer de sensoren niet.

Montagevoet

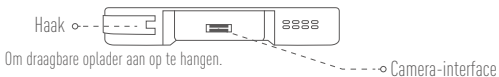
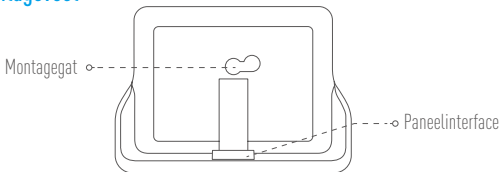

Installatie

- Als u het kijkgaatje hebt geïnstalleerd, verwijdert u deze en installeert u het apparaat op dezelfde plaats. Zo niet, boor dan voor een goed zicht een gat met een diameter van ongeveer 16,5 tot 30 mm en op ongeveer 145 cm afstand van de grond.

1



Meet de dikte van de deur en gebruik de juiste schroef.

Dikte

35 tot 60 mm

60 tot 85 mm

85 tot 100 mm

Schroef



2



Draai de schroef in de achterzijde van de camera.

3



Verwijder het bescherm papier.

4



Leid de schroef en de draad door de deur. U kunt er een stuk papier omheen rollen om bij het doorvoeren te helpen.

5



Pas de positie van de camera aan en duw deze voorzichtig dicht tegen de deur aan.

NL

6



Verbind de houder met het snoer van de camera.

7



Plaats de basisgesp en druk stevig vast om deze vast te zetten.

8



Verstel de positie van de houder en draai de schroef vast.

9



Steek de snoeren in de groef en steek de snoergesp erin.

10



Schuif het paneel in de houder.

11



Houd de aan/uit-knop ingedrukt om het paneel aan te zetten.

Inschakelen

Houd de aan/uit-knop 3 tot 5 seconden ingedrukt om het paneel aan te zetten.

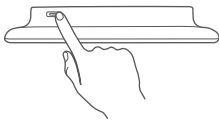



 Album

 Opnemen

 Instellen

Tik op  om de gewenste gedetailleerde parameters in te stellen, zoals Display (Weergave), Monitoring (Toezicht houden), Date (Datum), enz.

NL

Met wifi verbinden

1



2

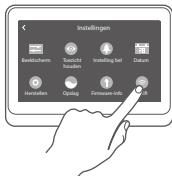

3



4



Selecteer uw wifi en voer het wachtwoord in.

Aan EZVIZ-app toevoegen

- 1 Een gebruikersaccount aanmaken.
 - Verbind uw mobiele telefoon met de wifi.
 - Download en installeer de EZVIZ-app door "EZVIZ" te zoeken in App Store en Google Play™.
 - Start de app en registreer een EZVIZ-gebruikersaccount via de opstartwizard.
- 2 Een camera toevoegen aan EZVIZ.
 - Log in op de EZVIZ-app.
 - Tik in het startscherf op "+" in de rechter bovenhoek om de pagina voor het scannen van de QR-code te openen.

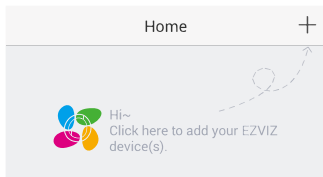

-Scan de QR-code.

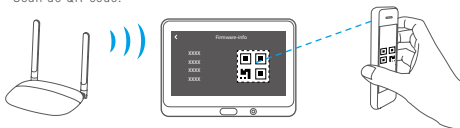

 Tik op **Firmware Info (Firmware-info)** om de QR-code te bekijken.

Het paneel opladen

Sluit het paneel aan op een stopcontact met behulp van de voedingsadapter.

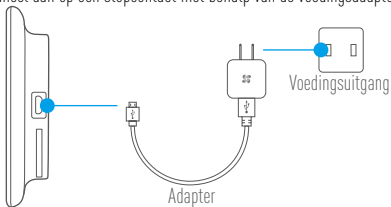

NL

- i** • Aanbevolen oplaadtijd: 5 tot 6 uur.
- U kunt het paneel ook opladen met behulp van een draagbare oplader en aan de haak hangen.

Uwaga

- Nie narażaj kamery na działanie ekstremalnych warunków, takich jak wysoka temperatura, wilgotność, słone opary lub deszcz, gdyż może to spowodować uszkodzenie urządzenia.
- Nie naciskaj czujnika ani kamery, gdyż może to spowodować uszkodzenie urządzenia.
- Nie ciągnij za przewód kamery i zachowaj ostrożność, aby nie skaleczyć się przewodem. Uszkodzenie przewodu wynikające z niepoprawnej obsługi nie jest objęte gwarancją.
- Do ładowania panelu używaj wyłącznie dostarczonego zasilacza, w przeciwnym razie może dojść do uszkodzenia urządzenia.

Zawartość opakowania



Kamera (x1)



Panel (x1)



Podstawa montażowa
(x1)



Śruby (x3)



Zatrzask podstawy (x1)



Zatrzask przewodu (x1)



Przewód (x1)



Zasilacz (x1)



Skrócona instrukcja
obsługi (x1)

Przeгляд

Panel

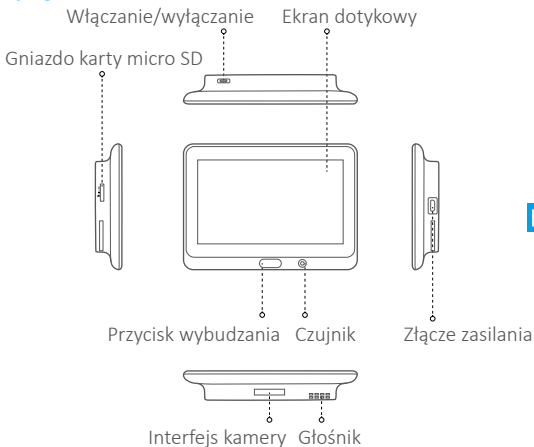

PL

Kamera

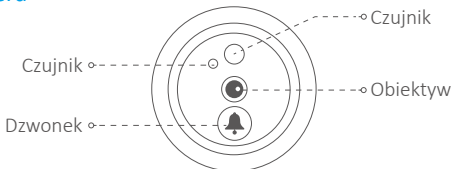

i Nie zastanawiaj czujników.

Podstawa montażowa

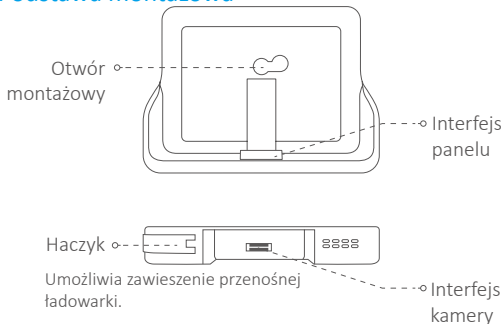



Instalacja

- Jeżeli wcześniej zainstalowano wizjer, należy go zdemontować, a w jego miejsce zainstalować urządzenie. Jeżeli wizjer nie był zainstalowany, należy wywiercić otwór o średnicy od ok. 16,5 mm do 30 mm, na wysokości około 145 cm od podłogi, co zapewni dobre pole widzenia.

1



Zmierz grubość drzwi i wybierz śrubę odpowiedniej długości.

Grubość	Śruba
35–60 mm	
60–85 mm	
85–100 mm	

2



Wkręć śrubę od tyłu kamery.

3



Oderwij papier ochronny.

4



Przełóż śrubę i przewód przez drzwi. Aby ułatwić sobie zadanie, możesz owinąć ją papierem.

5

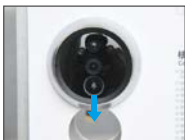

Wyreguluj położenie kamery i ostrożnie dociśnij ją do drzwi.

PL

6



Połącz podstawę montażową z przewodem kamery.

7



Założ zatrzask i naciśnij go, aby zabezpieczyć połączenie.

8



Wyreguluj położenie podstawy montażowej i dokręć śrubę.

9



Umieść przewody w rowku i załóż zatrzask.

10



Nasuń panel na podstawę montażową.

11



Aby włączyć panel, przytrzymaj przycisk zasilania.

Włączanie zasilania

Przytrzymaj przycisk zasilania przez 3–5 sekund, aby włączyć zasilanie panelu.

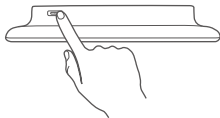



 Album

 Nagrywanie

 Konfiguracja

Dotknij , aby wybrać takie ustawienia, jak Display (Wyświetlacz), Monitoring, Date (Data) itp.

Łączenie z siecią Wi-Fi

PL

1



2



3



4



Wybierz sieć Wi-Fi i wprowadź hasło.

Dodawanie do aplikacji EZVIZ

- 1** Utwórz konto użytkownika.
 - Połącz telefon komórkowy z siecią Wi-Fi.
 - W App Store lub Google Play™ wyszukaj „EZVIZ”, a następnie pobierz i zainstaluj aplikację EZVIZ.
 - Uruchom aplikację i zarejestruj swoje konto użytkownika EZVIZ przy użyciu kreatora startowego.
- 2** Dodaj kamerę do aplikacji EZVIZ.
 - Zaloguj się w aplikacji EZVIZ.
 - Na ekranie głównym wybierz przycisk „+” znajdujący się w prawym górnym rogu, aby przejść do strony skanowania kodów QR.

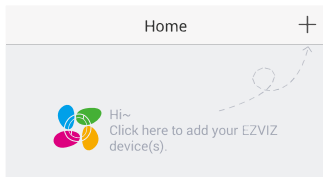

-Zeskanuj kod QR.

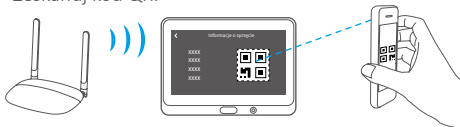

- i** Dotknij Firmware Info (Informacje o sprzęcie) , aby wyświetlić kod QR.

Ładowanie panelu

Podłącz panel do gniazda zasilającego za pomocą zasilacza.

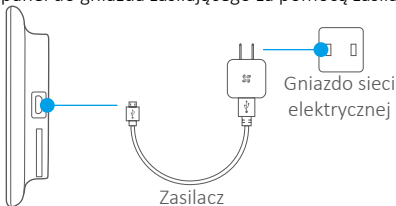

PL

- i** • Zalecany czas ładowania: 5 –6 godzin.
- Panel można również ładować za pomocą przenośnej ładowarki, którą można zawiesić na haczyku.

Προσοχή

- Μην εκθέτετε την κάμερα σε αντίξοες περιβαλλοντικές συνθήκες, όπως υψηλή θερμοκρασία, υγρασία, αλατούχο νέφος ή βροχή, διαφορετικά υπάρχει κίνδυνος πρόκλησης βλάβης στη συσκευή.
- Μην πιέζετε τον αισθητήρα ή τον φακό της κάμερας, διαφορετικά υπάρχει κίνδυνος πρόκλησης βλάβης στη συσκευή.
- Μην τραβάτε απότομα το σύρμα της κάμερας και προσέχετε να μην κοπείτε από αυτό. Η πρόκληση βλάβης στο σύρμα λόγω ανάρμοστου χειρισμού δεν καλύπτεται από την εγγύηση.
- Χρησιμοποιείτε το αποκλειστικό τροφοδοτικό για τη φόρτιση της οθόνης, διαφορετικά υπάρχει κίνδυνος πρόκλησης βλάβης στο σύστημα.

Περιεχόμενα συσκευασίας



Κάμερα (x1)



Οθόνη (x1)



Βάση τοποθέτησης
(x1)



Βίδες (x3)



Πόρπη βάσης (x1)



Πόρπη σύρματος (x1)



Καλώδιο (x1)



Τροφοδοτικό (x1)



Οδηγός γρήγορης
έναρξης (x1)

Επισκόπηση Οθόνη

Ενεργοποίηση/Απενεργοποίηση Οθόνη αφής

Θύρα κάρτας Micro SD

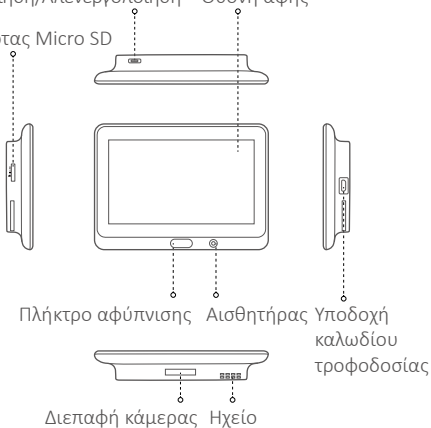

Κάμερα

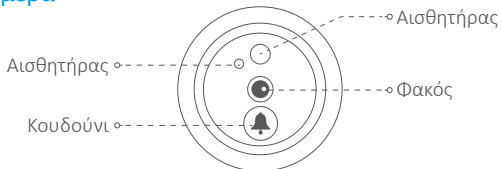

i Μη φράσσετε τους αισθητήρες.

Βάση τοποθέτησης

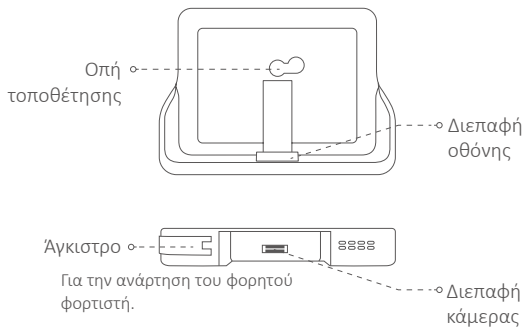

Εγκατάσταση

- Εάν έχετε εγκαταστήσει ματάκι, αφαιρέστε το και τοποθετήστε τη συσκευή στο ίδιο σημείο. Διαφορετικά, ανοίξτε μια οπή διαμέτρου περίπου από 16,5 έως 30 mm και απόστασης από το έδαφος περίπου 145 cm για να έχετε καλή γωνία θέασης.

1



Μετρήστε το πάχος της πόρτας και επιλέξτε την κατάλληλη βίδα.

Πάχος

35 έως 60 mm

60 έως 85 mm

85 έως 100 mm

mm

Βίδα



2



Βιδώστε τη βίδα στο πίσω μέρος της κάμερας.

3



Αφαιρέστε το προστατευτικό χαρτί.

4



Περάστε τη βίδα και το σύρμα μέσα από την πόρτα. Μπορείτε να τυλίξετε το χαρτί για να βοηθηθείτε.

5



GR

Προσαρμόστε τη θέση της κάμερας και σπρώξτε την κοντά στην πόρτα απαλά.

6



Συνδέστε τη βάση τοποθέτησης με το σύρμα της κάμερας.

7



Τοποθετήστε την πόρπη και πιέστε την απαλά για να σταθεροποιηθεί.

8



Προσαρμόστε τη θέση της βάσης τοποθέτησης και σφίξτε τη βίδα.

9



Περάστε τα σύρματα από την εγκοπή και εισάγετε την πόρπη.

10



Τοποθετήστε συρταρωτά την οθόνη στη βάση τοποθέτησης.

11



Κρατήστε πατημένο το κουμπί ενεργοποίησης της οθόνης.

Ενεργοποίηση

Κρατήστε πατημένο το κουμπί για 3 έως 5 δευτερόλεπτα, για να ενεργοποιήσετε την οθόνη.

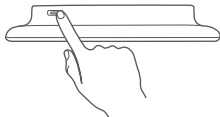



 Φωτογραφίες

 Εγγραφή

 Ρύθμιση

Αγγίξτε  για να ορίσετε λεπτομερείς παραμέτρους σύμφωνα με τις προτιμήσεις σας, όπως Display (Οθόνη), Monitoring (Παρακολούθηση), Date (Ημερομηνία) κ.λπ.

Σύνδεση με Wi-Fi

GR

1



2

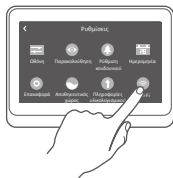

3



4



Επιλέξτε το Wi-Fi σας και πληκτρολογήστε τον κωδικό πρόσβασης.

Προσθήκη στην εφαρμογή EZVIZ

- 1** Δημιουργήστε έναν λογαριασμό χρήστη.
 - Συνδέστε το κινητό σας τηλέφωνο στο Wi-Fi.
 - Κατεβάστε και εγκαταστήστε την εφαρμογή EZVIZ αναζητώντας τον όρο "EZVIZ" στο App Store και το Google Play™.
 - Εκκινήστε την εφαρμογή και δημιουργήστε έναν λογαριασμό χρήστη EZVIZ ακολουθώντας τον οδηγό εκκίνησης.
- 2** Προσθέστε μια κάμερα στο EZVIZ.
 - Συνδεθείτε στην εφαρμογή EZVIZ.
 - Στην αρχική οθόνη, πατήστε «+» στην πάνω δεξιά γωνία για να μεταβείτε στη σελίδα σάρωσης κωδικού QR.

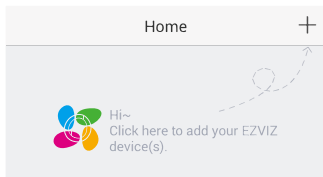

-Σαρώστε τον κωδικό QR.

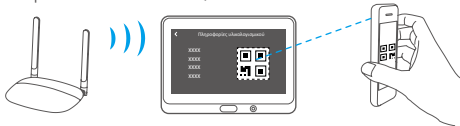

- i** Αγγίξτε **Firmware Info** (Πληροφορίες υλικολογισμικού) για να προβάλτε τον κωδικό QR.

Φόρτιση οθόνης

Συνδέστε την οθόνη με την έξοδο ισχύος μέσω τροφοδοτικού.

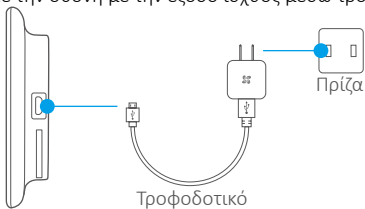

- Προτεινόμενος χρόνος φόρτισης: 5 έως 6 ώρες.
- Μπορείτε επίσης να φορτίσετε την οθόνη με τον φορητό φορτιστή, αναρτώντας στον στο άγκιστρο.

GR

Pozor

- Nevystavujte kameru náročným prostředím, například vysokým teplotám, vlhkosti, slané tříšti nebo dešti, protože by mohlo dojít k jejímu poškození.
- Netlačte na snímač nebo čočku kamery, mohlo by dojít k poškození zařízení.
- Nevtahujte kabel z kamery silou a chraňte se před možným pořezáním kabelem. Poškození kabelu v důsledku nesprávné manipulace není kryto zárukou.
- K napájení panelu používejte výhradně napájecí adaptér. V opačném případě může dojít k poškození systému.

Obsah balení



Kamera (1x)

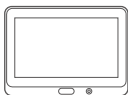

Panel (1x)



Montážní základna (1x)



Šrouby (3x)



Úchytka základny (1x)



Úchytka kabelu (1x)



Kabel (1x)



Napájecí adaptér (1x)



Stručná příručka (1x)

Přehled Panel

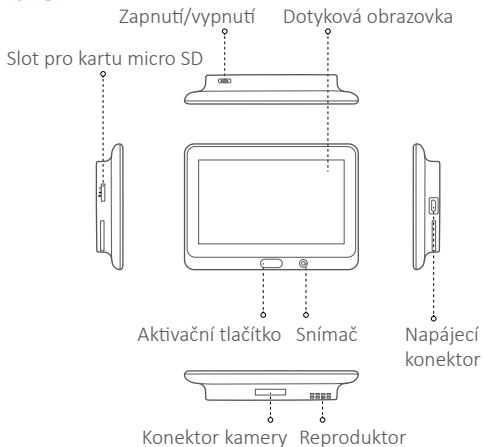

CZ

Kamera

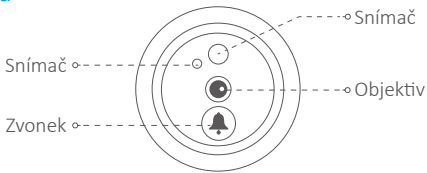

i Nezakrývejte snímače.

Montážní základna

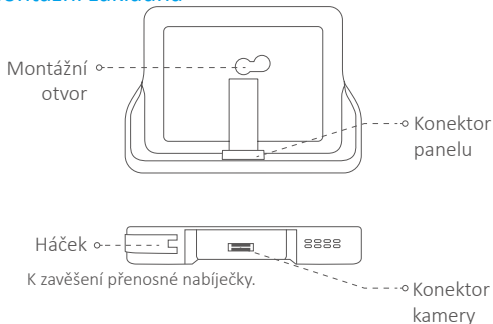

Montáž

- Pokud máte nainstalované kukátko, odstraňte jej a na stejné místo instalujte toto zařízení. V opačném případě vyvrtejte otvor o průměru 16,5 až 30 mm ve vzdálenosti přibližně 145 cm od země, aby měla kamera dobrý záběr.

1



Změřte tloušťku dveří a vyberte vhodný šroub.

Tloušťka

35 až 60 mm

60 až 85 mm

85 až 100 mm

Šroub



2



Zašroubujte jej do zadní části kamery.

3



Odrhňte krycí papír.

4



Protáhněte šroub a kabel dveřmi. Pro snadnější manipulaci můžete papír stočit.

5



Upravte polohu kamery a jemně ji zatlačte do dveří.

CZ

6



Připojte montážní základnu s kabelem kamery.

7

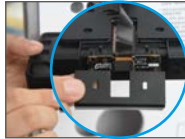

Vložte úchytku a pevně ji zatlačte, abyste ji zafixovali na místě.

8



Upravte polohu montážní základny a šroub utáhněte.

9



Vložte kabely do drážky a vložte úchytku.

10



Zasuňte panel do montážní základny.

11



Zapněte panel podržením vypínače.

Zapnutí

Zapněte panel stisknutím a podržením tlačítka vypínače po dobu 3 až 5 sekund.

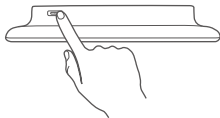



 Album

 Záznam

 Nastavení

Klepněte na ikonu  a podle potřeby nastavte podrobné parametry, například Display (Displej), Monitoring (Sledování), Date (Datum) atd.

Připojení k síti Wi-Fi

1



2

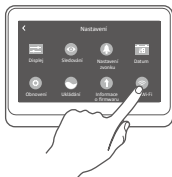

3



4

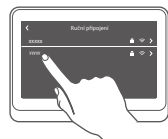

Zvolte síť Wi-Fi a zadejte heslo.

CZ

Přidání do aplikace EZVIZ

- 1** Vytvořte si uživatelský účet.
 - Připojte mobilní telefon k síti Wi-Fi.
 - Stáhněte si a nainstalujte aplikaci EZVIZ tak, že vyhledáte „EZVIZ“ v obchodech App Store a Google Play™.
 - Spusťte aplikaci. Postupujte podle pokynů průvodce prvním spuštěním a zaregistrujte svůj uživatelský účet EZVIZ.
- 2** Přidejte kameru do aplikace EZVIZ.
 - Přihlaste se do aplikace EZVIZ.
 - Na domovské obrazovce přejděte klepnutím v pravém horním rohu na tlačítko „+“ na stránku skenování kódu QR.

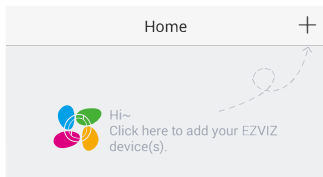

- Naskenujte kód QR.

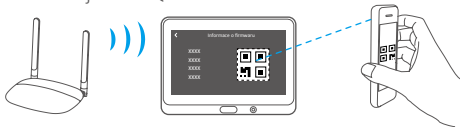

- i** Klepnutím na možnost Firmware Info (Informace o firmwaru) zobrazíte kód QR.

Nabíjení panelu

Panel připojte do zásuvky přes napájecí adaptér.

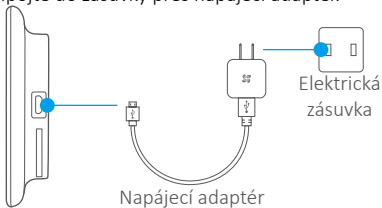

- i** • Doporučená doba nabíjení: 5 až 6 hodin.
- Panel můžete nabít také pomocí přenosné nabíječky, kterou lze zavěsit na háček.

CZ

Pozor

- Nevystavujte kameru náročným podmienkam, ako je vysoká teplota, vlhkosť, slaná hmla alebo dážď, inak môže dôjsť k poškodeniu zariadenia.
- Netlačte snímač ani objektív kamery, inak môže dôjsť k poškodeniu zariadenia.
- Neťahajte nasilu kábel kamery a chráňte sa pred porezaním káblom. Na poškodenie kábla v dôsledku nevhodnej prevádzky sa nevzťahuje záruka.
- Na nabíjanie panela používajte výhradne napájací adaptér, inak môže dôjsť k poškodeniu systému.

Obsah balenia



Kamera (1 x)



Panel (1 x)



Montážna základňa
(1 x)



Skrutky (3 x)



Spona základne (1 x)



Spona kábla (1 x)



Kábel (1 x)



Sieťový adaptér (1 x)



Príručka so stručným
návodom (1 x)

Prehľad

Panel

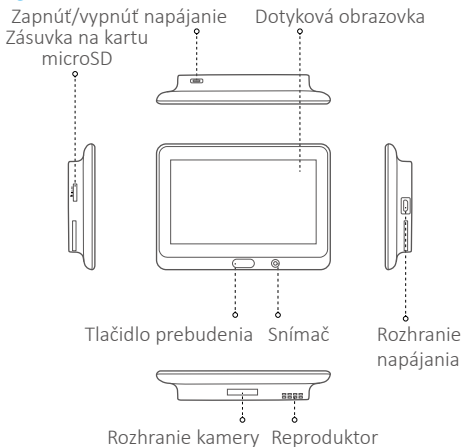

SK

Kamera

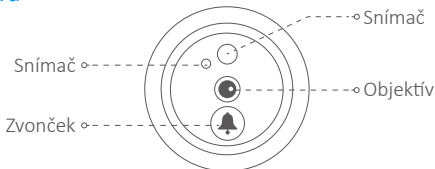

i Snímače neblokujte.

Montážna základňa

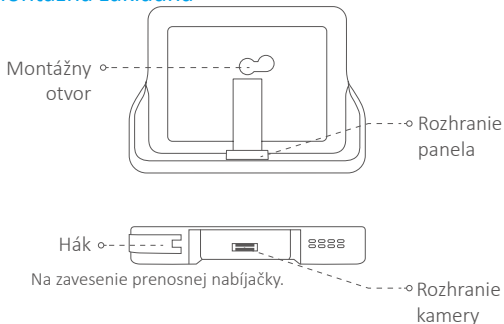

Inštalácia

- Ak ste nainštalovali priezor, odstráňte ho a na jeho miesto nainštalujte zariadenie. V opačnom prípade vyvrtajte otvor s priemerom približne 16,5 až 30 mm vo vzdialenosť približne 145 cm od zeme, aby ste mali dobrý pozorovací uhol.

1



Zmerajte hrúbku dverí a vyberte príslušnú skrutku.

Hrúbka	Skrutka
35 až 60 mm	
60 až 85mm	
85 až 100mm	

2



Skrutku naskrutkujte do zadnej časti kamery.

3



Odrhnite ochranný papier.

4



Skrutku a kábel prevlečte cez dvere. Ako pomôcku môžete použiť zrolovaný papier.

5



Upravte polohu kamery a jemne ju potlačte blízko ku dverám.

SK

6



Pripojte kábel kamery k montážnej základni.

7



Vložte sponu a upevnite ju zatlačením tak, aby teste doliehala.

8



Nastavte polohu montážnej základne a utiahnite skrutku.

9



Dajte káble do drážky a vložte sponu.

10



Zasuňte panel do montážnej základne.

11



Podržaním vypínača zapnete panel.

Zapnutie

Podržaním vypínača na 3 až 5 sekúnd zapnete panel.

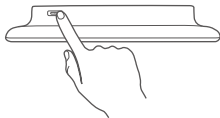



 Album

 Zaznamenať

 Nastaviť

Ak chcete nastaviť požadované parametre, ako napríklad Display (Displej), Monitoring (Monitorovanie), Date (Dátum) atď., ťuknite na ikonu .

Pripojenie k sieti Wi-Fi

1



2



3



4



Vyberte svoju sieť Wi-Fi a zadajte heslo.

SK

Pridanie do aplikácie EZVIZ

- 1** Vytvorenie používateľského účtu.
 - Pripojte mobilný telefón k sieti Wi-Fi.
 - Stiahnite a nainštalujte aplikáciu EZVIZ vyhľadáním názvu „EZVIZ“ v obchode App Store a Google Play™.
 - Spustíte aplikáciu a zaregistrujte používateľský účet EZVIZ podľa sprievodcu pri spustení.
- 2** Pridanie kamery do účtu EZVIZ.
 - Prihláste sa do aplikácie EZVIZ.
 - Na obrazovke Home (Domov) klepnite na znamienko „+“ v pravom hornom rohu, aby ste prešli na stránku skenovania QR kódu.

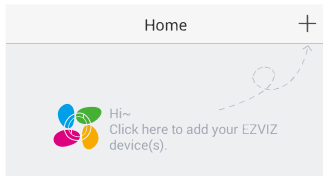

-Naskenujte kód QR.

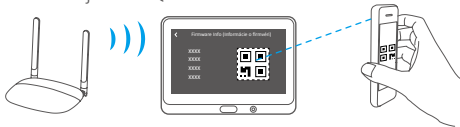

- i** Ťuknutím na položku Firmware Info (Informácie o firmvéri) zobrazíte kód QR.

Nabíjanie panela

Zapojte panel do zásuvky pomocou napájacieho adaptéra.

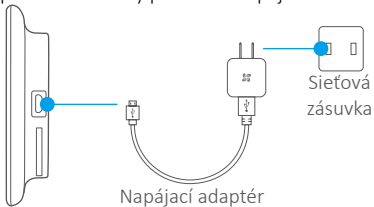

- i** • Odporúčaná doba nabíjania: 5 až 6 hodín.
- Panel môžete tiež nabíjať pomocou prenosnej nabíjačky a zavesiť ju na hák.

SK

Viktig

- Ikke utsett kameraet for skadelige omgivelser som f.eks. høy temperatur, fuktighet, salt tåke eller regn. Dette kan skade enheten.
- Ikke trykk på kameraets sensor eller linse. Dette kan skade enheten.
- Ikke trekk hardt i ledningen til kameraet, og vær forsiktig så du unngår å kutte deg på ledningen. Skader som påføres ledningen på grunn av feil bruk, dekkes ikke av garantien.
- Bruk kun den medfølgende strømadapteren for å lade panelet. Hvis ikke, kan systemet skades.

Innhold i pakken



Kamera (x 1)



Panel (x1)



Monterings sokkel (x1)



Skruer (x3)



Beskyttelsesplate for sokkel (x1)



Beskyttelsesplate for ledning (x1)



Kabel (x1)



Strømadapter (x1)



Hurtigstartveiledning (x1)

Oversikt Panel

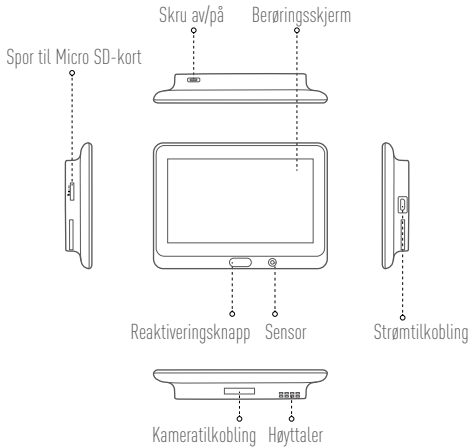

NO

Kamera

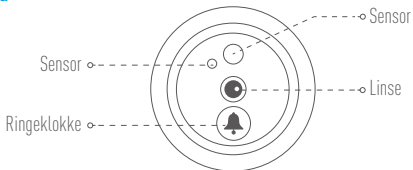

i Ikke blokker sensorene.

Monterings sokkel

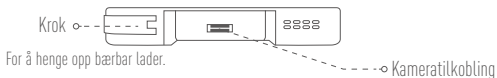
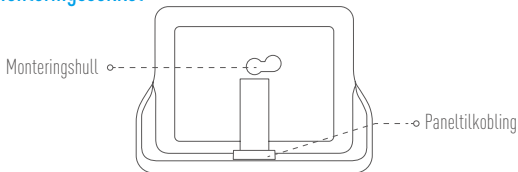

Installasjon

- Hvis du allerede har et kikkhull, fjern dette og installer enheten på samme plass. Hvis ikke, bore et hull med 16,5 til 30 mm i diameter og med en avstand på omtrent 145 cm fra bakken for å oppnå en god visning.

1



Mål dørens tykkelse, og velg passende skruer.

Tykkelse

35 til 60 mm

60 til 85 mm

85 til 100 mm

Skruer



2



Sett skruen inn på baksiden av kameraet.

3



Fjern papiret fra tapen.

4



Før skruen og ledningen gjennom døren.
Du kan rulle et ark rundt for å gjøre det lettere.

5



Juster kameraets posisjon,
og press det forsiktig mot døren.

NO

6



Koble ledningen fra kameraet
til monteringssockelen.

7



Sett på beskyttelsesplaten,
og trykk den godt på plass.

8



Juster monteringssokkelens posisjon, og stram til skruen.

9



Legg ledningene i sporet, og sett på beskyttelsesplaten.

10



Skvyp panelet ned i monteringssokkelen.

11



Hold inne strømknappen for å slå på panelet.

Slå på

Hold inne strømknappen i 3 til 5 sekunder for å slå på panelet.

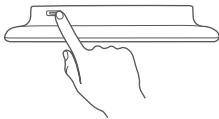



 Album

 Ta opp

 Innstillinger

Trykk på  for å stille inn detaljerte parametere etter ønske, slik som f.eks. skjerm, overvåking, dato osv.

Koble til Wi-Fi

1



2

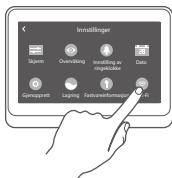

3



4



Velg ditt Wi-Fi-nettverk og tast inn passord.

NO

Legge til EZVIZ-appen

- 1 Opprett en brukerkonto.
 - Koble mobiltelefonen til et Wi-Fi-nettverk.
 - Last ned og installer EZVIZ-appen ved å søke etter "EZVIZ" i App Store eller Google Play™.
 - Start appen, og opprett en EZVIZ-brukerkonto ved å følge oppstartsveiviseren.
- 2 Legg til et kamera til EZVIZ.
 - Logg inn på EZVIZ-appen.
 - Trykk på "+" øverst til høyre på startsidene for å gå til siden hvor du kan skanne QR-koden.

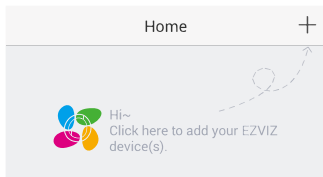

-Skanne QR-koden.

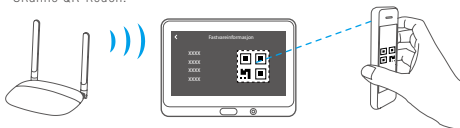

i Trykk på **Firmware Info (Fastvareinformasjon)** for å se QR-koden.

Lade panelet

Koble panelet til en stikkontakt via strømadapteren.

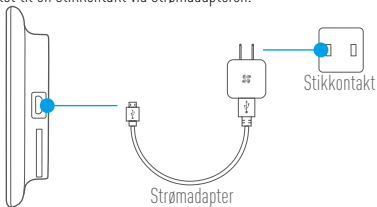

- Anbefalt ladetid: 5 til 6 timer.
- Du kan også lade panelet via den bærbare laderen som kan henges på kroken.

Obs

- Utsätt inte kameran för tuffa miljöer som hög temperatur, luftfuktighet, saltdimma eller regn, då detta kan skada enheten.
- Tryck inte på kamerans sensor eller lins, då detta kan skada enheten.
- Dra inte hårt i kamerakabeln, och akta dig för att skära dig på kabeln. Garantin täcker inte skador på kabeln som uppstår till följd av olämplig användning.
- Använd rätt strömadapter för att ladda panelen, så att systemet inte skadas.

Förpackningens innehåll



Kamera (x 1)



Panel (x1)



Monteringssockel (x1)



Skrudar (x3)



Socketspänne (x1)



Kabelspänne (x1)



Kabel (x1)



Strömadapter (x 1)



Snabbstartsguide (x 1)

Översikt

Panel

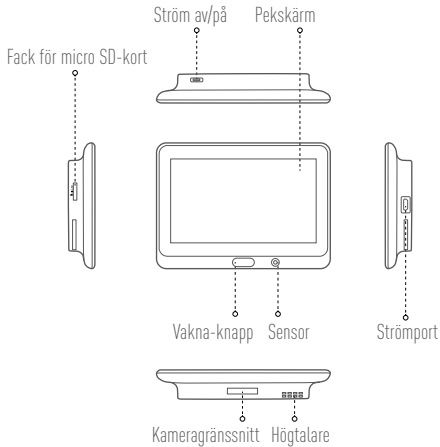

SW

Kamera

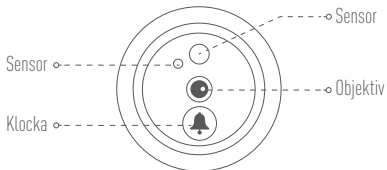

i Blockera inte sensorerna.

Monteringsplatta

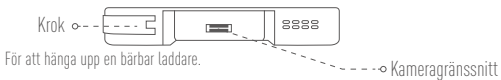
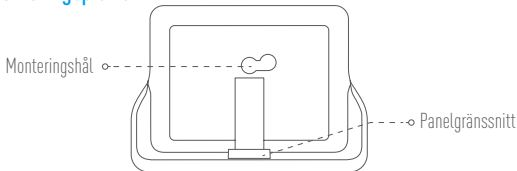

Installation

- Om du tidigare har installerat titthålet, ta bort det och installera enheten på samma plats. Om inte borrar du ett hål med en diameter på ungefär 16,5 till 30 mm ungefär 145 cm från marken för att få en god översikt.

1



Mät dörrens tjocklek och välj en lämplig skruv.

Tjocklek

35 till 60 mm

60 till 85 mm

85 till 100 mm

Skruv



2



Skruva i skruven i kamerans baksida.

3



Dra loss skyddspapperet.

4



För skruven och kabeln genom hålet.
Du kan underlätta genom
att rulla papperet runt.

5



Justera kamerans position och
tryck den försiktigt mot dörren.

6



Anslut monteringssockeln
till kamerakabeln.

7



Sätt i spännet och tryck fast det ordentligt.

SW

8



Justera monteringssockelns position och dra åt skruven.

9



Placera kablarna i skåran och sätt i spännet.

10



Skjut ned panelen i monteringssockeln.

11



Håll inne strömknappen för att sätta igång panelen.

Slå på strömmen

Håll inne strömknappen i 3 till 5 sekunder för att sätta igång panelen.

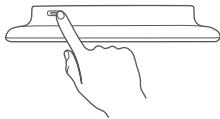



 Album

 Spela in

 Ställ in

Tryck på  för att ställa in särskilda parametrar efter önskemål, som Display (Visning), Monitoring (Övervakning), Date (Datum) osv.

Anslut till Wi-Fi

1



2



3



4



Välj ditt Wi-Fi och ange lösenordet.

SW

Lägg till i EZVIZ-appen

- 1 Skapa ett användarkonto.
 - Anslut din mobiltelefon till Wi-Fi.
 - Ladda ned och installera EZVIZ-appen genom att söka efter "EZVIZ" på App Store eller Google Play™.
 - Starta appen och registrera ett användarkonto för EZVIZ med hjälp av följande startguide.
- 2 Lägg till en kamera i EZVIZ.
 - Logga in i appen EZVIZ.
 - Tryck på "+" i det övre, högra hörnet av startskärmen för att gå till sidan för att skanna QR-kod.

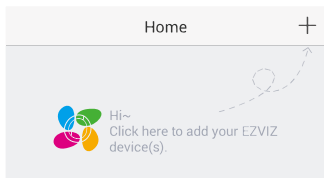

-Skanna QR-koden.

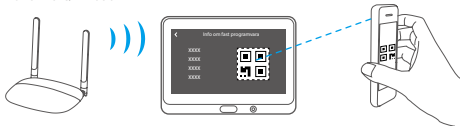

-  Tryck på **Firmware Info** (Info om fast programvara) för att visa QR-koden.

Ladda panelen

Anslut panelen till eluttaget med strömadaptern.

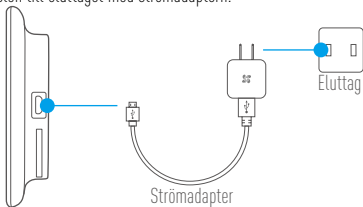

- Rekommenderad laddningstid: 5 till 6 timmar.
- Du kan också ladda panelen med en bärbar laddare och hänga den på kroken.

Bemærk

- Udsæt ikke kameraet for voldsomme driftsbetingelser som f.eks. høje temperaturer, fugt, saltvandssprøjt eller regn, som kan beskadige enheden.
- Tryk ikke på kameraets sensor eller objektiv, idet det kan beskadige enheden.
- Træk ikke hårdt i kameraets ledning, og pas på ikke at blive skåret af ledningen. Beskadigelse af ledningen på grund af forkert anvendelse dækkes ikke af garantien.
- Brug kun den medfølgende strømadapter til at oplade panelet, ellers kan systemet blive beskadiget.

Kassens indhold



Kamera (x 1)



Panel (x 1)



Monteringsfod (x 1)



Skruer (x 3)



Beslag til fod (x 1)



Lukkeenhed til ledning (x 1)



Kabel (x 1)



Strømadapter (x1)



Startvejledning (x1)

Overblik Panel

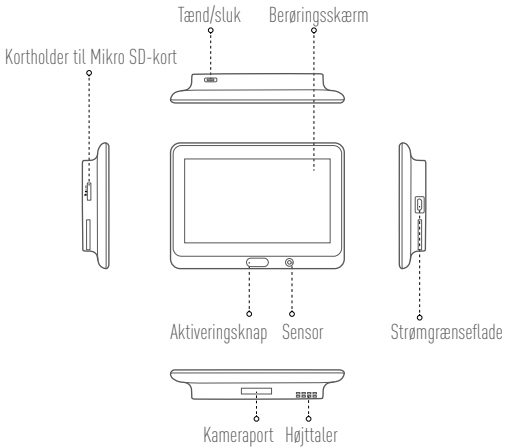

Kamera

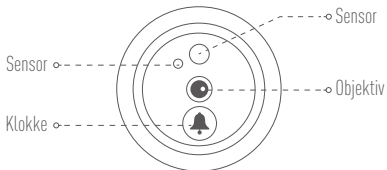

DK

i Undgå at tildække sensorerne.

Monteringsplade

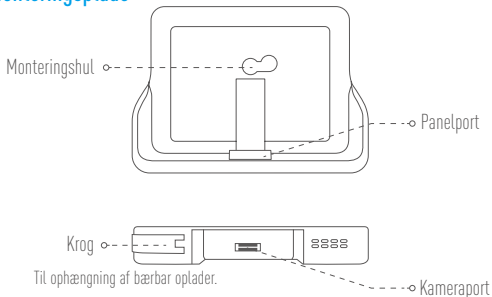

Installation

- Hvis der allerede er installeret en dørspion, skal du fjerne den og installere enheden det samme sted. Ellers skal du bore et hul med en diameter på 16,5-30 mm i en højde over jorden på 145 cm. Derved opnås det bedste synsfelt.

1



Mål dørens tykkelse, og vælg en passende skrue.

Tykkelse

35-60 mm

60-85 mm

85-100 mm

Skruer



2



Skrue skruen ind i kameraets bagside.

3



Riv slipfolien af.

4



Før skruen og ledning gennem døren.
Det er lettere, hvis du ruller papiret omkring.

5



Reguler kameraets position,
og skub det forsigtigt tættere på døren.

6



Tilslut monteringsfoden
og kameraets kabel.

7



Indsæt beslaget, og tryk det fast.

DK

8



Sæt monteringsfoden på plads, og stram skruen.

9



Læg ledningerne i rillen, og fastgør lukkeenheden.

10



Skyd panelet ned i monteringsfoden.

11



Hold tænd/sluk-knappen nede for at tænde panelet.

Tænd for strømmen

Hold tænd/sluk-knappen nede i 3-5 sekunder for at tænde panelet.

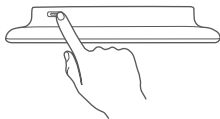



 Album

 Optag

 Indstillinger

Tryk på  for at konfigurere indstillingerne efter behov for visning, overvågning, dato osv.

Tilslut til wi-fi

1



2

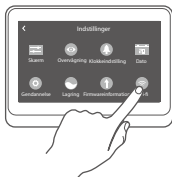

3

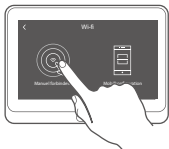

4



DK

Vælg det relevante wi-fi-netværk, og angiv din adgangskode.

Føj til EZVIZ-app

- 1 Opret en brugerkonto.
 - Slut din mobiltelefon til wi-fi-netværket.
 - Hent og installer appen EZVIZ ved at søge efter "EZVIZ" i App Store og Google Play™.
 - Start appen, og registrér en EZVIZ-brugerkonto ved at følge opstartsguiden.
- 2 Tilføj et kamera til EZVIZ.
 - Log ind på appen EZVIZ.
 - Tryk på "+" i øverste højre hjørne af startskærmen for at gå til siden til scanning af QR-koden.

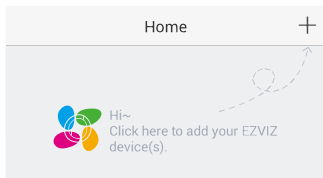

- Scan QR-koden.

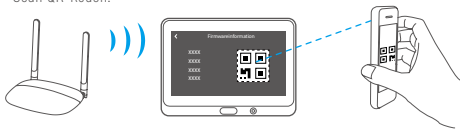

i Tryk på **Firmware info (Firmwareinformation)** for at få vist QR-koden.

Oplad panelet

Slut panelet til stikkontakten med strømadapteren.

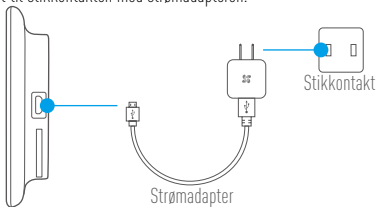

- Anbefalet opladningstid: 5-6 timer.
- Du kan også oplade panelet med den bærbare oplader, som hænges på krogen.

Huomio

- Älä altista kameraa ankarille ympäristöolosuhteille, kuten korkealle lämpötilalle, kosteudelle, suolasumulle tai sateelle, muutoin laite voi vaurioitua.
- Älä paina kameran anturia tai objektiivia, muutoin laite voi vaurioitua.
- Älä vedä kameran kaapelia liian kovaa, suojaa itsesi kaapelin aiheuttamilta viilloilta. Takuu ei korvaa kaapelin vaurioitumista epäasianmukaisen käytön takia.
- Käytä paneelin lataamiseen ainoastaan verkkolaitetta, muutoin järjestelmä voi vaurioitua.

Pakkauksen sisältö



Kamera (x1)



Paneeli (x1)



Asennuspohja (x1)



Ruuvit (x3)



Pohjan kiinnitin (x1)



Kaapelin kiinnitin (x1)



Kaapeli (x1)



Verkkolaite (x1)



Pika-aloitusopas (x1)

Yleiskatsaus

Paneeli

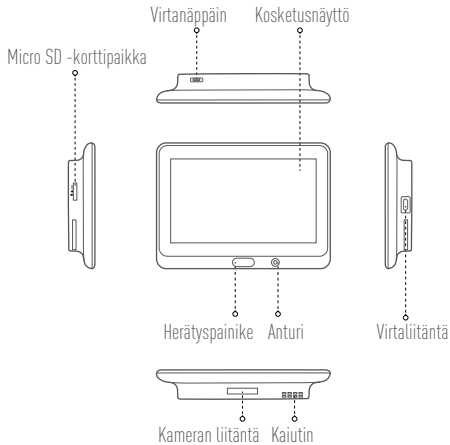

Kamera

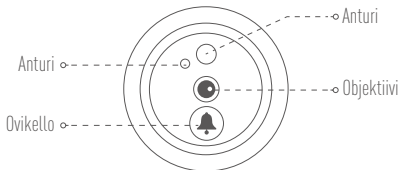

i Älä peitä antureita.

Asennuspohja

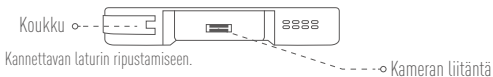
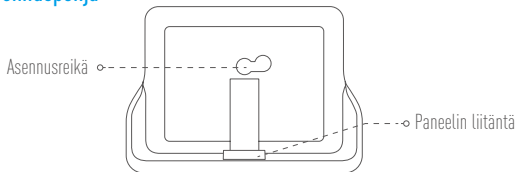

Asennus

- Jos olet asentanut ovisilmän, poista se ja asenna laite samaan paikkaan. Jos et ole, poraa halkaisijaltaan noin 16,5–30 mm:n reikä noin 145 cm:n korkeudelle maanpinnasta, jotta katselu onnistuu hyvin.

1



Mittaa oven paksuus ja valitse sopiva ruuvi.

Paksuus

35–60 mm

60–85 mm

85–100 mm

Ruuvi



2



Kierrä ruuvi kameran taakse.

3



Repäise suoja-paperi irti.

4



Vie ruuvi ja kaapeli oven läpi.
Voit pyörittää paperirullan avuksi.

5



Säädä kameran asento ja työnnä se varovasti kiinni oven.

6



Yhdistä asennuspohja
ja kameran kaapeli.

7



Aseta kiinnitin ja kiinnitä se painamalla tiiviisti.

FI

8



Säädä asennuspohjan asento ja kiristä ruuvi.

9



Laita kaapelit uraan ja työnä kiinnitin paikalleen.

10



Liu'uta paneeli asennuspohjaan.

11



Kytke paneeliin virta painamalla ja pitämällä virtapainiketta.

Virran kytkeminen päälle

Kytke paneeliin virta painamalla ja pitämällä virtapainiketta 3–5 sekunnin ajan.

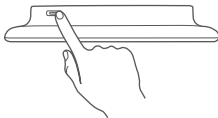



 Albumi

 Tallenna

 Aseta

Napauttamalla  voit asettaa haluamasi parametrit, kuten näytön, valvonnan, päivämäärän jne.

Wi-Fi-verkkoon yhdistäminen

1



2

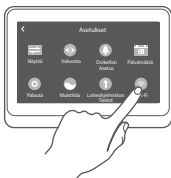

3



4



Valitse Wi-Fi-verkkosi ja anna salasana.

FI

Lisää EZVIZ-sovellukseen

- 1 Luo käyttäjätili.
 - Yhdistä matkapuhelimesi Wi-Fi-verkkoon.
 - Lataa ja asenna EZVIZ-sovellus hakemalla se "EZVIZ"-hakusanalla App Storesta tai Google Play™ -kaupasta.
 - Käynnistä sovellus ja rekisteröi EZVIZ-käyttäjätili ohjatun käyttöönoton ohjeita noudattamalla.
- 2 Lisää kamera EZVIZ-tiliin.
 - Kirjaudu EZVIZ-sovellukseen.
 - Siirry QR-koodin skannaussivulle napauttamalla aloitusnäytön oikeassa yläkulmassa olevaa "+"-symbolia.

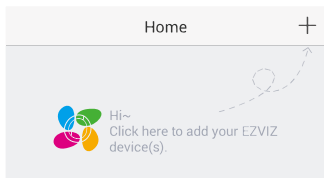

-Skannaa QR-koodi.

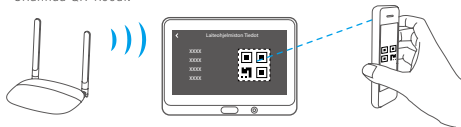

 Napauttamalla **Firmware Info (laiteohjelmiston tiedot)** näet QR-koodin.

Paneelin lataaminen

Yhdistä paneeli virtaliitäntään verkkolaitteen kautta.

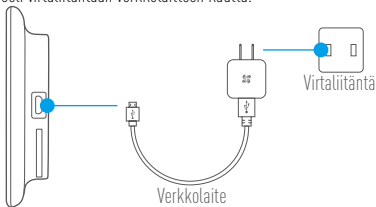

- i** • Suositeltu latausaika: 5–6 tuntia.
- Voit myös ladata paneelin kannettavalla laturilla, jonka voit ripustaa koukkuun.

LIMITED WARRANTY

Thank you for purchasing EZVIZ products. This limited warranty gives you, the original purchaser of the EZVIZ product, specific legal rights. You may also have other legal rights that vary by state, province or jurisdiction. The disclaimers, exclusions, and limitations of liability under this limited warranty will not apply to the extent prohibited by applicable law. No distributor, reseller, agent, or employee is authorized to make any medication, extension, or addition to this limited warranty.

Your EZVIZ product is warranted for a period of two (2) years from the date of purchase against defects in materials and workmanship, or such longer period as may be required by law in the country or state where this product is sold, when used normally in accordance with user manual.

You can request warranty service by emailing us at support.eu@ezvizlife.com.

For any defective EZVIZ products under warranty, HANGZHOU HIKVISION DIGITAL TECHNOLOGY CO., LTD. ("the Company") will, at its option, (i) repair or replace your product free of charge; (ii) exchange your product with a functional equivalent product; (iii) or refund the original purchase price, provided you provide the original purchase receipt or copy, brief explanation of the defect, and return the product in its original packaging. At the sole discretion of the Company, repair or replacement may be made with a new or refurbished product or components. This warranty does not cover the postal cost, insurance and any other incidental charges incurred by you in returning the product.

Except where prohibited by applicable law, this is your sole and exclusive remedy for breach of this limited warranty. Any product that has either been repaired or replaced under this limited warranty will be covered by the terms of this limited warranty for the longer of ninety (90) days from the date of delivery or the remaining original warranty period.

This warranty does not apply and is void:

- If the warranty claim is made outside the warranty period or if the proof of purchase is not provided.
- For any malfunction, defect or failure caused by or resulting from the evidence of impact, mishandling, tampering, use contrary to the applicable instruction manual, incorrect power line voltage, accident, loss, theft, fire, flood or other Acts of God, shipping damage or damage resulting from repairs performed by unauthorized personnel.
- For any consumable parts, such as batteries, where the malfunction is due to the normal aging of the product.
- Cosmetic damage, including but not limited to scratches, dents and broken plastic on ports.
- Any software, even if packaged or sold with EZVIZ hardware.
- For any other damages free from defects in material or workmanship.
- Routine cleaning, normal cosmetic and mechanical wear and tear.

Please do not hesitate to contact your seller, or send e-mails to us support.eu@ezvizlife.com, with any questions.

COPYRIGHT ©2018 HANGZHOU HIKVISION DIGITAL TECHNOLOGY CO., LTD. ALL RIGHTS RESERVED.

BESCHRÄNKTE GARANTIE

Vielen Dank für den Kauf eines EZVIZ-Produkts. Diese beschränkte Garantie gibt Ihnen, dem Erstkäufer des EZVIZ-Produkts, bestimmte gesetzliche Rechte. Je nach Staat, Provinz oder Land können Ihnen weitere gesetzliche Rechte zustehen. Die Haftungsausschlüsse und -beschränkungen gemäß dieser beschränkten Garantie gelten ausschließlich im gesetzlich zulässigen Umfang. Kein Händler, Wiederverkäufer, Vertreter oder Mitarbeiter ist befugt, Modifikationen, Erweiterungen oder Ergänzungen an dieser beschränkten Garantie vorzunehmen.

Ihr EZVIZ-Produkt wird für einen Zeitraum von zwei (2) Jahren ab Kaufdatum gegen Material- und Verarbeitungsfehler oder für einen längeren Zeitraum garantiert, der in dem Land, in dem dieses Produkt verkauft wird, gesetzlich vorgeschrieben ist, wenn es bestimmungsgemäß und gemäß der Bedienungsanleitung verwendet wird.

Garantieansprüche richten Sie bitte per E-Mail an support.eu@ezvizlife.com.

Im Fall eines defekten EZVIZ-Produkts mit gültiger Garantie wird HANGZHOU HIKVISION DIGITAL TECHNOLOGY CO., LTD. ("das Unternehmen") nach eigenem Ermessen (i) Ihr Produkt kostenlos reparieren oder ersetzen, (ii) Ihr Produkt gegen ein funktionsfähiges vergleichbares Produkt austauschen oder (iii) den ursprünglichen Kaufpreis unter der Voraussetzung erstatten, dass Sie das Produkt in dessen Originalverpackung unter Beigabe des Originalkaufbelegs oder einer Kopie davon sowie einer kurzen Beschreibung des Defekts zurückschicken. Das Unternehmen wird nach alleinigem Ermessen Produkte oder Komponenten entweder reparieren oder gegen neue oder generalüberholte Produkte oder Komponenten austauschen. Diese Garantie deckt keine Versand-, Versicherungs- oder sonstige Nebenkosten, die Ihnen durch die Rücksendung des Produkts entstehen.

Soweit nicht durch geltendes Recht untersagt, ist dies Ihr einziges und ausschließliches Rechtsmittel im Fall einer Verletzung dieser beschränkten Garantie. Jedes Produkt, das im Rahmen dieser beschränkten Garantie entweder repariert oder ausgetauscht wurde, wird für maximal neunzig (90) Tage ab Lieferdatum oder für die Restlaufzeit der ursprünglichen Garantie von den Bestimmungen dieser beschränkten Garantie abgedeckt.

Diese Garantie gilt nicht und ist hinfällig:

- wenn der Garantieanspruch außerhalb der Garantiefrist oder ohne Vorlage des Kaufbelegs geltend gemacht wird.
- bei Fehlfunktionen, Defekten oder Fehlern, die durch Stoßeinwirkung, Fehlbedienung, Sabotage, Benutzung im Widerspruch zur entsprechenden Bedienungsanleitung, falsche Spannungsversorgung, Unfall, Verlust, Diebstahl, Brand, Überschwemmung oder andere Naturkatastrophen, Versandschäden oder Beschädigungen infolge von Reparaturen durch unbefugte Personen verursacht wurden oder darauf zurückzuführen sind.
- für Verbrauchsgüter wie Batterien, bei denen die Fehlfunktion auf normale Produktalterung zurückzuführen ist.
- kosmetische Schäden, einschließlich, aber nicht begrenzt auf Kratzer, Beulen und gebrochene Kunststoffteile an Anschlüssen.
- für jede Software, auch wenn diese zusammen mit der EZVIZ-Hardware verpackt und verkauft wurde.
- für sonstige Schäden, die keine Material- oder Verarbeitungsfehler sind.
- für routinemäßige Reinigungen sowie normalen kosmetischen und mechanischen Verschleiß.

Bei Fragen können Sie sich jederzeit an Ihren Verkäufer oder per E-Mail an support.eu@ezvizlife.com an uns wenden.

COPYRIGHT ©2018 HANGZHOU HIKVISION DIGITAL TECHNOLOGY CO., LTD. ALLE RECHTE VORBEHALTEN.

GARANTÍA LIMITADA

Gracias por adquirir productos EZVIZ. Esta garantía limitada le concede a usted, el comprador original del producto EZVIZ, derechos legales específicos. Es posible que tenga otros derechos legales en función de su estado, provincia o jurisdicción. Los avisos de exención de responsabilidad, las exclusiones y las limitaciones de responsabilidad de esta garantía limitada no se aplicarán hasta el máximo prohibido por la legislación aplicable. Ningún distribuidor, revendedor, representante o empleado tiene autorización para introducir alteraciones, ampliaciones o incorporaciones en virtud de esta garantía limitada.

Su producto EZVIZ dispone de un periodo de garantía de dos (2) años a partir de la fecha de compra por defectos de material y fabricación, o de un periodo más largo si así lo exige la ley del país o el estado donde se vende el producto, en condiciones normales de uso según el manual del usuario.

Puede solicitar el servicio de garantía por correo electrónico en support.eu@ezvizlife.com.

Para cualquier producto de EZVIZ defectuoso en garantía, HANGZHOU HIKVISION DIGITAL TECHNOLOGY CO., LTD. ("la Empresa"), a su discreción, (I) reparará o sustituirá el producto de forma gratuita; (II) cambiará su producto por un producto equivalente funcional; (III) o reembolsará el precio de compra original, siempre y cuando proporcione el recibo de compra original o una copia, una breve descripción del defecto y devuelva el producto en su embalaje original. A la entera discreción de la Empresa, la reparación o la sustitución pueden realizarse por un producto o componentes nuevos o reacondicionados. Esta garantía no cubre el coste postal de transporte, el seguro ni ningún otro coste incidental en el que incurra durante la devolución del producto.

Excepto si lo prohíbe la legislación vigente, esta es la solución única y exclusiva en caso de incumplimiento de esta garantía limitada. Cualquier producto que se haya reparado o sustituido en virtud de esta garantía limitada estará cubierto por los términos de la misma durante el periodo máximo de noventa (90) días a partir de la fecha de entrega o el período de garantía original restante.

Esta garantía no se aplica y se considerará nula:

- Si la reclamación de garantía se realiza fuera del periodo de garantía o si no se proporciona la prueba de compra.
- En caso de funcionamiento incorrecto, defecto o avería causados por o como resultado de las pruebas de impacto, impericia, manipulación, uso contrario al manual de instrucciones aplicable, voltaje incorrecto de la línea eléctrica, accidente, pérdida, robo, incendio, inundación u otros actos de fuerza mayor, daños en el envío o daños ocasionados por reparaciones realizadas por personal no autorizado.
- En el caso de las piezas consumibles, como las baterías, si el funcionamiento incorrecto se debe al desgaste normal del producto.
- Daños cosméticos, incluidos, pero sin limitarse a, arañazos, abolladuras y plástico roto en puertos.
- Cualquier software, incluso si se ha incluido y vendido con el hardware de EZVIZ.
- En caso de otros daños libres de defectos en el material o la mano de obra.
- La limpieza rutinaria, cambios cosméticos y el desgaste mecánico natural.

Si tiene alguna pregunta, no dude en ponerse en contacto con su representante comercial, o bien envíenos un mensaje a support.eu@ezvizlife.com con la pregunta que desee.

COPYRIGHT ©2018 HANGZHOU HIKVISION DIGITAL TECHNOLOGY CO., LTD. RESERVADOS TODOS LOS DERECHOS.

GARANTIE LIMITÉE

Merci d'avoir acheté nos produits EZVIZ. En tant qu'acheteur original de produit EZVIZ, cette garantie limitée vous accorde certains droits. Selon le pays, la région ou la juridiction où vous résidez, il est possible que vous bénéficiez d'autres droits. Les dénis de responsabilités, exclusions et limitations de responsabilité civile stipulés dans cette garantie limitée s'appliquent uniquement dans les limites prévues par la loi. Aucun distributeur, revendeur, agent ou employé n'est autorisé à apporter de modification, d'extension ou d'ajout à cette garantie.

Votre produit EZVIZ est garanti pour une période de deux (2) ans à compter de la date d'achat, contre les défauts de matériaux et de fabrication, ou tout autre délai plus long prévu par la législation du pays ou de l'état où est vendu ce produit, à condition d'être utilisé de manière normale et conforme au manuel de l'utilisateur.

Pour faire valoir la garantie, écrivez-nous à l'adresse suivante: support.eu@ezvizlife.com.

Si un défaut est signalé sur un produit EZVIZ pendant la période de garantie, Hangzhou Hikvision Digital Technology Co., Ltd. (« la Société ») pourra, à sa discrétion, (i) réparer ou remplacer votre produit gratuitement ; (ii) remplacer votre produit par un produit équivalent en état de marche ; (iii) rembourser le prix d'achat. Vous devez toutefois présenter la preuve d'achat et une brève explication du défaut constaté, et renvoyer le produit dans son emballage d'origine. La Société pourra réparer ou remplacer le produit ou les composants par un produit ou des composants neufs ou remis en état. Cette garantie ne couvre pas les frais de port, l'assurance ni les éventuels frais annexes de renvoi du produit.

Sauf si la législation en vigueur l'interdit, cette garantie est votre seul et unique recours. Tout produit réparé ou remplacé en vertu de la présente garantie limitée sera couvert pendant une durée de quatre-vingt-dix (90) jours à compter de la date de livraison ou jusqu'à l'échéance de la période garantie originale.

Cette garantie ne s'applique pas et est considérée comme nulle dans les cas suivants :

- si l'utilisateur se prévaut de la garantie hors de la période de couverture ou s'il ne fournit pas de preuve d'achat.
- en cas de dysfonctionnement, de défaut ou de panne due ou induite par un choc, une mauvaise manipulation, un sabotage, une utilisation non conforme aux instructions du manuel, une tension d'alimentation incorrecte, un accident, une perte, un vol, un incendie, une inondation ou toute autre catastrophe naturelle, un préjudice subi pendant le transport ou résultant de réparations par un personnel non agréé ;
- consommables, tels que les batteries, où le dysfonctionnement est dû au vieillissement normal du produit ;
- dommages superficiels tels que, entre autres, les rayures, les bosses ou les pièces en plastique cassées ;
- logiciels, même fournis ou vendus avec le matériel EZVIZ ;
- préjudices autres que les défauts de pièces ou de main d'œuvre ;
- nettoyage de routine, vieillissement de l'aspect extérieur et usure mécanique normale.

Pour toute question, n'hésitez pas à contacter votre revendeur ou à nous écrire à l'adresse suivante: support.eu@ezvizlife.com.

COPYRIGHT ©2018 HANGZHOU HIKVISION DIGITAL TECHNOLOGY CO., LTD. TOUS DROITS RÉSERVÉS.

GARANZIA LIMITATA

Grazie per aver acquistato i prodotti EZVIZ. La presente garanzia limitata accorda all'acquirente originale del prodotto EZVIZ, specifici diritti legali. L'acquirente originale potrebbe godere anche altri diritti legali che variano da stato, provincia o giurisdizione. Le declinazioni di responsabilità, le esclusioni e le limitazioni di responsabilità ai sensi della presente garanzia limitata non si applicano ove espressamente vietate dalla legge applicabile. Nessun distributore, rivenditore, agente o dipendente è autorizzato a fornire rimedi, estensioni o aggiunte alla presente garanzia limitata.

Questo prodotto EZVIZ è coperto da garanzia contro difetti di materiali e lavorazione per un periodo di due (2) anni a partire dalla data di acquisto o per un periodo più lungo, ove richiesto dalla legge nel Paese o Stato in cui il prodotto è venduto, se usato normalmente attenendosi alle istruzioni contenute nel manuale dell'utente. Il servizio di assistenza in garanzia può essere richiesto via email, all'indirizzo support.eu@ezvizlife.com.

Per eventuali prodotti EZVIZ difettosi in garanzia, HANGZHOU HIKVISION DIGITAL TECHNOLOGY CO., Ltd. ("la Società"), avrà facoltà a sua discrezione di, (i) riparare o sostituire il prodotto a titolo gratuito; (ii) sostituire il vostro prodotto con un prodotto funzionalmente equivalente; (iii) o rimborsare il prezzo di acquisto originale, a fronte dell'esibizione della ricevuta di acquisto originale o in copia, una breve spiegazione del difetto e il reso del prodotto nella sua confezione originale. A esclusiva discrezione della Società, la riparazione o la sostituzione può avvenire con un prodotto o con dei componenti nuovi o ricondizionati. Questa garanzia non copre spese postali, assicurazione ed eventuali altre spese accessorie sostenute dall'acquirente per la restituzione del prodotto.

Salvo laddove proibito dalla legge applicabile, ciò costituisce l'unico ed esclusivo rimedio per la violazione della presente garanzia limitata. Qualsiasi prodotto riparato o sostituito ai sensi della presente garanzia limitata sarà coperto dai termini della presente garanzia limitata per il periodo di maggiore durata tra novanta (90) giorni dalla data di consegna o il periodo di garanzia originale residuo.

Questa garanzia non si applica e risulterà nulla:

- Se la richiesta di applicazione della garanzia perviene al di fuori del periodo di garanzia o se la prova di acquisto non viene fornita.
- Per qualsiasi malfunzionamento, difetto o guasto causato da, o confermato da prove di evidenza di, avvenuto impatto, uso improprio, manomissione, uso contrario alle istruzioni del relativo manuale, tensione di alimentazione errata, incidente, smarrimento, furto, incendio, inondazione o altre cause di forza maggiore, danni di spedizione o danni causati da riparazioni eseguite da personale non autorizzato.
- Per eventuali componenti consumabili, quali batterie, dove il mal funzionamento è dovuto al normale invecchiamento del prodotto.
- Danni estetici, inclusi ma non limitati a graffi, ammaccature e rotture delle plastiche delle porte.
- Qualsiasi software, anche se confezionato o venduto con hardware EZVIZ.
- Per eventuali altri danni esenti da difetti nei materiali o nella lavorazione.
- Pulizia ordinaria e il normale deterioramento estetico e meccanico.

Non esitate a contattare il venditore, o a inviarci un e-mail a support.eu@ezvizlife.com, per qualsiasi domanda.

COPYRIGHT ©2018 HANGZHOU HIKVISION DIGITAL TECHNOLOGY CO., LTD. TUTTI I DIRITTI RISERVATI.

BEPERKTE GARANTIE

Bedankt voor de aankoop van EZVIZ-producten. Met deze beperkte garantie worden u, de oorspronkelijke koper van het EZVIZ-product, specifieke juridische rechten verleend. Mogelijk heeft u ook andere rechten die verschillen per staat, provincie of rechtsgebied. De vrijwaringen, uitsluitingen en beperkingen van aansprakelijkheid in deze beperkte garantie zijn niet van toepassing voor zover dit is verboden door het toepasselijk recht. Geen enkele distributeur, wederverkoper, agent of werknemer is gemachtigd om deze beperkte garantie aan te passen, te verlengen of uit te breiden.

Uw EZVIZ-product is gegarandeerd tegen materiaal- en fabricagefouten voor een periode van twee (2) jaar vanaf de aankoopdatum, of een langere periode die wettelijk vereist is in het land of de staat waar dit product wordt verkocht, mits normaal gebruikt volgens de gebruikershandleiding.

U kunt garantieservice aanvragen door een e-mail te sturen naar support.eu@ezvizlife.com.

Voor defecte EZVIZ-producten die onder de garantie vallen, zal HANGZHOU HIKVISION DIGITAL TECHNOLOGY CO., LTD. ("het Bedrijf") naar eigen inzicht (i) het product gratis repareren of vervangen; (ii) het product omruilen voor een functioneel vergelijkbaar product; of (iii) de oorspronkelijke aankoopprijs restitueren nadat het oorspronkelijke aankoopbewijs of een kopie hiervan en een korte uitleg van het defect is aangeleverd, en het product is geretourneerd in de oorspronkelijke verpakking. Naar eigen inzicht van het Bedrijf zal de reparatie of vervanging plaatsvinden door nieuwe of gereviseerde producten of onderdelen te leveren. Deze garantie biedt geen dekking voor de verzendkosten, verzekeringskosten en andere incidentele kosten die u hebt moeten betalen voor het retourneren van het product.

Tenzij dit verboden is door het toepasselijk recht, is dit uw enige en exclusieve middel voor het verbreken van deze beperkte garantie. Producten die zijn gerepareerd of vervangen onder deze beperkte garantie, zijn gedekt onder de voorwaarden van deze beperkte garantie voor een periode van negentig (90) dagen) vanaf de datum van levering of voor de resterende duur van de oorspronkelijke garantie, waarbij de langste van deze twee perioden wordt aangehouden.

Deze garantie is niet van toepassing en wordt ongeldig verklaard:

- Als de garantieclaim buiten de garantieperiode wordt gedaan of als het aankoopbewijs niet wordt aangeleverd.
- In het geval van onjuist functioneren, defecten of fouten die aantoonbaar het gevolg zijn van stoten, onjuist gebruik, manipulatie, gebruik dat niet in lijn is met de instructies in de handleiding, een onjuiste voedingspanning, ongevallen, verlies, diefstal, brand, overstromingen of andere overmacht, verzendschade of schade die het gevolg is van reparaties die zijn uitgevoerd door niet-geautoriseerd personeel.
- Voor verbruiksonderdelen, zoals batterijen, waarbij het onjuist functioneren het gevolg is van normale veroudering van het product.
- Bij cosmetische schade, inclusief, maar niet beperkt tot krassen, deuken en gebroken plastic op de poorten.
- Voor software, zelfs wanneer deze is meegeleverd of verkocht bij de EZVIZ-hardware.
- Voor andere schade dan materiaal- en fabricagedefecten.
- Voor vervuiling door normaal gebruik, en normale cosmetische en mechanische slijtage.

Neem voor vragen contact op met de verkopende partij, of neem contact met ons op via support.eu@ezvizlife.com.

COPYRIGHT ©2018 HANGZHOU HIKVISION DIGITAL TECHNOLOGY CO., LTD. ALLE RECHTEN VOORBEHOUDEN.

OGRANICZONA GWARANCJA

Dziękujemy za zakup produktów EZVIZ. Niniejsza ograniczona gwarancja daje użytkownikowi, czyli oryginalnemu nabywcy produktu EZVIZ, określone prawa. Użytkownikowi mogą też przysługiwać inne prawa, które zależą od danego państwa, obszaru terytorialnego lub jurysdykcji. Zastrzeżenia, wyłączenia i ograniczenia odpowiedzialności wynikające z niniejszej ograniczonej gwarancji nie będą miały zastosowania w zakresie zabronionym przez obowiązujące prawo. Żaden dystrybutor, sprzedawca, przedstawiciel ani pracownik nie jest uprawniony do dokonywania jakichkolwiek zmian, rozszerzeń lub uzupełnień niniejszej ograniczonej gwarancji.

Gwarancja dotycząca produktu EZVIZ, obejmująca wady materiałów i wykonania, obowiązuje przez dwa (2) lata od daty zakupu lub dłuższy okres zależnie od przepisów obowiązujących w kraju lub regionie, w którym produkt jest sprzedawany, pod warunkiem, że produkt jest użytkowany zgodnie z podręcznikiem użytkownika.

Można wysłać do nas zgłoszenie gwarancyjne pocztą elektroniczną na adres support.eu@ezvizlife.com.

Dla wszelkich produktów EZVIZ objętych gwarancją, HANGZHOU HIKVISION DIGITAL TECHNOLOGY CO., LTD. („Firma”), według własnego uznania, (i) bezpłatnie naprawi lub wymieni produkt; (ii) zamieni produkt na inny o porównywalnej funkcjonalności; (iii) zwróci użytkownikowi pierwotną cenę zakupu pod warunkiem przedstawienia oryginału lub kopii dowodu zakupu, krótkiego opisu usterki oraz zwrotu produktu w oryginalnym opakowaniu. Według wyłącznego uznania Firmy, naprawa lub wymiana może przeprowadzona z wykorzystaniem nowego lub regenerowanego produktu lub części. Niniejsza gwarancja nie obejmuje kosztu przesyłki, ubezpieczenia i innych dodatkowych opłat poniesionych przez użytkownika w związku ze zwrotem produktu.

Z wyjątkiem przypadków zabronionych przez obowiązujące prawo, powyższe warunki stanowią jedyny i wyłączny środek rekompensaty za naruszenie niniejszej ograniczonej gwarancji. Każdy produkt naprawiony lub wymieniony na podstawie niniejszej ograniczonej gwarancji będzie objęty jej warunkami przez czas pozostały do wygaśnięcia okresu pierwotnej gwarancji lub przez dziewięćdziesiąt (90) dni, zależnie od tego, który okres będzie dłuższy.

Niniejsza gwarancja nie obowiązuje i zostaje unieważniona:

- Jeśli zgłoszenie z tytułu gwarancji zostanie wniesione po upływie okresu gwarancji lub jeśli użytkownik nie dostarczy dowodu zakupu.
- W przypadku jakiegokolwiek awarii lub usterki spowodowanej przez lub wynikającej z wyraźnie widocznego uderzenia, nieprawidłowej obsługi, próby manipulacji, stosowania niezgodnie z instrukcją, nieprawidłowego napięcia zasilania, wypadku, zgubienia, kradzieży, pożaru, powodzi lub innych klęsk żywiołowych, szkód transportowych lub spowodowanych naprawą przez nieupoważniony personel.
- W przypadku wszelkich części eksploatacyjnych, takich jak baterie, których usterka wynika z normalnego starzenia się produktu.
- W przypadku szkód kosmetycznych, m.in. zarysowań, wgłęci i pękniętych plastikowych części portów.
- W przypadku jakiegokolwiek oprogramowania, nawet jeśli jest ono dołączone lub sprzedawane ze sprzętem EZVIZ.
- W przypadku innych szkód niewynikających z wad materiałowych lub wykonawstwa.
- W przypadku standardowego czyszczenia, oraz typowego zużycia kosmetycznego i mechanicznego.

Jeśli mają Państwo jakiekolwiek pytania, prosimy o kontakt ze sprzedawcą lub przesłanie ich do nas pocztą elektroniczną na adres support.eu@ezvizlife.com.

COPYRIGHT ©2018 HANGZHOU HIKVISION DIGITAL TECHNOLOGY CO., LTD. WSZELKIE PRAWA ZASTRZEŻONE.

ΠΕΡΙΟΡΙΣΜΕΝΗ ΕΓΓΥΗΣΗ

Σας ευχαριστούμε για την αγορά των προϊόντων EZVIZ. Η παρούσα περιορισμένη ευθύνη παρέχει σε εσάς, τον αρχικό αγοραστή του προϊόντος EZVIZ, ειδικά νομικά δικαιώματα. Ενδέχεται να έχετε κι άλλα νομικά δικαιώματα που ποικίλλουν ανάλογα με το κράτος, την περιοχή ή τη δικαιοδοσία σας. Οι αποποιήσεις, εξαιρέσεις και περιορισμοί ευθύνης βάσει της παρούσας περιορισμένης εγγύησης δεν ισχύουν στον βαθμό που απαγορεύεται από το εφαρμοστέο δίκαιο. Κανένας διανομέας, μεταπωλητής, αντιπρόσωπος ή εργαζόμενος δεν είναι εξουσιοδοτημένος να προβεί σε οποιαδήποτε τροποποίηση, επέκταση ή προσθήκη στην παρούσα περιορισμένη εγγύηση.

Το προϊόν EZVIZ σας διαθέτει εγγύηση για περίοδο δύο (2) ετών από την ημερομηνία αγοράς, σχετικά με ατέλειες στα υλικά και την κατασκευή ή για μεγαλύτερο χρονικό διάστημα, όπως απαιτείται βάσει του νόμου στη χώρα ή το κράτος όπου αγοράστηκε το προϊόν, εφόσον το προϊόν χρησιμοποιείται κανονικά, σύμφωνα με το εγχειρίδιο χρήσης.

Μπορείτε να υποβάλετε αίτηση για επίσκεψη στο πλαίσιο της παρούσας εγγύησης, στέλνοντάς μας e-mail στη διεύθυνση support.eu@ezvizlife.com.

Για τυχόν ελαττωματικά προϊόντα EZVIZ που καλύπτονται από εγγύηση, η εταιρεία HANGZHOU HIKVISION DIGITAL TECHNOLOGY CO., LTD. ("η Εταιρεία"), κατά την προαίρεσή της, (i) θα επισκευάσει ή αντικαταστήσει το προϊόν σας δωρεάν, (ii) θα ανταλλάξει το προϊόν σας με ένα αντίστοιχο λειτουργικό προϊόν ή (iii) θα επιστρέψει το αντίτιμο της αρχικής τιμής αγοράς, με την προϋπόθεση ότι θα προσκομίσετε την πρωτότυπη απόδειξη αγοράς ή αντίγραφο αυτής με σύντομη επεξήγηση του ελαττώματος του προϊόντος και ότι θα επιστρέψετε το προϊόν στην αρχική του συσκευασία. Κατά τη διακριτική ευχέρεια της Εταιρείας, η επίσκεψη ή η αντικατάσταση ενδέχεται να πραγματοποιηθεί με νέο ή επισκευασμένο προϊόν ή εξαρτήματα. Η παρούσα εγγύηση δεν καλύπτει ταχυδρομικά έξοδα, ασφάλιση ή άλλες παρεπόμενες δαπάνες, με τις οποίες θα επιβαρυνθείτε κατά την επιστροφή τους προϊόντος.

Εκτός αν απαγορεύεται από το εφαρμοστέο δίκαιο, αυτό είναι το μόνο και αποκλειστικό σας ένδικο μέσο σε περίπτωση παραβίασης της παρούσας περιορισμένης εγγύησης. Οποιοδήποτε προϊόν έχει επισκευαστεί ή αντικατασταθεί δυνάμει της παρούσας περιορισμένης ευθύνης καλύπτεται από τους όρους αυτής της περιορισμένης εγγύησης είτε για διάστημα ενενήντα (90) ημερών από την ημερομηνία παράδοσης, είτε για την εναπομένονσα αρχική περίοδο εγγύησης, όποιο είναι μεγαλύτερο. Η παρούσα εγγύηση δεν ισχύει ή θεωρείται άκυρη:

- Εάν η αξίωση εγγύησης εγερθεί εκτός της περιόδου εγγύησης ή σε περίπτωση μη προσκόμισης του αποδεικτικού αγοράς.
- Για οποιαδήποτε δυσλειτουργία, ελάττωμα ή βλάβη που προκληθεί από ή οφείλεται σε εμφανή πρόσκρουση, κακό χειρισμό, παραποίηση, χρήση αντίθετη με το σχετικό εγχειρίδιο οδηγιών, εσφαλμένη τάση τροφοδοσίας, ατύχημα, αλώβεια, κλοπή, πυρκαγιά, πλημμύρα ή λοιπές θεομηνίες, βλάβη κατά την αποστολή ή ζημιά που απορρέει από επισκευές που πραγματοποιήθηκαν από μη εξουσιοδοτημένο προσωπικό.
- Για οποιαδήποτε αναλώσιμα εξαρτήματα, όπως οι μπαταρίες, η δυσλειτουργία των οποίων οφείλεται στη κανονική χρήση του προϊόντος με την πάροδο του χρόνου.
- Για αισθητικές ζημιές, συμπεριλαμβανομένων, μεταξύ άλλων, γρατσουνιών, βαθουλωμάτων και σπασμένων πλαστικών στις θύρες.
- Για οποιοδήποτε λογισμικό, ακόμη κι αν συσκευάστηκε ή πωλήθηκε μαζί με το υλικό της EZVIZ.
- Για οποιαδήποτε άλλη βλάβη που δεν οφείλεται σε ελαττώματα σε υλικά και στην ποιότητα κατασκευής.
- Για συνθήκη καθαρισμό, φυσιολογική αισθητική και μηχανική φθορά.

Για τυχόν ερωτήσεις, μη διαστάσετε να επικοινωνήσετε με το κατάστημα πώλησης ή να μας στείλετε e-mail στη διεύθυνση support.eu@ezvizlife.com.

ΠΙΝΕΥΜΑΤΙΚΑ ΔΙΚΑΙΩΜΑΤΑ ©2018 HANGZHOU HIKVISION DIGITAL TECHNOLOGY CO., LTD. ΜΕ ΤΗΝ ΕΠΙΦΥΛΑΞΗ ΠΑΝΤΟΣ ΔΙΚΑΙΩΜΑΤΟΣ.

OMEZENÁ ZÁRUKA OMEZENÁ ZÁRUKA

Děkujeme, že jste zakoupili výrobek EZVIZ. Tato omezená záruka vám, původnímu kupujícímu výrobku EZVIZ, dává specifická zákonná práva. Můžete mít i další práva, která se liší podle státu, provincie nebo jurisdikce. Odmítnutí, výjimky a omezení odpovědnosti v rámci této omezené záruky platí jen v rozsahu daném příslušným zákonem. Žádný distributor, prodejce, zástupce nebo zaměstnanec není oprávněn provádět žádné úpravy, rozšíření nebo dodatky k této omezené záruce.

Produkt EZVIZ je po dobu dvou (2) let od data zakoupení (nebo po delší období, které může být vyžadováno zákonem v dané zemi nebo ve státě, kde je tento produkt prodáván) kryt zárukou na vady materiálu a zpracování při běžném používání v souladu s návodem k použití.

O záruční servis můžete požádat na této e-mailové adrese support.eu@ezvizlife.com.

V případě jakéhokoliv vadného produktu EZVIZ v záruce, společnost HANGZHOU HIKVISION DIGITAL TECHNOLOGY CO., LTD. (dále jen „společnost“) podle svého uvážení, (i) opraví nebo vymění výrobek zdarma; (ii) nahradí výrobek za ekvivalentní funkční výrobek; (iii) nebo vrátí původní kupní cenu, pokud poskytnete originální doklad o koupi nebo jeho kopii, stručný popis závady a výrobek vrátíte v původním balení.

Na základě vlastního uvážení společnosti výrobek může být opraven nebo nahrazen novým nebo modernizovaným výrobkem nebo komponenty. Tato záruka se nevztahuje na poštovní náklady, pojištění a další dodatečné poplatky, které vám vznikly při vrácení výrobku.

Kromě případů daných příslušným zákonem je toto vaší jedinou a výhradní náhradou za porušení závazků této omezené záruky. Na každý výrobek, který byl buď opraven nebo vyměněn v rámci této omezené záruky se vztahuje tato omezená záruka po dobu devadesáti (90) dnů ode dne doručení nebo po dobu zbývající původní záruční doby.

Tato záruka neplatí a nevztahuje se:

- Je-li záruční reklamáce uskutečněna mimo záruční dobu, nebo v případě, že není poskytnut doklad o koupi.
- Na jakékoli poruchy, závady nebo selhání způsobené nárazem, nesprávnou manipulací, narušením, používáním výrobku v rozporu s platným návodem, nesprávným elektrickým napětím, nehodou, ztrátou, odcizením, požárem, povodní nebo jinými zásahy vyšší moci, poškozením při přepravě nebo poškozením v důsledku oprav prováděných neoprávněnými osobami.
- Na jakékoli spotřební díly, jako jsou baterie, kde závada je způsobena normálním stárnutím produktu.
- Kosmetické poškození, mimo jiné na poškrábání, promáčknutí a zlomené plasty na portech.
- Jakýkoliv software a to i v případě, že byl součástí produktu nebo prodáván spolu s hardwarem EZVIZ.
- Na jakékoli jiné poškození bez vad na materiálu nebo zpracování.
- Normální kosmetické a mechanické opotřebení, opotřebení v důsledku pravidelného čištění.

S případnými dotazy se prosím obraťte se na svého prodejce nebo pošlete e-mail na adresu support.eu@ezvizlife.com.

COPYRIGHT ©2018 HANGZHOU HIKVISION DIGITAL TECHNOLOGY CO., LTD. VŠECHNA PRÁVA VYHRAZENA.

OBMEDZENÁ ZÁRUKA

Ďakujeme za zakúpenie produktov EZVIZ. Táto obmedzená záruka vám ako originálnemu kupujúcemu produktu EZVIZ zaručuje špecifické zákonné práva. Môžete mať aj iné zákonné práva, ktoré sa líšia v závislosti od štátu, kraja alebo jurisdikcie. Zrieknutie sa zodpovednosti, vylúčenie a obmedzenie zodpovednosti v rámci tejto obmedzenej záruky sa nevzťahuje na rozsah, ktorý je zakázaný platnými zákonmi. Žiaden distribútor, predajca, zástupca ani zamestnanec nie je oprávnený robiť žiadne úpravy, rozšírenie, ani doplnenie tejto obmedzenej záruky.

Váš produkt EZVIZ je v záručnej lehote po dobu dvoch (2) rokov od dátumu zakúpenia v prípade chyby materiálu a spracovania alebo dlhšieho obdobia, ktoré môžu požadovať zákony v krajine alebo štáte, kde sa tento produkt predáva, keď sa používa bežne v súlade s návodom na použitie.

O záručný servis môžete požiadať odoslaním e-mailu na adresu support.eu@ezvizlife.com.

V prípade akýchkoľvek chybných produktov EZVIZ v záruke spoločnosť HANGZHOU HIKVISION DIGITAL TECHNOLOGY CO., LTD. („spoločnosť“) podľa vlastného uváženia vykoná (i) bezplatnú opravu alebo výmenu produktu; (ii) výmenu produktu za funkčný ekvivalentný produkt; (iii) prípadne vráti pôvodnú kúpnu cenu za predpokladu, že poskytnete pôvodný doklad o kúpe alebo jeho kópiu, stručné vysvetlenie poruchy a vrátite produkt v pôvodnom balení. Na základe vlastného uváženia spoločnosti môže byť oprava alebo výmena vykonaná použitím nového alebo renovovaného produktu alebo komponentov. Táto záruka sa nevzťahuje na poštovné, poistenie a akékoľvek ďalšie vedľajšie náklady, ktoré vznikli pri vrátení produktu.

S výnimkou prípadov, keď to príslušné zákony zakazujú, je to váš výlučný a výhradný opravný prostriedok v prípade porušenia tejto obmedzenej záruky. Na každý produkt, ktorý bol opravený alebo vymenený v rámci tejto obmedzenej záruky, sa budú vzťahovať podmienky tejto obmedzenej záruky počas deväťdesiatich (90) dní od dátumu doručenia alebo počas zostávajúcej pôvodnej záručnej doby podľa toho, ktorá obdoba je dlhšie.

Táto záruka neplatí a nevzťahuje sa na nasledujúce prípady:

- Ak sa nárok na záruku uskutočňuje mimo záručnej doby alebo ak nie je predložený dôkaz o zakúpení.
- V prípade akejkoľvek nefunkčnosti, chyby alebo poruchy spôsobenými nárazom, nesprávnym používaním, neoprávneným zasahovaním, používaním v rozpore s príslušným návodom na používanie, nesprávnym napätím elektrickej siete, nehodou, stratou, krádežou, požiarom, záplavou, alebo inými neočakávanými udalosťami, poškodením pri preprave, alebo poškodením spôsobeným opravami vykonanými neoprávneným personálom, alebo ich v prípade ich dôsledkov.
- V prípade spotrebných súčastí, ako sú napr. batérie, pri ktorých je nefunkčnosť spôsobená bežným starnutím produktu.
- Vizúálne poškodenie vrátane, avšak bez obmedzenia na škrabance, zárezy a zlomené plastové časti portov.
- Akýkoľvek softvér, aj keď sa dodáva alebo predáva s hardvérom EZVIZ.
- V prípade akýchkoľvek iných škôd bez poškodenia materiálu alebo spracovania.
- Rutinné čistenie, bežné vizuálne a mechanické opotrebovanie.

Ak máte akékoľvek otázky, neváhajte a obráťte sa na predajcu alebo nám odošlite e-mail na adresu support.eu@ezvizlife.com.

AUTORSKÉ PRÁVA ©2018 HANGZHOU HIKVISION DIGITAL TECHNOLOGY CO., LTD. VŠETKY PRÁVA VYHRADENÉ.

BEGRENSET GARANTI

Takk for at du har kjøpt et EZVIZ-produkt. Denne begrensede garantien gir deg, den opprinnelige kjøper av EZVIZ-produktet, spesifikke lovfestede rettigheter. Du kan også ha andre lovfestede rettigheter som varierer med stat, provins eller domsmakt. Ansvarsfraskrivelsene, utelukkelsene og ansvarsbegrensningene i denne begrensede garantien gjelder ikke i den grad det er forbudt i henhold til gjeldende lov. Ingen distributør, forhandler, agent eller ansatt er autorisert til å gjøre noen endring, utvidelse eller tillegg til denne begrensede garantien.

Ditt EZVIZ-produkt har garanti for defekter i materialer og utførelse. Garantien er gyldig enten i to (2) år fra kjøpsdatoen eller i en lengre periode hvis dette er lovpålagt der produktet blir solgt. Garantien er kun gyldig hvis produktet brukes på normal måte og i samsvar med brukerhåndboken.

Du kan be om garantiservice ved å sende en e-post til support.eu@ezvizlife.com.

For eventuelle defekte EZVIZ-produkter under garanti, HANGZHOU HIKVISION DIGITAL TECHNOLOGY CO., LTD. ("Selskapet") vil, etter eget valg, (i) reparere eller erstatte produktet kostnadsfritt; (ii) bytte produktet med et funksjonelt ekvivalent produkt; (iii) eller refundere den opprinnelige kjøpesummen, forutsatt at du kan fremskaffe originalkvitteringen eller en kopi, gi en kort beskrivelse av feilen og returnere produktet i originalemballasjen. Etter eget skjønn kan selskapet reparere eller erstatte produktet eller komponenter med et nytt eller overhålt produkt eller komponenter. Denne garantien dekker ikke fraktkostnaden, forsikringen og eventuelle andre tilleggskostnader som påløper deg ved retur av produktet.

Med unntak av det som er forbudt i henhold til gjeldende lov, er dette ditt eneste rettsmiddel for brudd på denne begrensede garantien. Ethvert produkt som enten er reparert eller erstattet under denne begrensede garantien, vil bli dekket av vilkårene i denne begrensede garantien for en periode på nitti (90) dager fra leveringsdato eller gjenværende originale garantiperiode.

Denne garantien gjelder ikke, og er ugyldig:

- Hvis garantikravet er gjort utenfor garantiperioden, eller hvis kjøpsbevis ikke kan fremskaffes.
- For funksjonsfeil, mangler eller feil som forårsakes av, eller skyldes synlige bevis for slag, mishandling, sabotasje, bruk i strid med gjeldende brukerhåndbok, feil spenning på strømmettet, ulykke, tap, tyveri, brann, flom eller force majeure, transportskade eller skade som følge av reparasjoner utført av uautorisert personale.
- For eventuelle forbruksdeler, som f.eks. batterier, der feilen skyldes normal aldring av produktet.
- Kosmetisk skade, inkludert, men ikke begrenset til riper, hakk og ødelagt plast på porter.
- All programvare, selv om den er pakket eller solgt med EZVIZ-maskinvare.
- For eventuelle andre skader som ikke skyldes feil i materiale eller utførelse.
- Rutinemessig rengjøring, normal kosmetisk og mekanisk slitasje.

Ikke nøl med å kontakte selgeren, eller send e-post til oss med eventuelle spørsmål på support.eu@ezvizlife.com.

COPYRIGHT ©2018 HANGZHOU HIKVISION DIGITAL TECHNOLOGY CO., LTD. MED ENERETT.

BEGRÄNSAD GARANTI

Tack för att du köper produkter från EZVIZ. Den här begränsade garantin ger specifika juridiska rättigheter till den person som ursprungligen köpte EZVIZ-produkten. Du kan även ha andra juridiska rättigheter, beroende på delstat, region eller jurisdiktion. De friskrivningar, undantag och begränsningar av ansvar i denna begränsade garanti gäller inte i den mån de är förbjudna enligt tillämplig lagstiftning. Ingen distributör, återförsäljare, agent eller anställd har rätt att göra någon form av korrigerig, utökande eller tillägg i denna begränsade garanti.

Din EZVIZ-produkt har en garantiperiod på två (2) år från tillverkningsdatum för material- och tillverkningsfel, eller sådan längre period som kan krävas av lagstiftning i det land eller stat där denna produkt säljs, vid normal användning i enlighet med bruksanvisningen.

Om du vill göra garantianspråk skickar du e-post till oss på följande adress: support.eu@ezvizlife.com.

För alla defekta EZVIZ-produkter med giltig garanti kommer HANGZHOU HIKVISION DIGITAL TECHNOLOGY CO., LTD. ("Företaget") efter eget gottfinnande antingen att (i) reparera eller byta ut produkten utan kostnad; (ii) byta ut produkten mot en produkt med motsvarande funktion; (iii) eller återbetala det belopp som ursprungligen betalats för produkten, under förutsättning att du tillhandahåller inköpskvittot i original eller en kopia tillsammans med en kortfattad förklaring av felet och returnerar produkten i originalförpackningen. Reparationen eller bytet kan, efter Företagets eget gottfinnande, göras med nya eller renoverade produkter eller komponenter. Garantin omfattar inte fraktkostnader, försäkring och andra oförutsedda utgifter som uppstår till följd av returen av produkten.

Förutom på platser där detta är förbjudet enligt tillämplig lagstiftning, är detta är din enda ersättning för brott mot denna begränsade garanti. Alla produkter som har antingen reparerats eller byts ut inom ramarna för denna begränsade garanti omfattas av villkoren i den begränsade garantin i den längsta av antingen en period på nittio (90) dagar från leveransdatum eller den ursprungliga garantitiden.

Garantin gäller inte i följande fall, då den är ogiltig:

- Om garantianspråket görs efter att garantitiden har gått ut eller om inköpsbevis inte kan presenteras.
- Vid felfunktion, defekter eller fel som orsakats av eller uppstått till följd av stötar, felaktig hantering, manipulering, användning som strider mot tillhörande bruksanvisning, felaktig spänningsmatning, olyckor, förlust, stöld, eldsvåda, översvämning eller annan force majeure, leveransskador eller skador som uppstått till följd av reparationer som har utförts av obehörig personal.
- För förbrukningsdelar, till exempel batterier, där defekten är ett resultat av normalt åldrande av produkten.
- För skönhetsfel inklusive, men inte begränsat till, repor, bucklor och trasig plast på portar.
- För programvara, även om den förpackats eller sålts med maskinvara från EZVIZ.
- För alla andra skador utöver defekter i material eller utförande.
- För normalt slitage, normala skönhetsfel och mekaniskt slitage.

Tveka inte att kontakta din säljare eller skicka ett e-postmeddelande till support.eu@ezvizlife.com om du har några frågor.

COPYRIGHT ©2018 HANGZHOU HIKVISION DIGITAL TECHNOLOGY CO., LTD. MED ENSAMRÄTT.

BEGRÆNSET GARANTI

Tak fordi du har valgt EZVIZ-produkter. Denne begrænsede garanti giver dig, den oprindelige køber af EZVIZ-produktet, specifikke juridiske rettigheder. Du kan også have andre rettigheder, der varierer fra stat til stat, område eller jurisdiktion. Ansvarsfraskrivelser, udelukkelse og begrænsninger af ansvaret under denne begrænsede garanti gælder ikke i det omfang, som er forbudt af gældende lov. Ingen distributør, forhandler, agent eller medarbejder er autoriseret til at foretage ændringer eller udvide eller tilføje betingelser til denne begrænsede garanti.

Dit EZVIZ-produkt er dækket af en garanti mod fejl i materialer og fremstilling i to (2) år fra købsdatoen eller i en længere periode, hvis dette kræves ved lov i landet, hvor produktet sælges, når produktet bruges normalt i overensstemmelse med brugervejledningen.

Du kan anmode om service under garanti ved at sende en e-mail til følgende e-mail-adresse: support.eu@ezvizlife.com.

For alle defekte EZVIZ-produkter vil HANGZHOU HIKVISION DIGITAL TECHNOLOGY CO., LTD. ("Selskabet") i garantiperioden efter eget valg (i) reparere eller erstatte produktet uden beregning; (ii) ombytte produktet med et produkt med tilsvarende funktion; (iii) eller refundere den oprindelige købspris, såfremt du fremsender den originale købskvittering eller en kopi sammen med en kort beskrivelse af defekten, og returnerer produktet i den originale emballage. Produktet kan, efter Selskabets eget skøn, repareres eller udskiftes med et nyt eller brugt produkt eller nye eller brugte komponenter. Garantien dækker ikke udgifter for fragt, forsikring og yderligere udgifter, som opstår i forbindelse med returnering af produktet.

Medmindre det ikke er tilladt under gældende lovgivning, er dette dit eneste retsmiddel i tilfælde af overtrædelser af denne begrænsede garanti. Alle produkter, som er blevet repareret eller udskiftet i henhold til denne begrænsede garanti, vil være omfattet af bestemmelserne i denne begrænsede garanti i halvfems (90) dage fra leveringsdatoen eller i den resterende oprindelige garantiperiode.

Denne garanti gælder ikke i følgende tilfælde og bliver ugyldig:

- Hvis et garantikrav bliver fremsat efter at garantiperioden er udløbet eller hvis købsbeviset ikke kan blive fremvist.
- Ved enhver fejl, defekt eller mangel, som er forårsaget af eller er opstået som følge af stød, forkert håndtering, manipulering, anvendelse som ikke er i overensstemmelse med produktanvisningerne, tilslutning til forkert netspænding, uheld, tab, tyveri, brand, oversvømmelse eller andre naturkatastrofer, transportskade eller skade som skyldes uautoriserede reparationer.
- For alle forbrugsvarer, som f.eks. batterier, hvor fejlen skyldes normal ældning af produktet.
- Kosmetiske skader, herunder men ikke begrænset til, ridser, buler og knækket plastik på porte.
- For software, selvom den er emballeret eller solgt med EZVIZ-hardware.
- For alle andre skader, der er fri for defekter i materiale eller udførelse.
- Regelmæssig rengøring, normale kosmetiske fejl og mekanisk slitage.

Tøv ikke med at kontakte din forhandler eller sende en e-mail til support.eu@ezvizlife.com, hvis du har spørgsmål.

COPYRIGHT ©2018 HANGZHOU HIKVISION DIGITAL TECHNOLOGY CO., LTD. ALLE RETTIGHEDER FORBEHOLDNES.

RAJOITETTU TAKUU

Kiitos, että ostit EZVIZ-tuotteita. Tämä rajoitettu takuu antaa sinulle, EZVIZ-tuotteen alkuperäiselle ostajalle, erityiset lailliset oikeudet. Sinulla voi olla myös muita laillisia oikeuksia, jotka vaihtelevat osavaltion, provinssin tai hallintoalueen mukaan. Tämän rajoitetun takuun alaisia vastuuvapauslausekkeita ja vastuurajoituksia ei sovelleta siinä määrin kuin sovellettavissa oleva laki estää. Maahantuojilla, jälleenmyyjillä, edustajilla tai työntekijöillä ei ole oikeutta tehdä mitään muutoksia, laajennuksia tai lisäyksiä tähän rajoitettuun takuuseen.

EZVIZ-tuotteellasi on kahden (2) vuoden takuu ostopäivästä alkaen materiaali- tai valmistusvirheiden varalta edellyttäen, että laitetta on käytetty normaalisti ja käyttöoppaan mukaisesti, takuuakausi voi olla pidempi, jos tuotteen myyntimaan lainsäädäntö niin vaatii.

Voit pyytää takuuhuoltoa lähettämällä sähköpostia osoitteeseen support.eu@ezvizlife.com.

Takuunalaisten viallisten EZVIZ-tuotteiden yhteydessä HANGZHOU HIKVISION DIGITAL TECHNOLOGY CO., LTD. ("yritys") valintansa mukaan (i) korjaa tai vaihtaa tuotteen maksuttomasti, (ii) vaihtaa tuotteen toimivaan vastaavaan tuotteeseen (iii) tai palauttaa alkuperäisen ostohinnan sillä edellytyksellä, että käyttäjä toimittaa alkuperäisen ostokuitin tai kopion siitä ja lyhyen selityksen viasta sekä palauttaa tuotteen alkuperäisessä pakkauksessaan. Yrityksen omaa harkintavaltaa käyttäen tuotteen korjaus tai vaihto voidaan tehdä uusilla tai kunnostetuilla tuotteilla tai komponenteilla. Tämä takuu ei kata postikuluja, vakuutusta ja mitään muita tuotteen palautuksesta johtuvia satunnaisia kuluja.

Lukuun ottamatta tilanteita, joissa sovellettava laki estää sen, tämä on ostajan ainoa hyötys tämän rajoitetun takuun puitteissa. Tämän rajoitetun takuun alaisena korjattu tai vaihdettu tuote on tämän rajoitetun takuun kattama vähintään yhdeksänkymmenen (90) päivän ajan toimituspäivästä alkaen tai alkuperäisen takuujakson loppuajan.

Tämä takuu ei kata seuraavia kohtia:

- Jos takuuvaatimus tehdään takuujakson ulkopuolella tai jos ostotodistusta ei toimiteta.
- Iskusta, väärinkäytöstä, muuttamisesta, sovellettavan käyttöohjeen vastaisesta käytöstä, virheellisestä voimansiirtolinjan jännitteestä, onnettomuudesta, häviämisestä, varkaudesta, tulipalosta, tulvasta tai muista luonnonmullistuksista johtuva häiriö, vika tai toimintahäiriö, kuljetusvahinko tai valtuuttamattoman huoltohenkilöstön tekemistä korjauksista johtuva vaurio.
- Kuluvat osat, kuten paristot, joissa toimintahäiriö johtuu tuotteen normaalista vanhenemisestä.
- Kosmeettinen vaurio, mukaan lukien, muttei niihin rajoittuen, naarmut, lommot ja porttien rikkoutuneet muoviosat.
- Ohjelmistot, vaikka ne olisivat pakattuja tai myytyjä EZVIZ-laitteiston kanssa.
- Kaikki muut vauriot, jotka eivät johdu materiaaleista tai työnlaadusta.
- Tavanomainen puhdistus, normaali kosmeettinen ja mekaaninen kuluminen.

Jos sinulla on kysyttävää, ota yhteyttä tuotteen myyjään tai lähetä meille sähköpostia osoitteeseen support.eu@ezvizlife.com.

COPYRIGHT ©2018 HANGZHOU HIKVISION DIGITAL TECHNOLOGY CO., LTD. KAIKKI OIKEUDET PIDÄTETÄÄN.



UD12069B