

Construction is made from stainless and galvanized steel metal and HPL laminate.

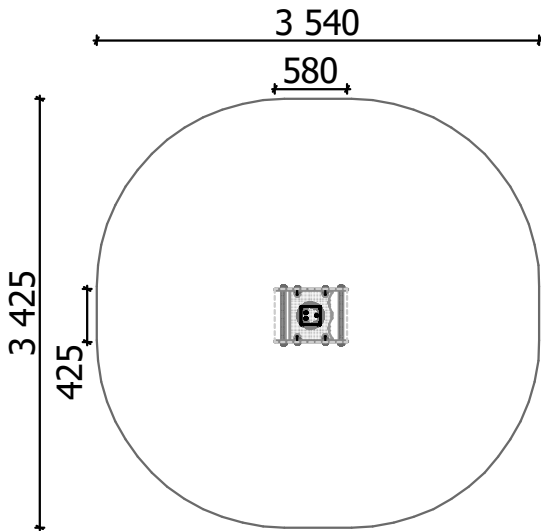
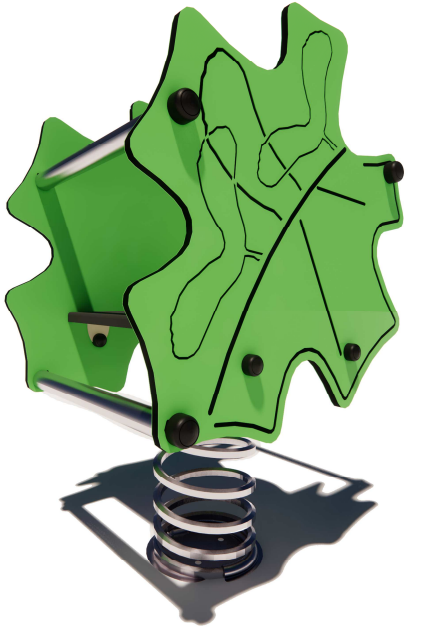

Length: **580 mm**
Width: **425 mm**
Height: **870 mm**

Length of safety area: **3 540 mm**
Width of safety area: **3 425 mm**
Required safety area: **10,21 m²**

(Install shock absorbing material according to EN 1176:2017)



1
children



< 6
age

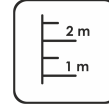

0,40 m
height of fall

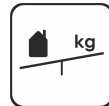

8 kg
(heaviest part)

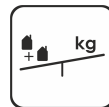

... kg



....
(without excavation and concreting)

Playground equipment steel foundation is concreted in the ground at the planned location. The equipment can be used after two days when the concrete becomes solid. During assembly no children are allowed in the area.

Foundation should be accessible for maintenance.

Equipment safety checkings must be performed once in a week in high vandalism risk area.

Maintainance is required once in every 3 months, depending on usage.

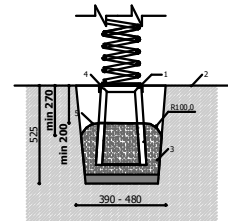

0,420

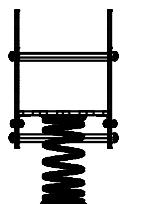
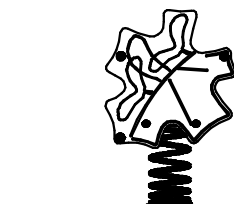

0,870

0,000

Transportation:

1 (one) package:
1 000 x 500 x 500 mm

Spare parts:

All needed spare parts and elements, when warranty time expires can be ordered in Jūrmalas Mežaparki Ltd., and all the goods will be ready for delivery in 5 working days.

According to EN 1176-6:2017

Manufactured according:
07.11.2019.

