

~ Vicenza ~

Contents / Inhalt / Contenu / Inhoud:

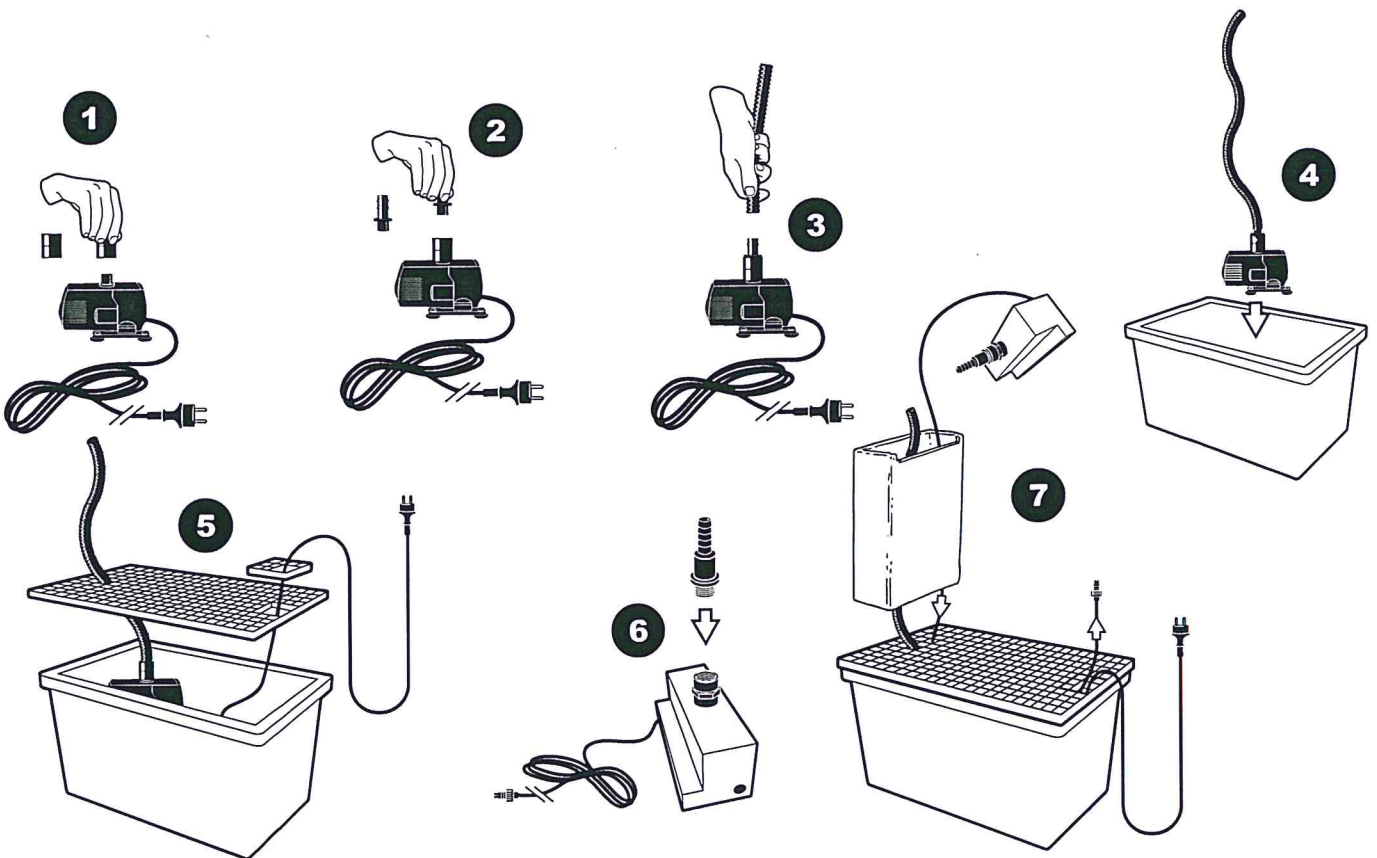
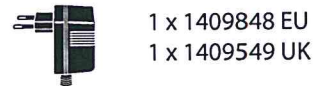
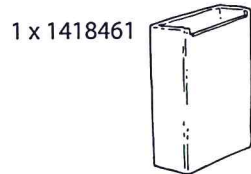
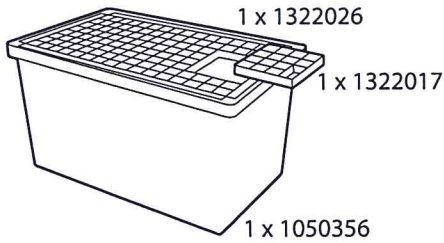
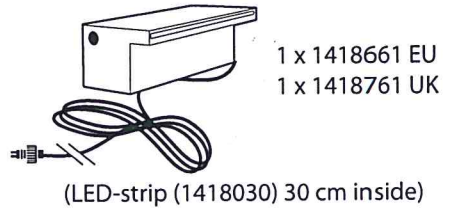
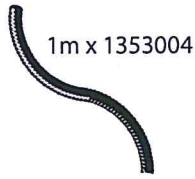
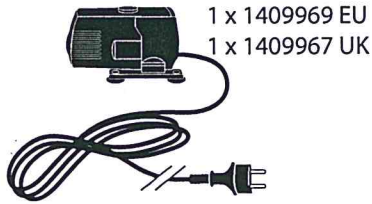

AcquaArte

~ Vicenza ~

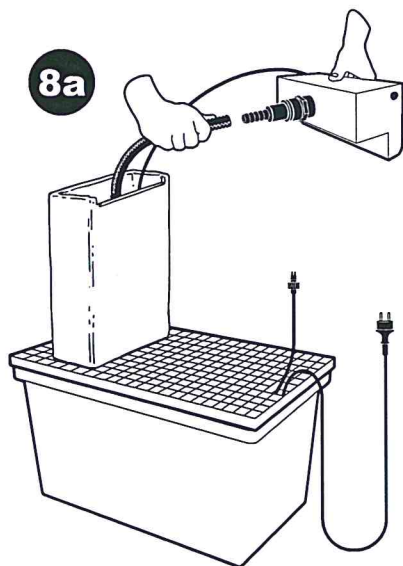

8a

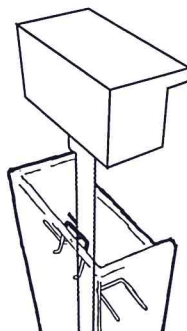

8b

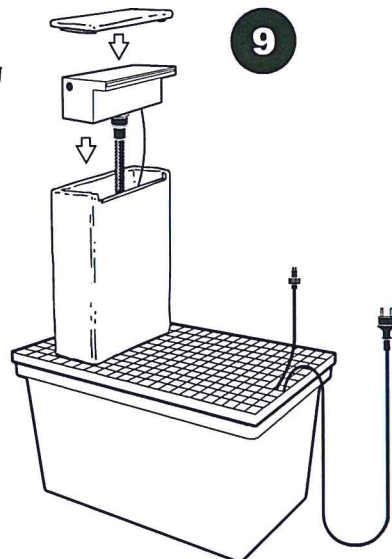

9

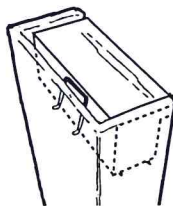

8c

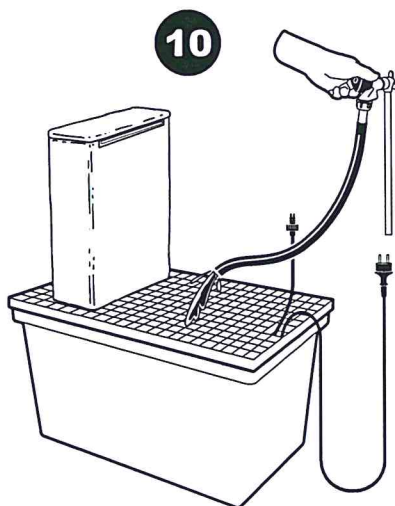

10

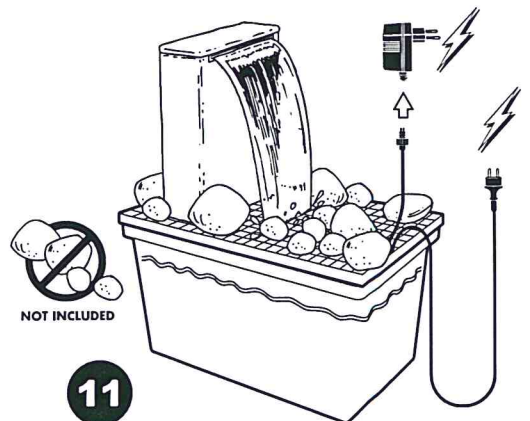

11

- During severe frost switch off the pump, remove ornament and pump!
- Bei strengem Frost sollte das Set ausgeschaltet sowie das Deko-Element und Pumpe entfernt werden!
- Tijdens strenge vorst set uitschakelen, ornament en pomp verwijderen!
- Protégez votre fontaine décorative et mettez votre pompe à l'arrêt pendant la période d'hiver.

- To be sure to hold the colour of the terrazzo, material must be treated every 3 months with linseed oil.
- Dekoelemente aus Terrazzo sollten ca. alle 3 Monate mit Leinöl behandelt werden, um die Farbechtheit zu erhalten.
- Terrazzo Ornament dient iedere 3 maanden behandeld te worden met "lijfolie" om de kleur vastheid te garanderen.
- Conseil d'entretien de la figurine en terrazzo pour un maintien parfait des couleurs : appliquer de l'huile de lin tous les 3 mois.

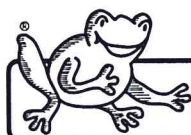

ubbink

www.ubbinkgarden.com