

Abb. 1

Schrauben lösen



Abb. 2

Oberteil abheben

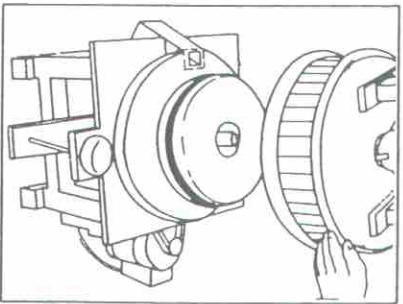

Abb. 3

Festdrehen des Steines  
mittels Handrad  
auf „Fein“

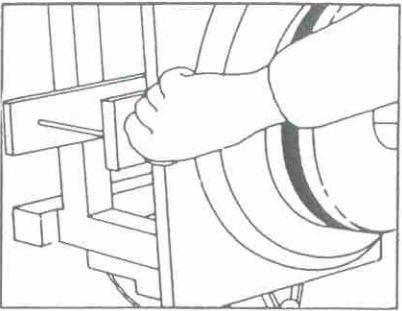

Abb. 4

Exzentrerschraube  
leicht lockern.

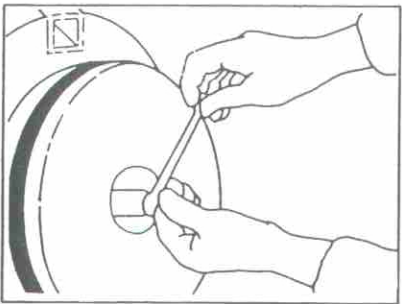

Abb. 5

Leichter Schlag auf  
die Exzentrerschraube

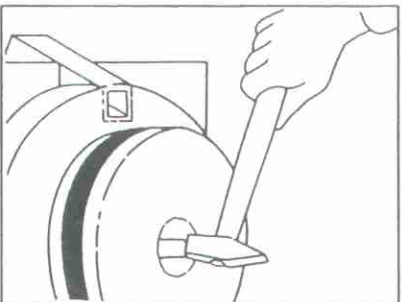

Abb. 6

Herausdrehen der  
Exzentrerschraube

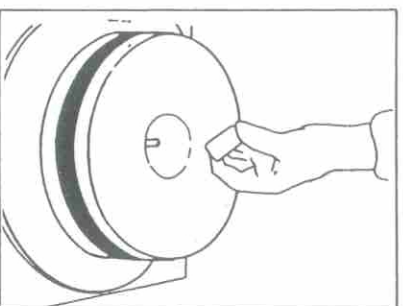

Abb. 7

Abheben des Steines

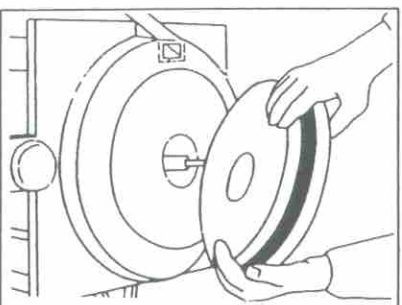
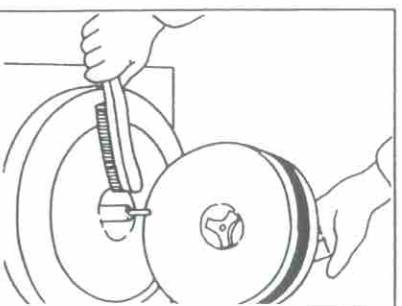

Abb. 8

Reinigen der Steine.  
Mittels Handrad auf „grob“  
drehen, Stein aufsetzen und  
festschrauben.