

INGOMBRI GENERALI lavaggio mod. TEKNOWASH
OVERALL DIMENSIONS backwash mod. TEKNOWASH

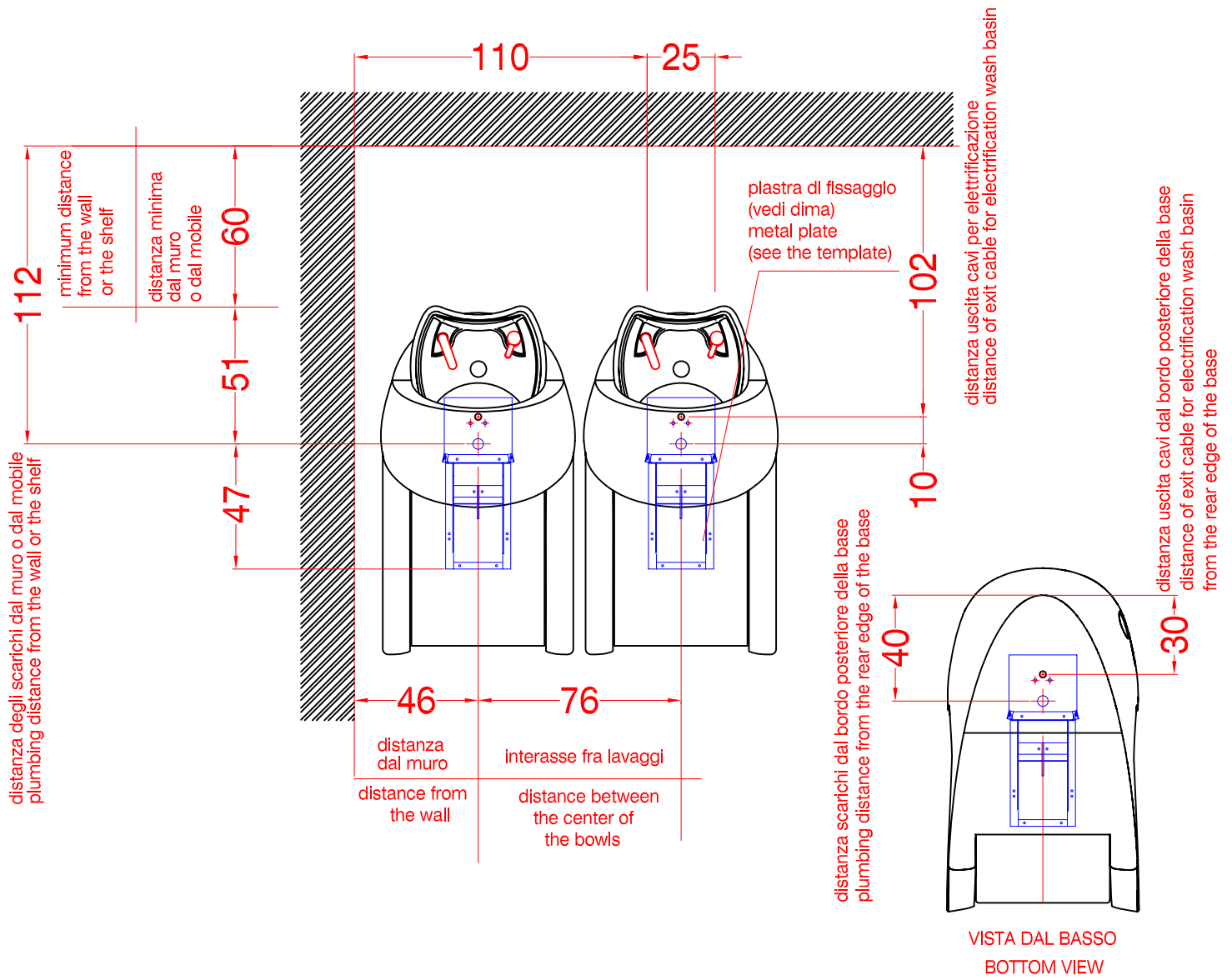

IMPIANTI IDRICI - TEKNOWASH PLUS - SOUND - S - version
 PLUMBING DISTANCE FROM WALLS - TEKNOWASH PLUS - SOUND - S - version

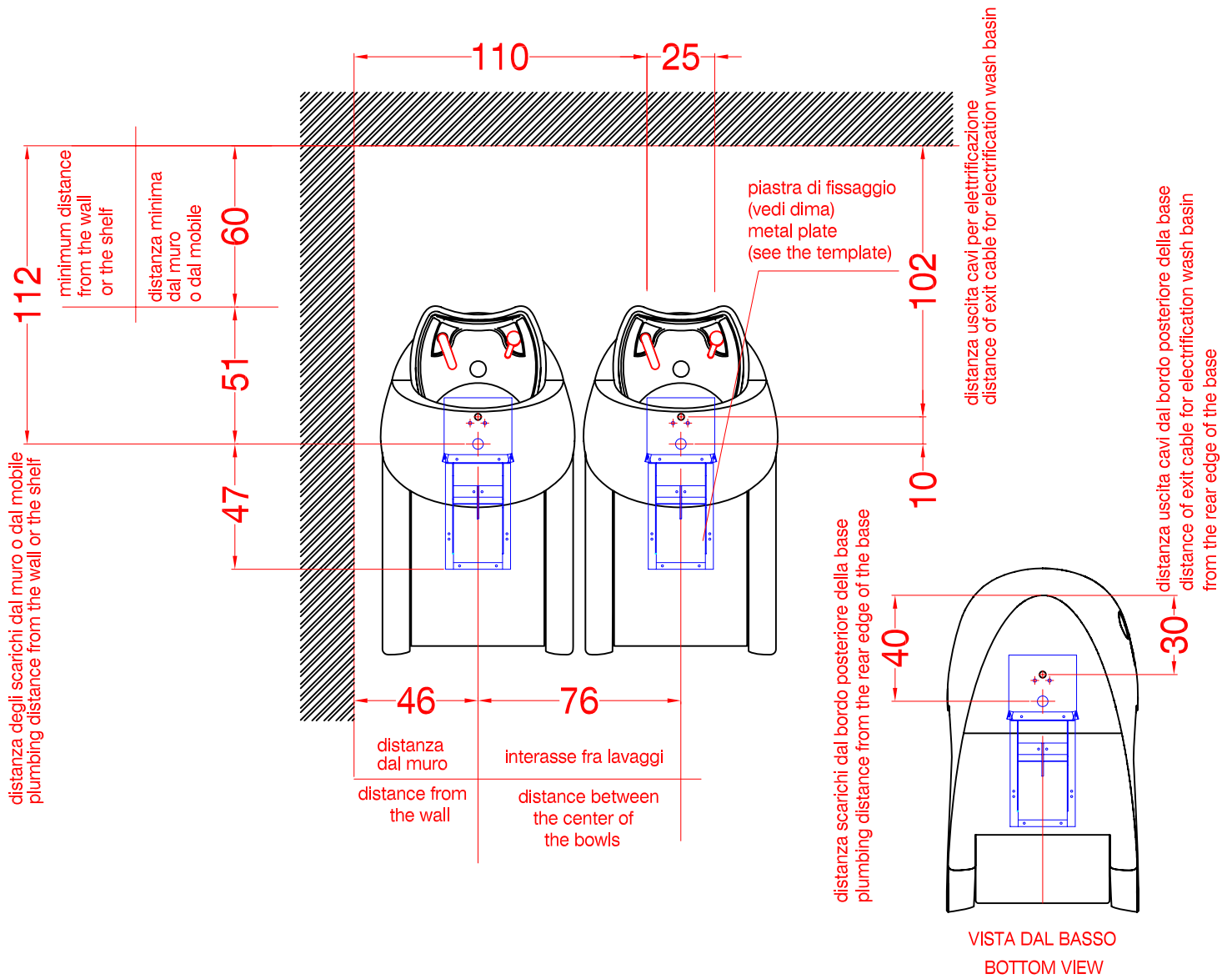

IMPIANTI IDRICI - TEKNOWASH BASIC version
PLUMBING DISTANCE FROM WALLS - TEKNOWASH BASIC version

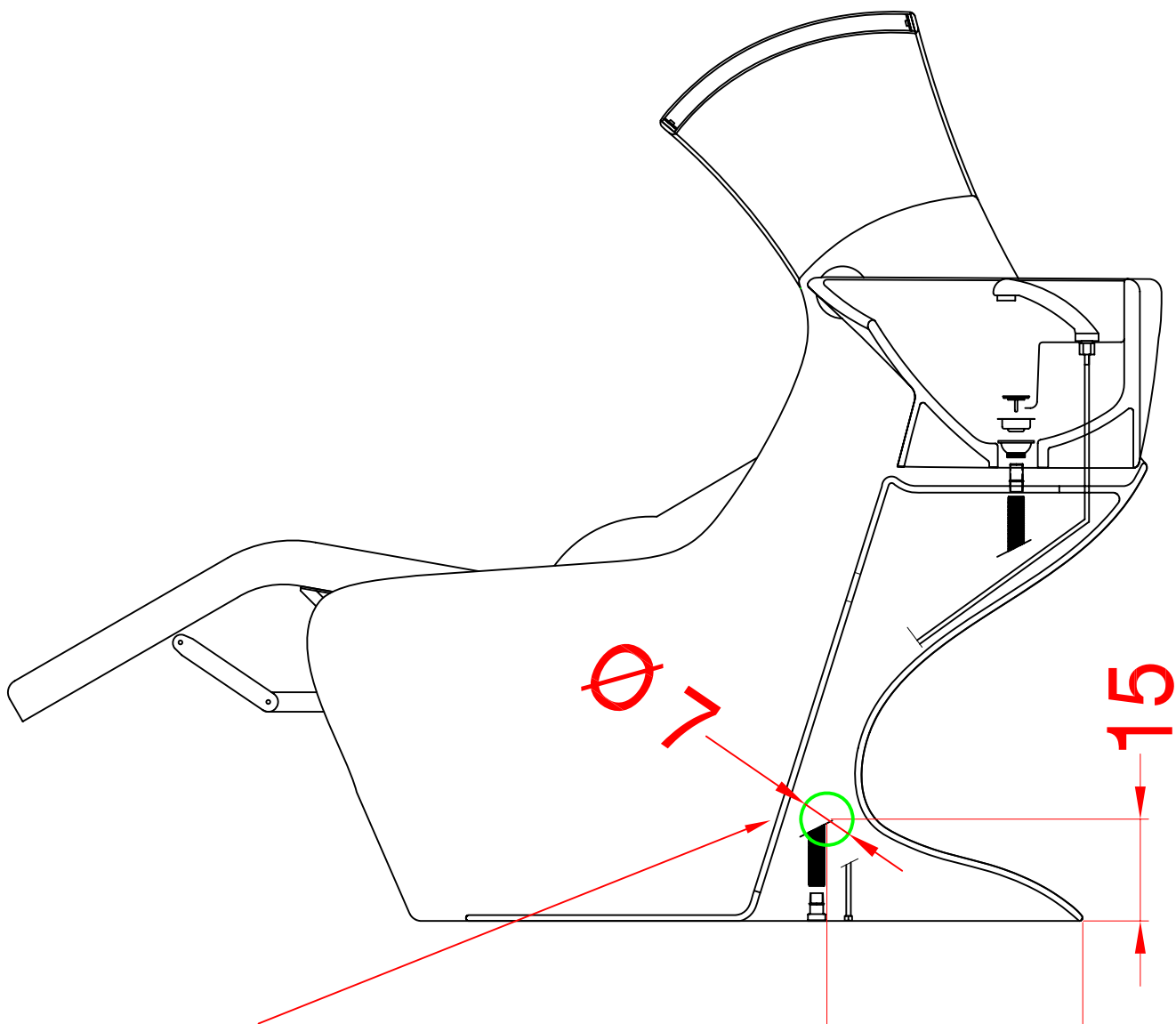

foro da praticare con fresa a tazza
 per imbocco tubo scarico a parete
 Attenzione! le misure indicate sono
 approssimate. E' importante praticare
 il foro nella zona posteriore del lavaggio
 evitando di oltrepassare la parete divisoria interna

40 ≈

15

to drill with hole - saw. Pls. Note: rough dimensions.

Take care to drill only the outer shell, not to pierce the inner partition



foro per scarico a parete - TEKNOWASH PLUS - SOUND - S - version
 hole for wall plumbing - TEKNOWASH PLUS - SOUND - S - version

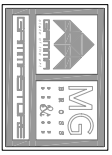

DIMA TECNOWASH BASIC

TEMPLATE TECNOWASH BASIC (floor fixing position - drainage & water feed position)

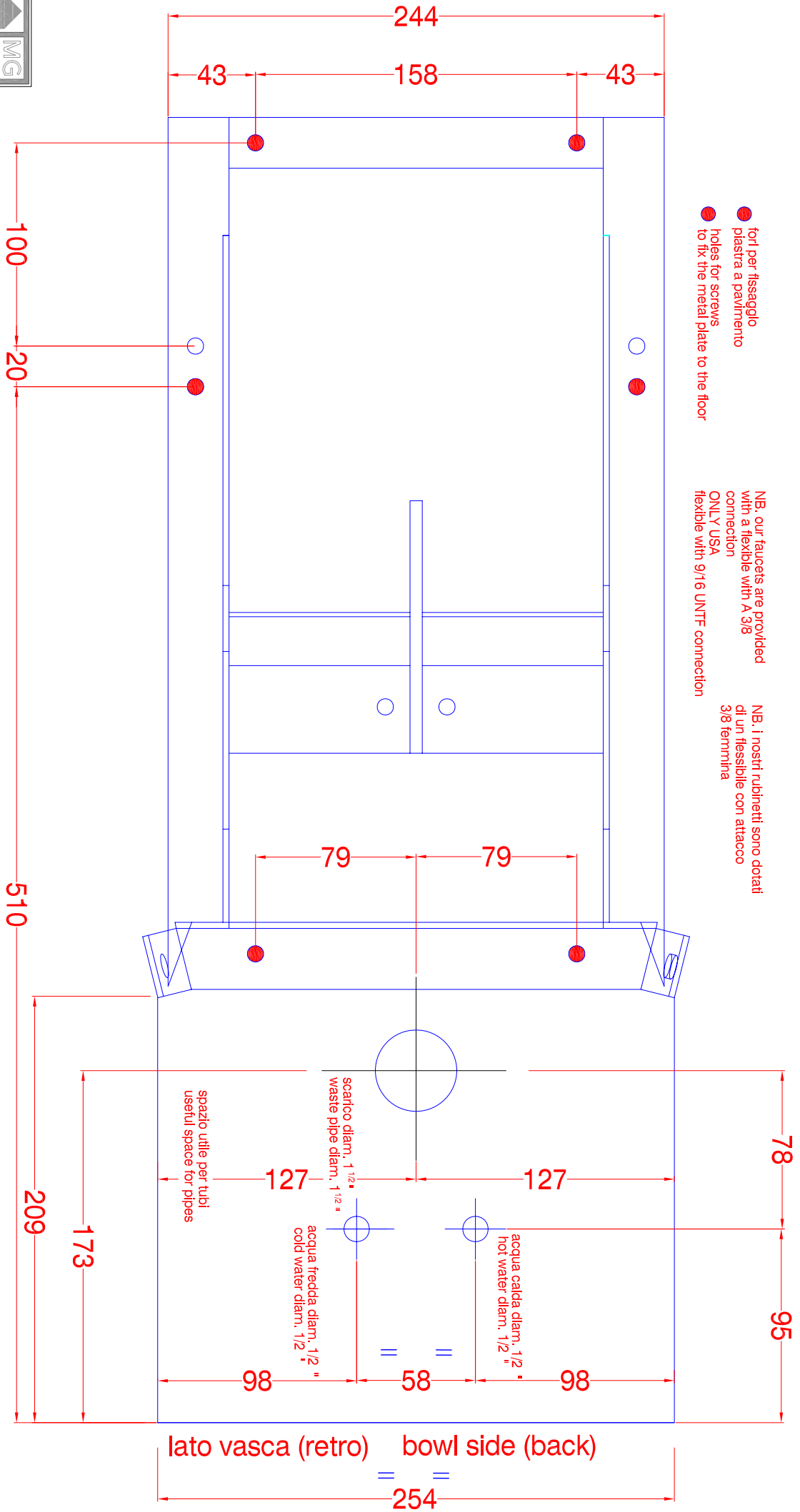

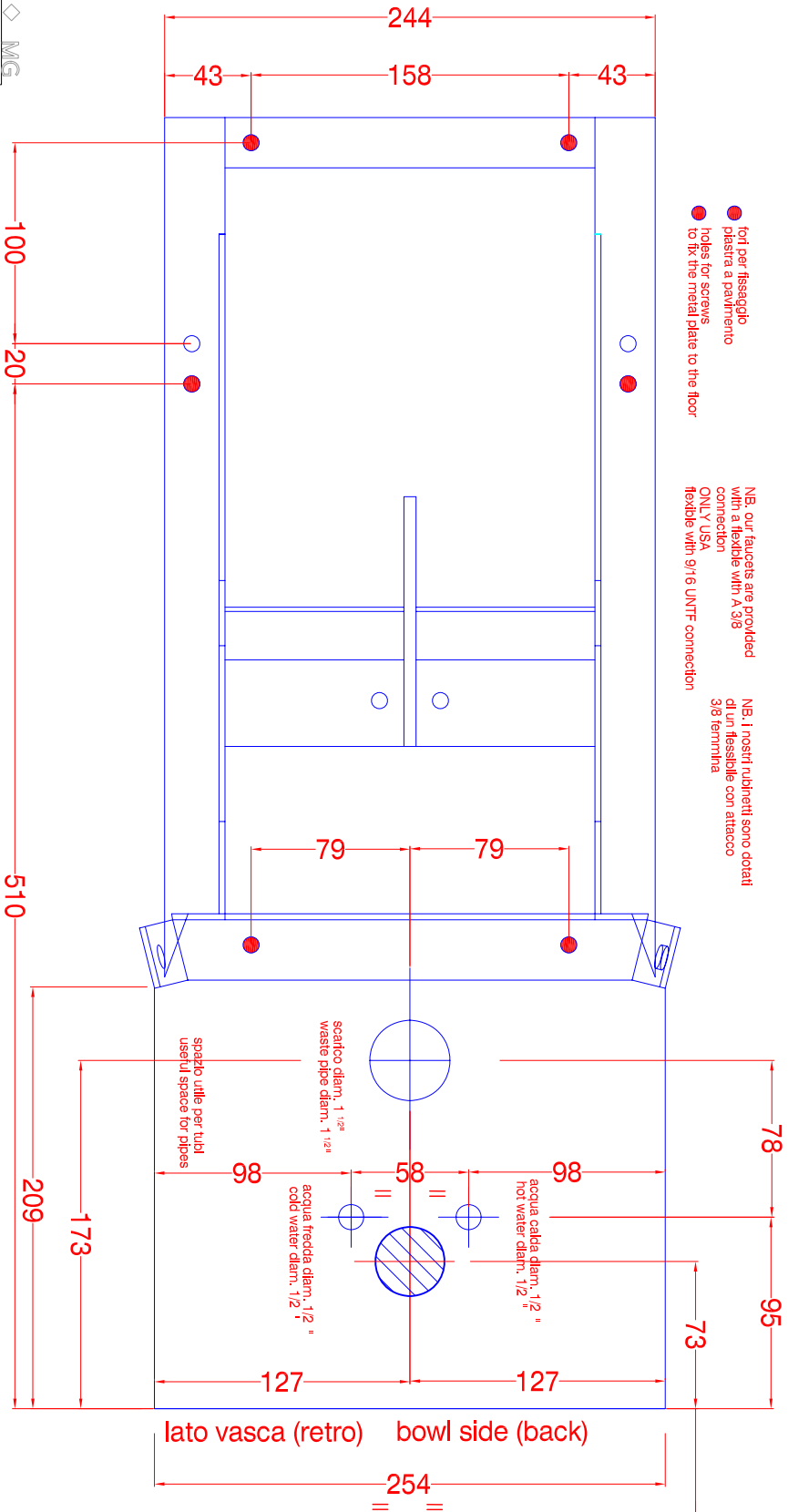
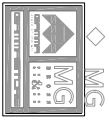

● for per fissaggio
 piastra a pavimento
 ● holes for screws
 to fix the metal plate to the floor

NB, our faucets are provided
 with a flexible with A 3/8
 ONLY USA
 flexible with 9/16 UNTF connection

NB, i nostri rubinetti sono dotati
 di un flessibile con attacco
 3/8 femmina

78 95

73

lato vasca (retro) bowl side (back)

254



Usata cavo per elettrificazione lavaggio:

VIBRO (V.220 - W.150):

- Cavo cm 100 con presa SCHUKO (10 A.)

ARI (MASSAGE) (V.220 - W.150)

- Cavo cm 100 con presa SCHUKO (10 A.)

wash basin electric outlet:

VIBRO (V.220 - W.150):

- exit cable (100 cm) electrification provided SCHUKO plug (10A.)

ARI (MASSAGE (V.220 - W.150)

- exit cable (100 cm) electrification provided SCHUKO plug (10A.)

ONLY USA

- exit cable V. 110

DIMA TECNOWASH BASIC

TEMPLATE TECNOWASH PLUS -SOUND -S (floor fixing position - drainage & water feed position)

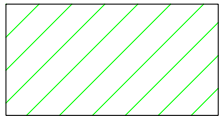

Attenzione! Evitare connessioni elettriche nella zona tratteggiata. Possibile presenza di acqua o umidità

Warning! Avoid any electrical connection or clamping in the hatched area. Wet or moist area

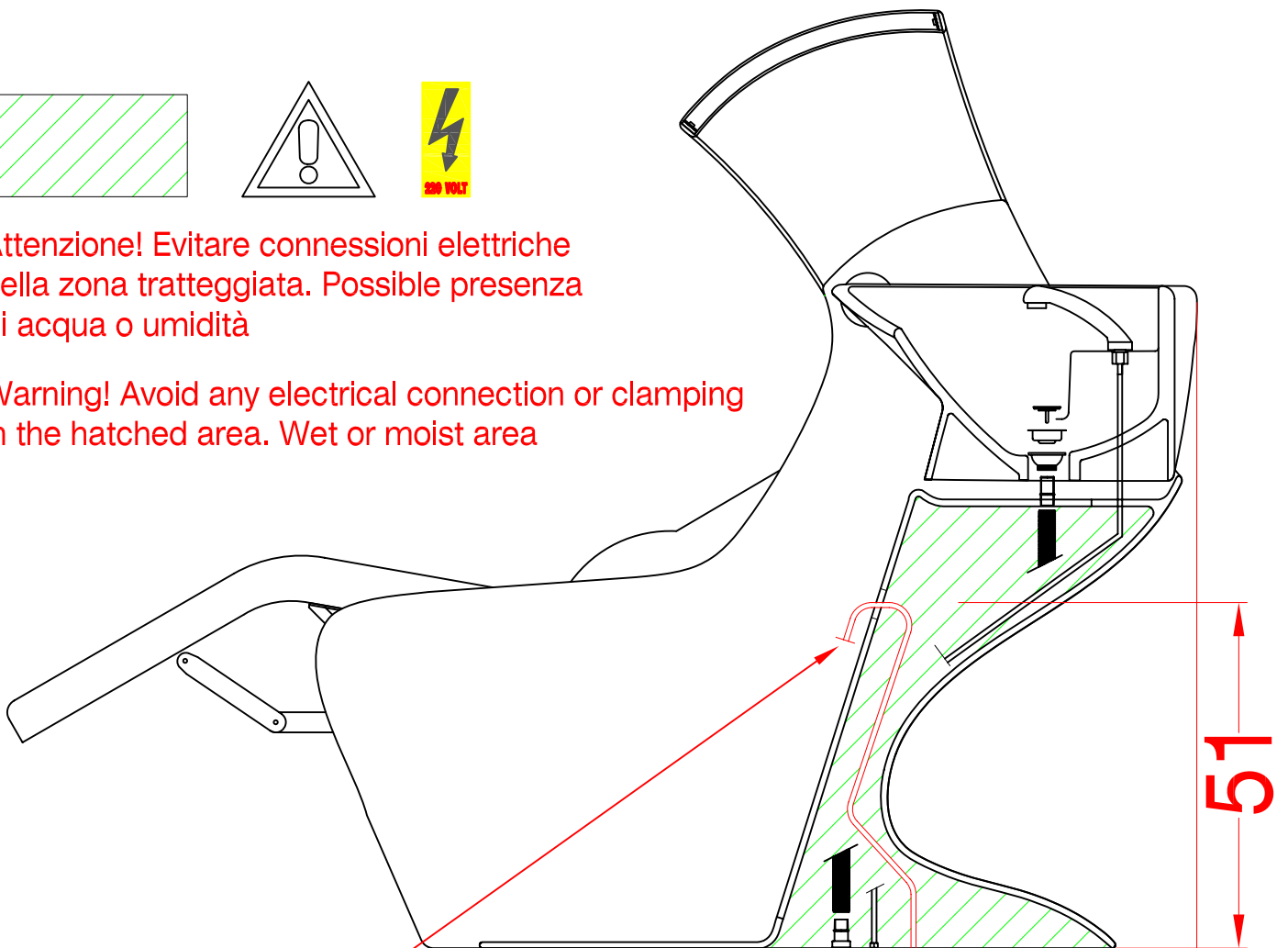

Elettrificazione lavaggio:

VIBRO (V.220 - W.150):

- Cavo cm 100 con presa SCHUKO (10 A.)

AIR MASSAGGIO (V.220 -W.150)

- Cavo cm 100 con presa SCHUKO (10 A.)

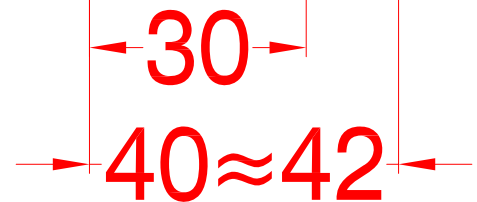

wash basin electrification

VIBRO (V.220 - W.150):

- exit cable (100 cm) electrification provided SCHUKO plug (10A.)

AIR MASSAGE (V.220 - W.150)

- exit cable (100 cm) electrification provided SCHUKO plug (10A.)

ONLY USA

- exit cable V. 110



IMPIANTO ELETTRICO - TEKNOWASH PLUS - SOUND - S - version
ELECTRIC SCHEME - TEKNOWASH PLUS - SOUND - S - version

DATI TECNICI - IMPIANTO HI FI AUDIO
TECHNICAL DATA - HI FI AUDIO SYSTEM

Alimentazione in ingresso: 85 ~ 264 VAC
 Input voltage: 85 ~ 264 VAC
 Assorbimento in ingresso: 350 mA per 220 VAC e 700 mA per 110 VAC
 Input current: 350 mA of 220 VAC - 700 mA of 110 VAC
 Frequenza in ingresso: 47 ~ 63 Hz
 Input frequency: 47 ~ 63 Hz
 Tensione in uscita: 12 VCC
 Output voltage: 12 VCC
 Potenza in uscita: 25W
 Output power: 25W
 Alimentazione amplificatore: 9 ~ 13 Vcc
 Amplifier voltage: 9 ~ 13Vcc
 Assorbimento tipico: 2 A a 12Vcc
 Inrush current: 2A measured at 12Vcc
 Potenza audio in uscita: 15 W RMS con carico di 4 Ohm 10 W RMS con carico di 8 Ohm
 Output audio power: 15 W RMS with 4 Ohm load - 10 W RMS with 8 Ohm load
 Dinamica: 102 dB
 Dynamic: 102 dB

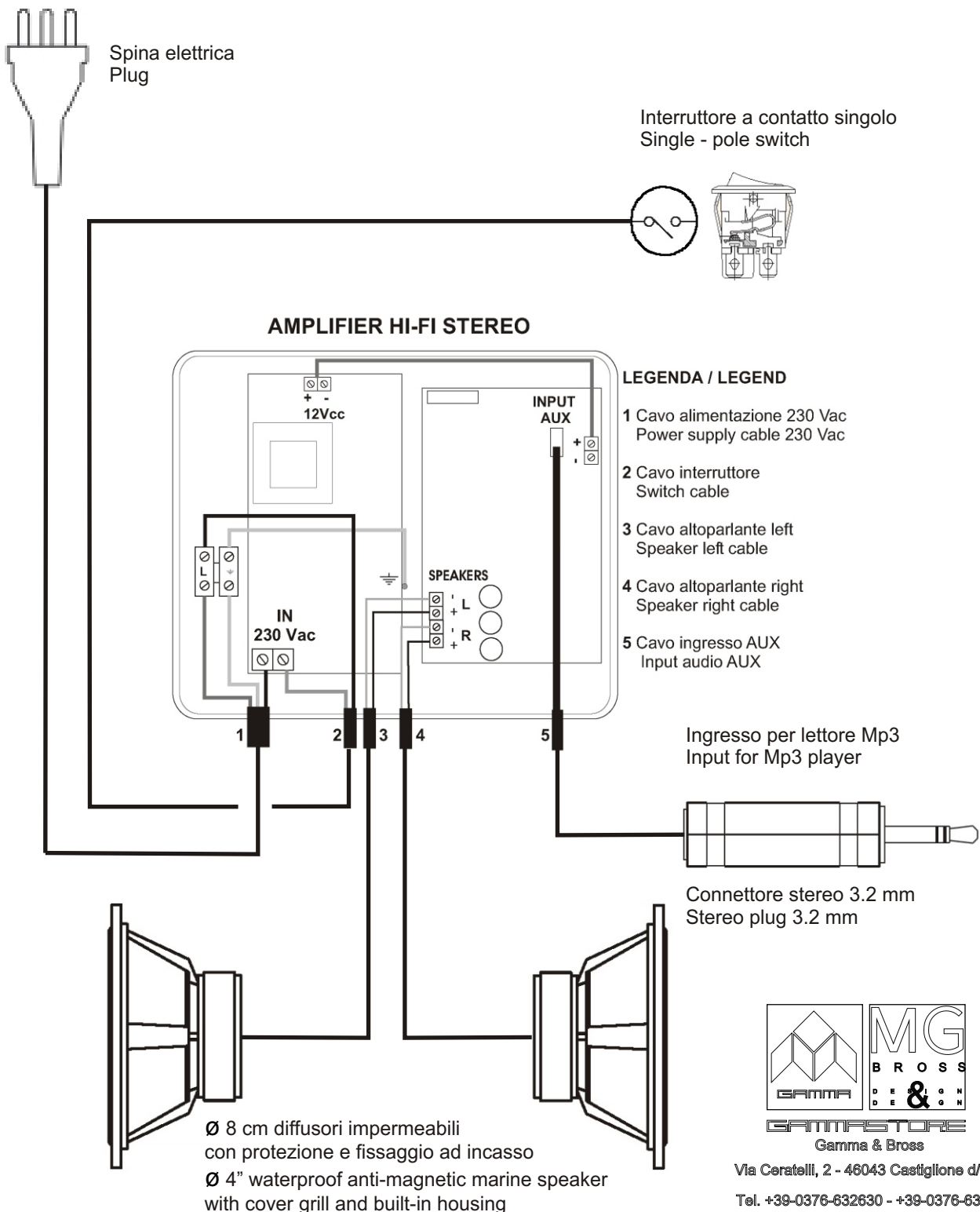

SCHEMA TECNICO

(A) ALIMENTATORE-AMPLIFICATORE
 alimentazione in ingresso: 85 - 264Vac
 frequenza in ingresso: 47 - 63Hz
 assorbimento massimo: 80W MAX
 potenza audio in uscita: 10W RMS
 dinamica: 102 dB

(B) DIFFUSORI
 Ø 8 cm
 impermeabili con protezione e
 fissaggio ad incasso
 impedenza: 8 Ohm

(C) INTERRUTTORE A CONTATTO SINGOLO

(D) CONNETTORE STEREO 3.2 mm

(E) lettore Mp3 I- POD SHUFFLE

(F) SCATOLA DI DERIVAZIONE

TECHNICAL SCHEME

(A) AMPLIFIER - POWER SUPPLY
 input voltage: 85 - 264Vac
 input frequency: 47 - 63Hz
 output power: 80W MAX
 output audio power: 10W RMS
 dynamic: 102 dB

(B) SPEAKERS
 Ø 4"
 waterproof anti-magnetic marine speakers
 with cover-grill & built-in housing
 impedance: 8 Ohm

(C) SINGLE POLE SWITCH

(D) STEREO PLUG 3.2 mm

(E) Mp3 player I- POD SHUFFLE

(F) SHUNT BOX

