

# BAT PNG GTCB AL

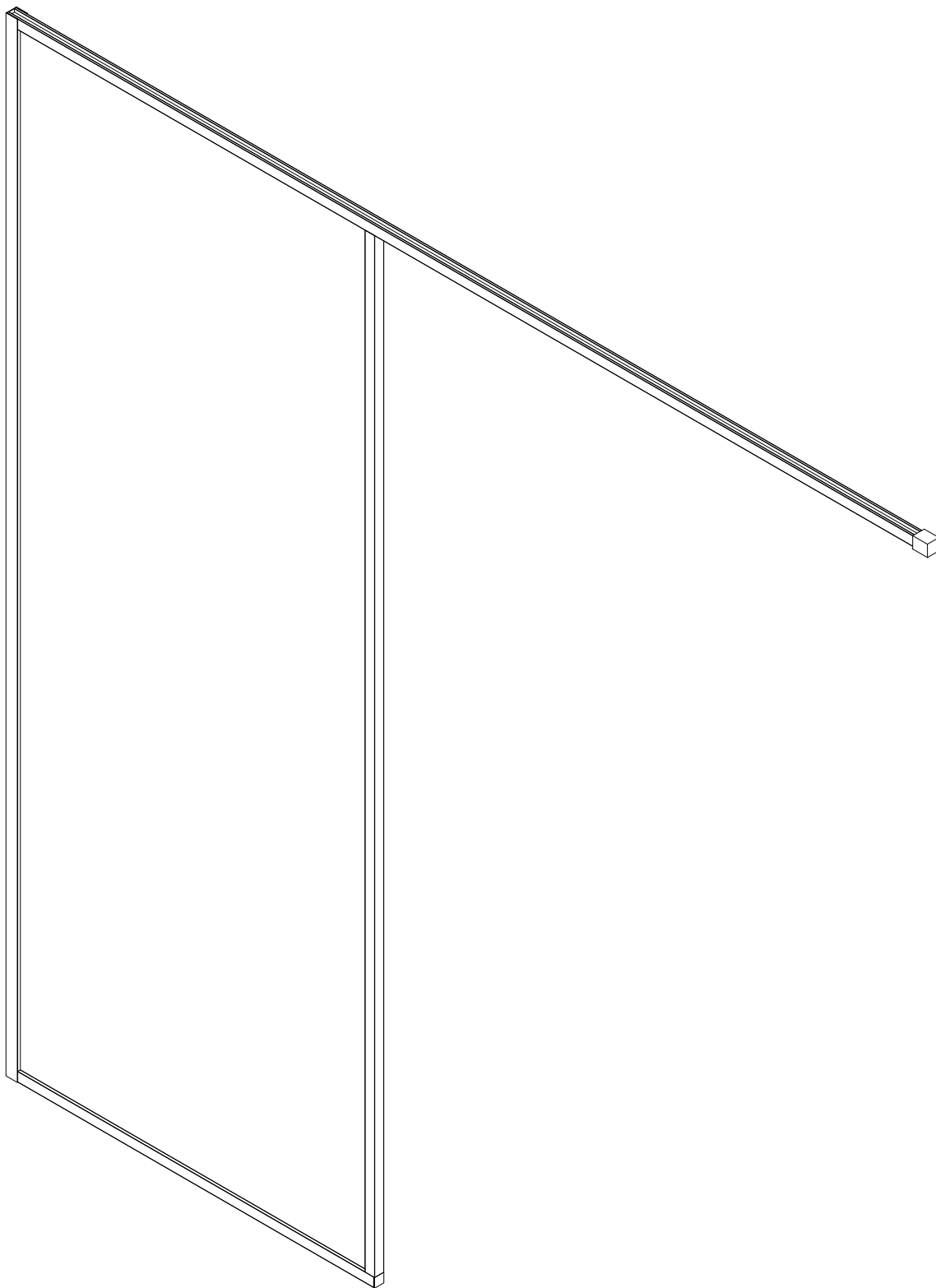

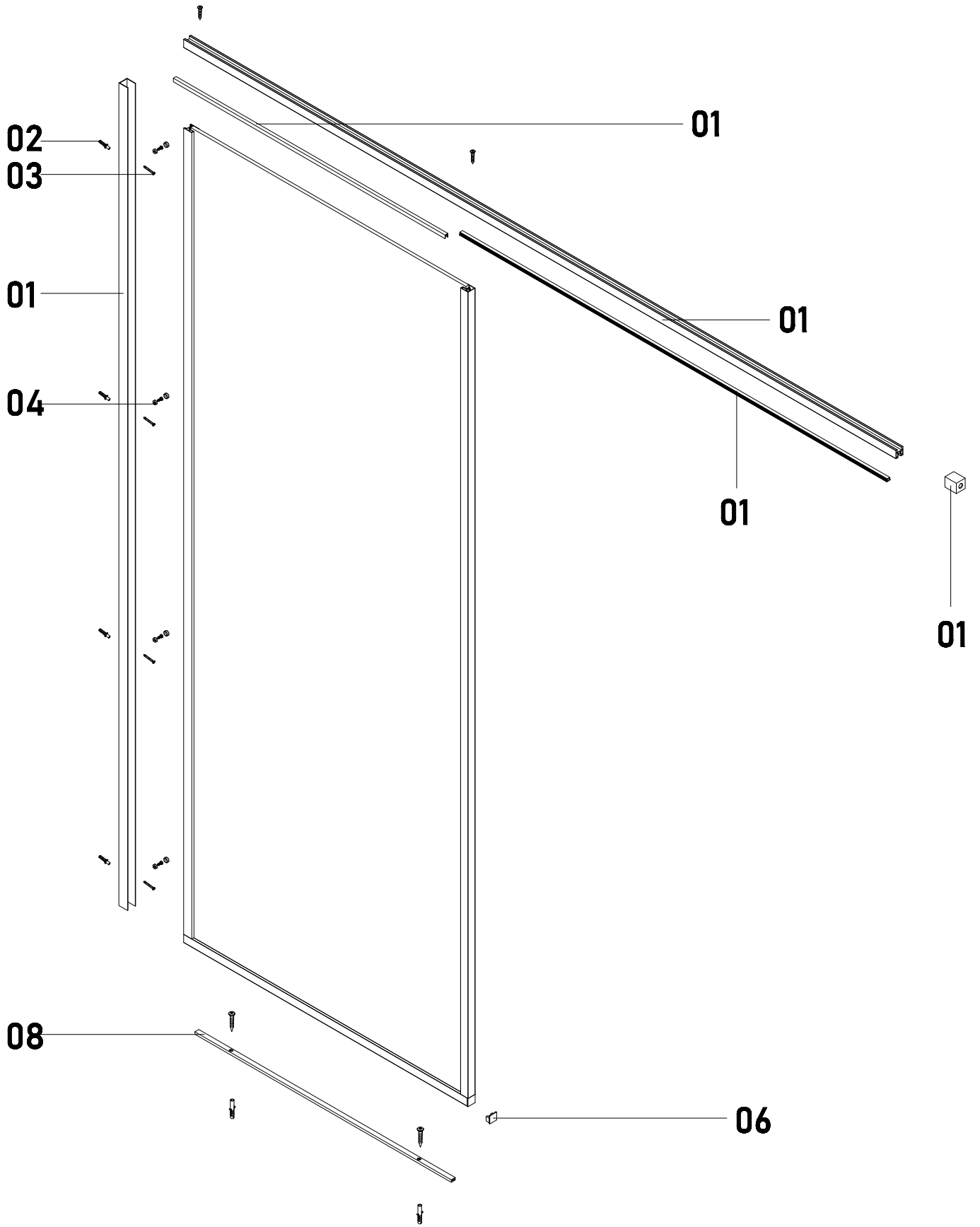

## INSTALLATION ACCESSORIES LIST

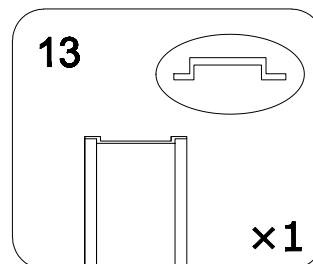
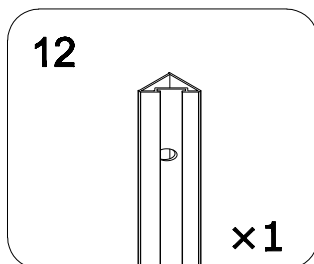
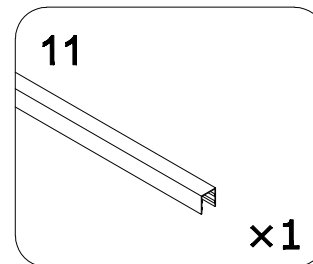
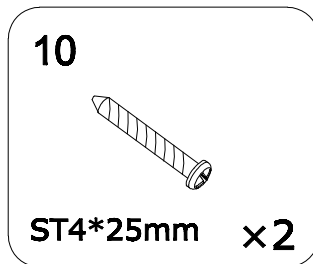
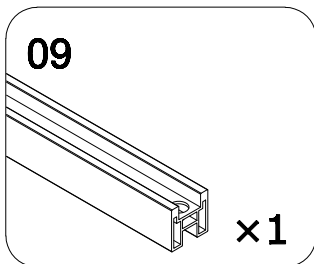
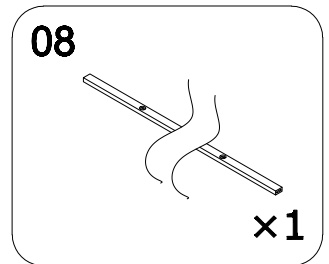
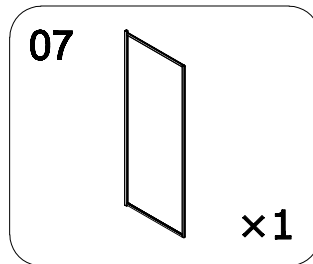
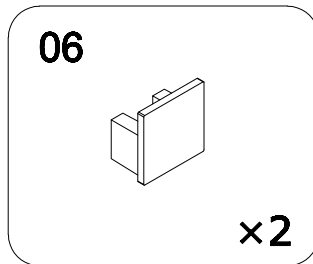
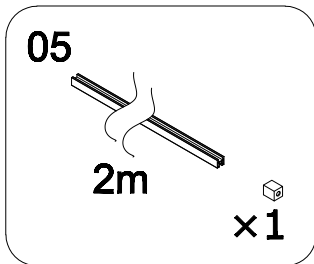
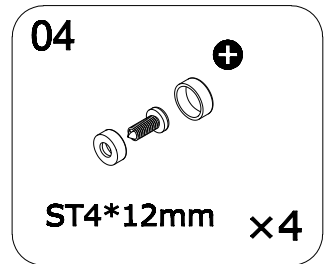
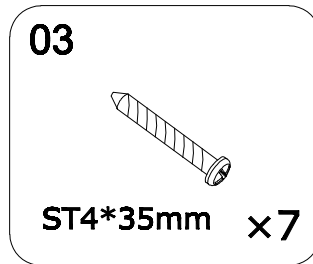
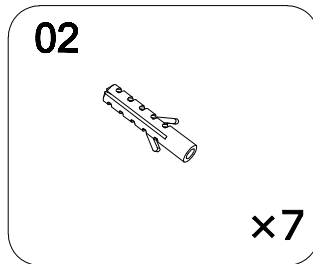
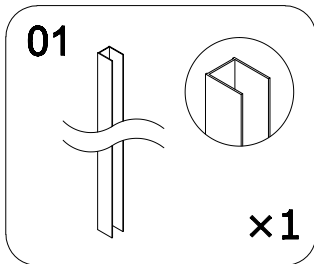

If you buy a fixed wall separately  
please ignore part 12 13  
NO 5 Need to buy separately  
BAT 020 GNG CBCB AL

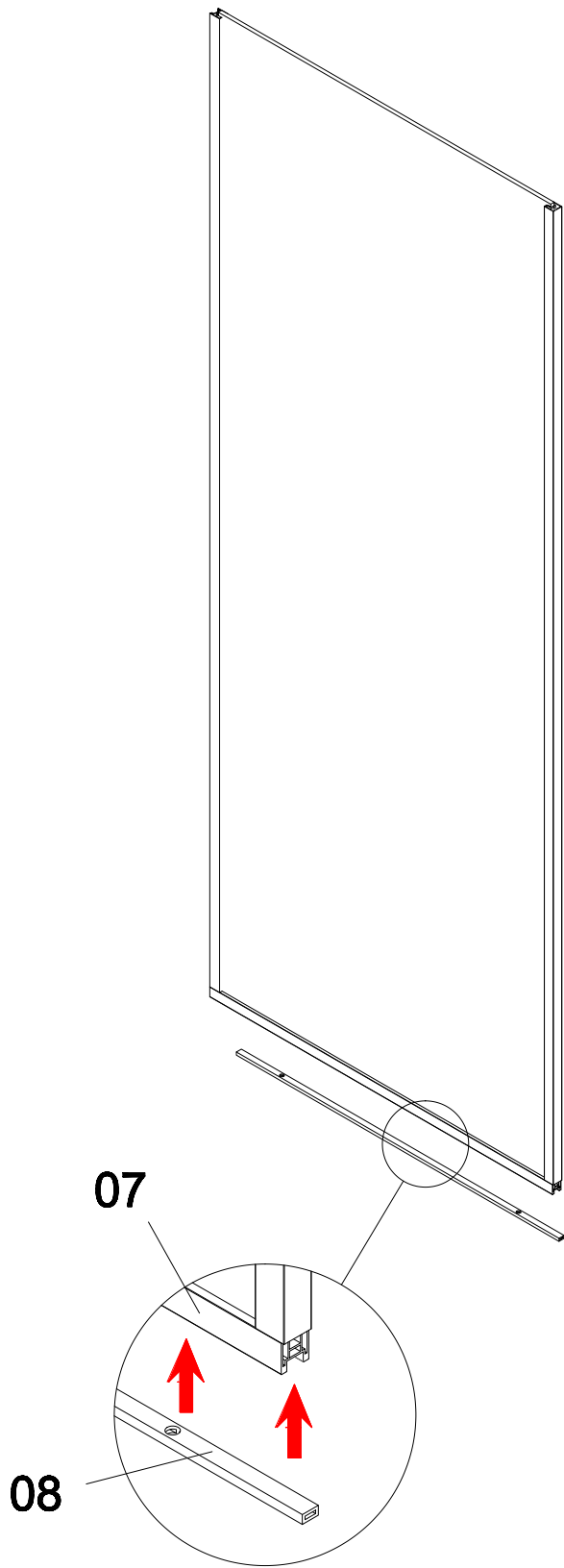

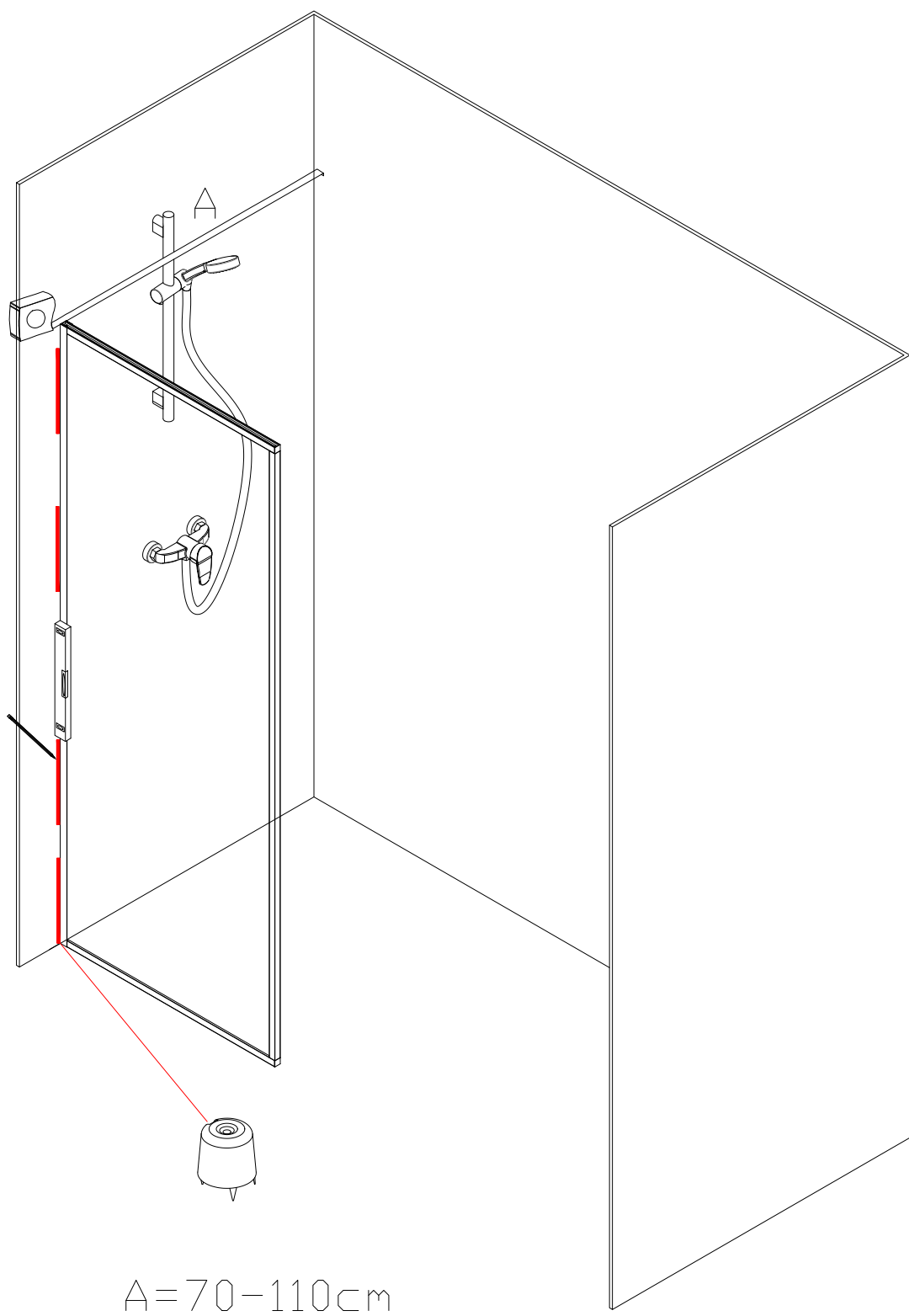

A=70-110cm

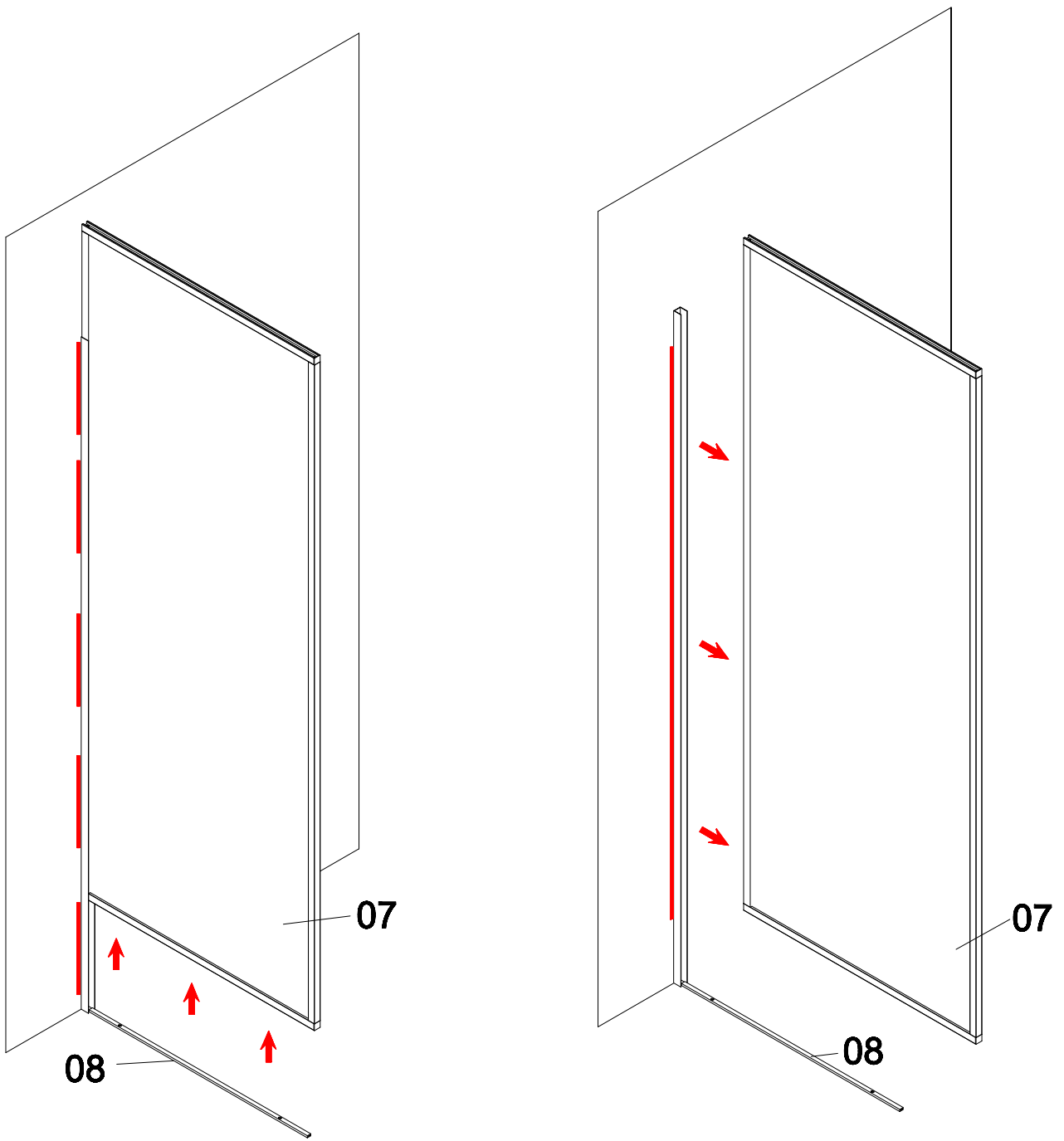

Gently move it up. Don't let "08" change position

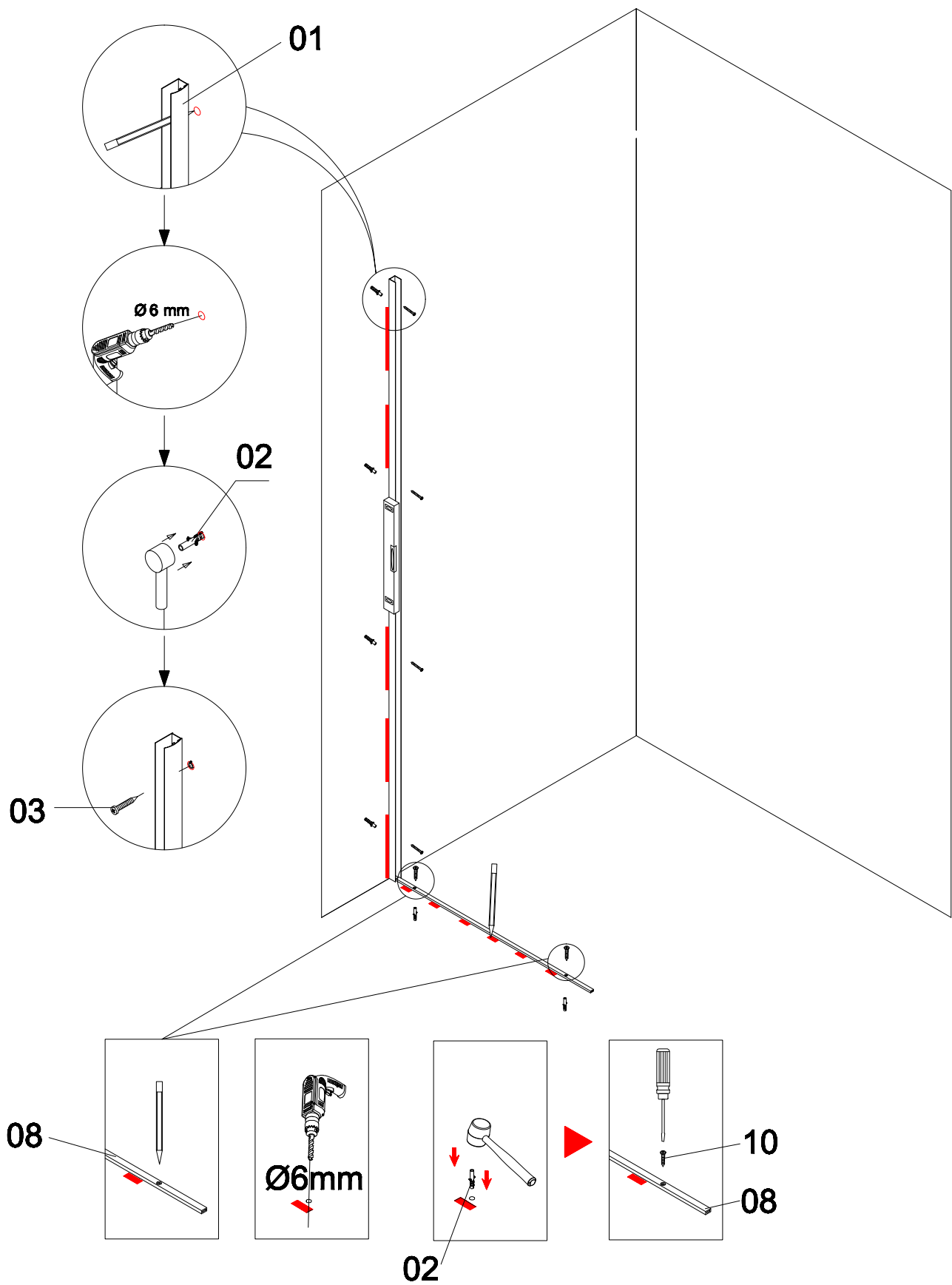

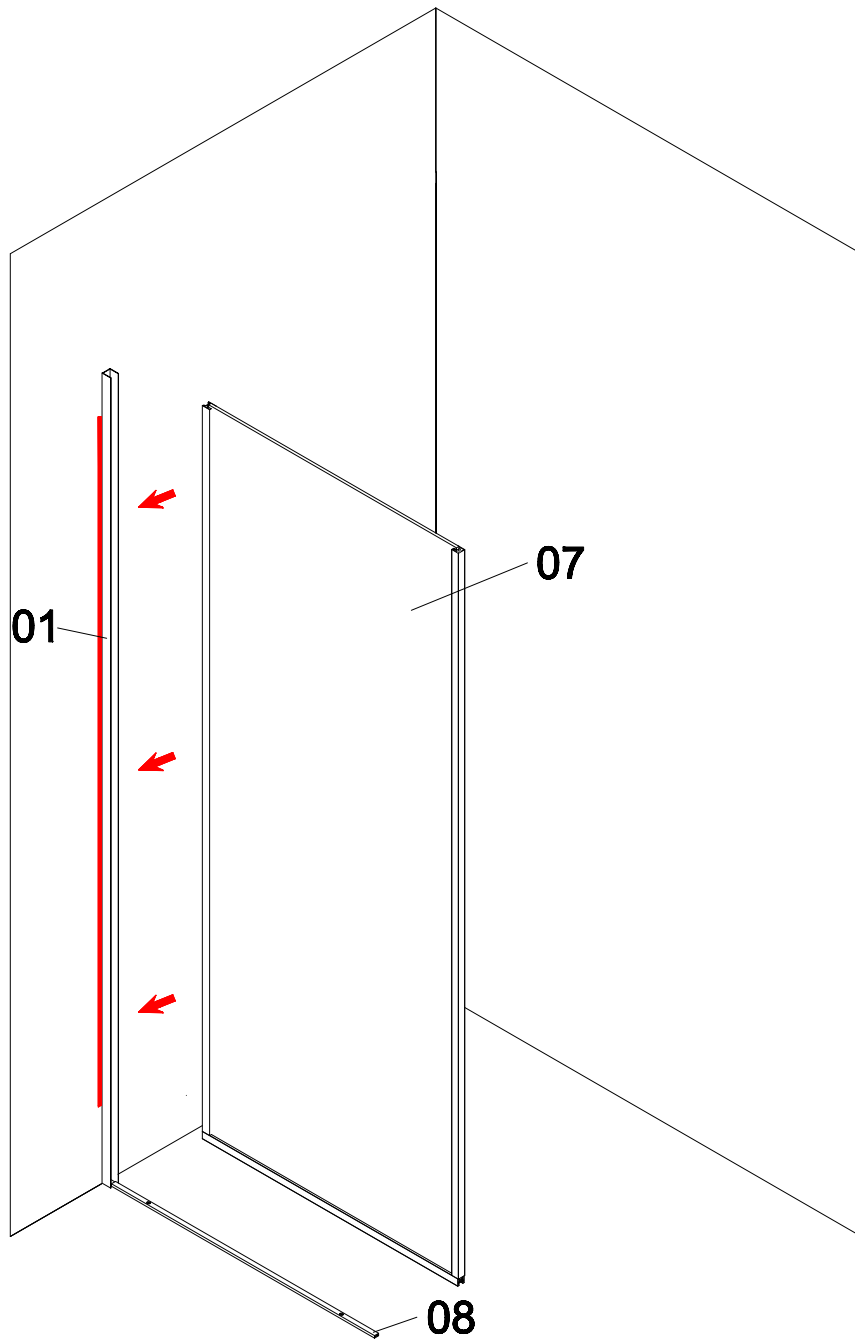



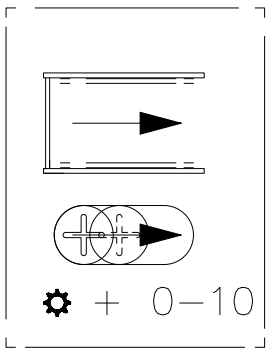
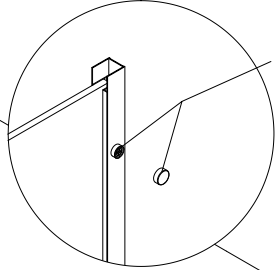
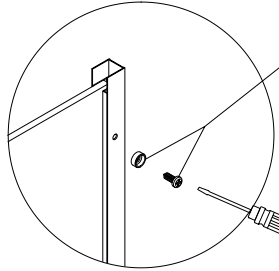
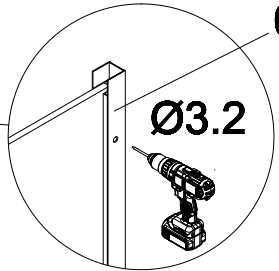
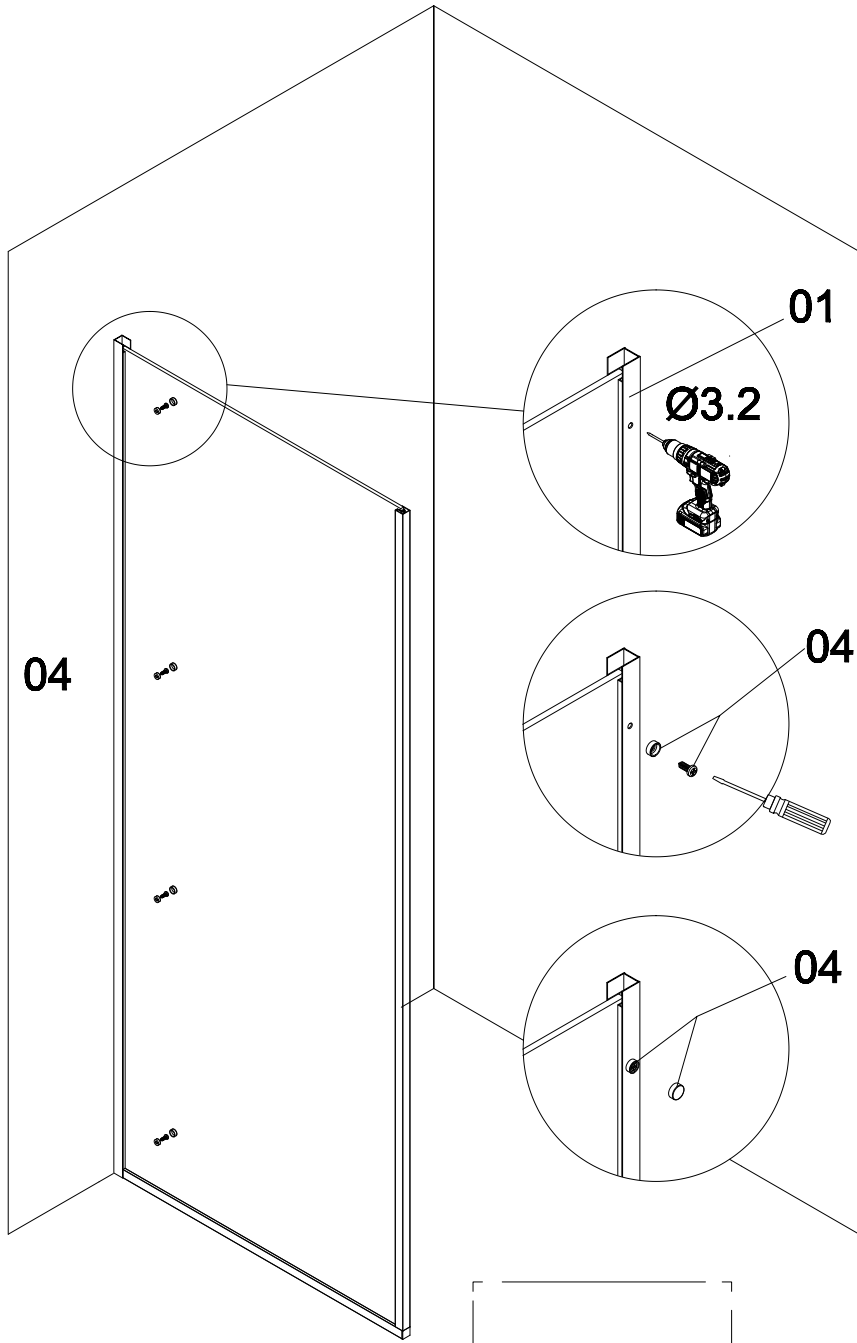

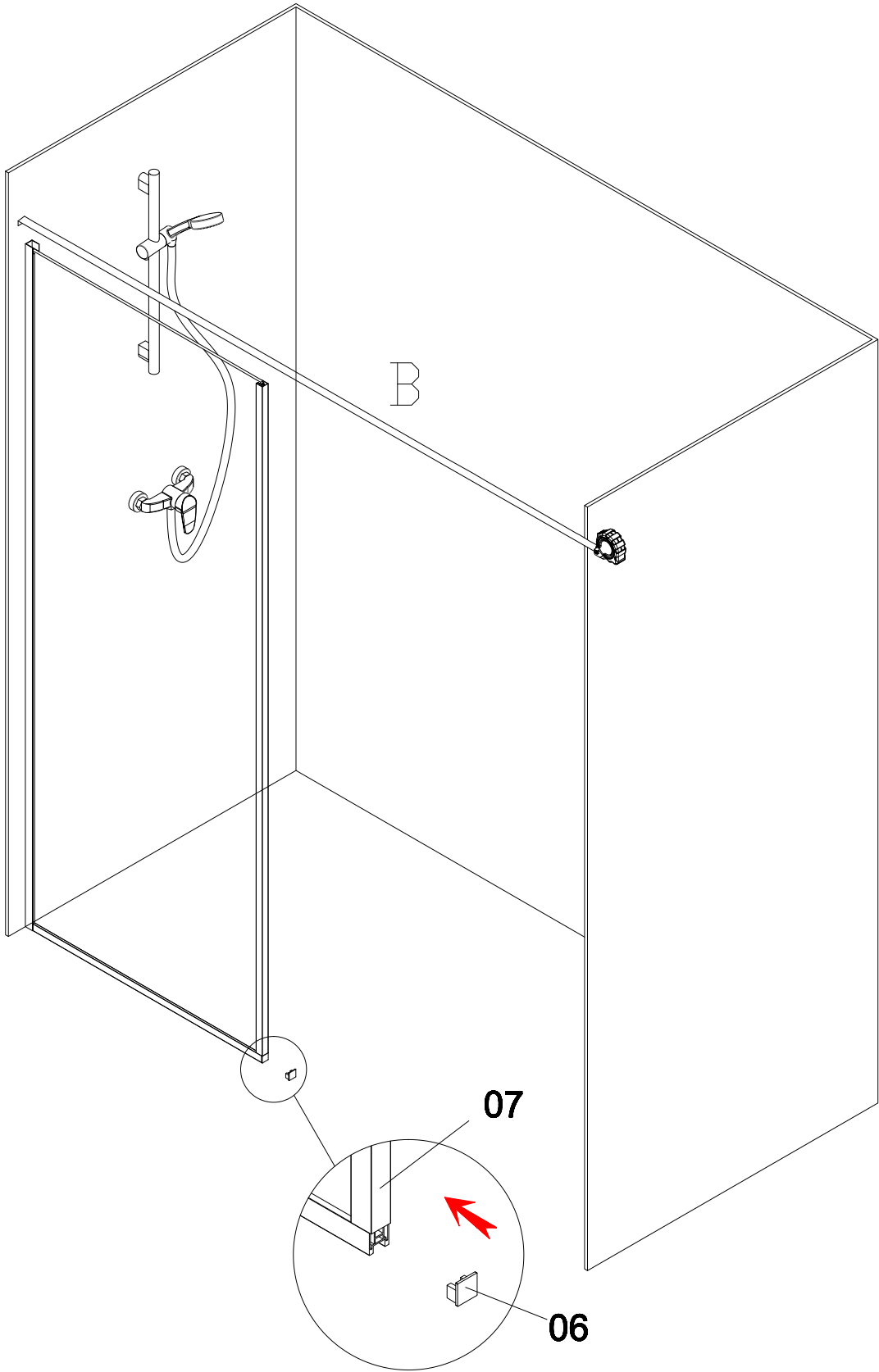

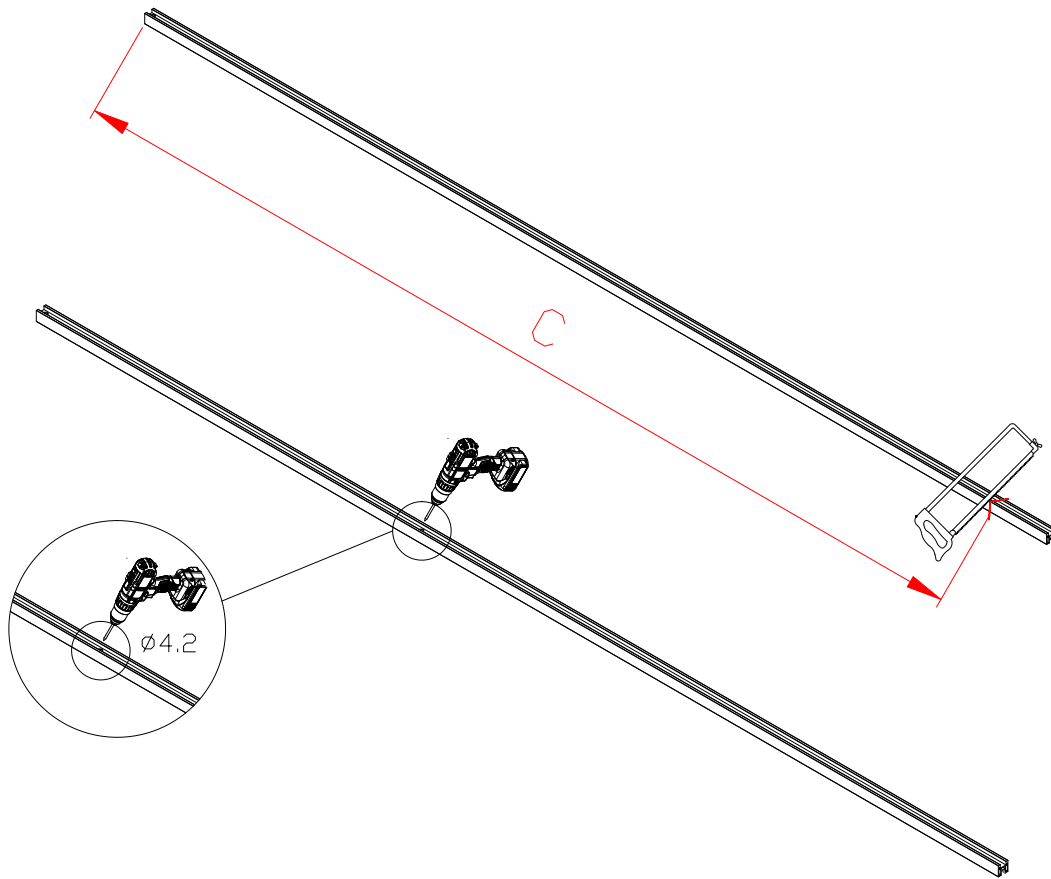

$$C = B - 30\text{mm}$$

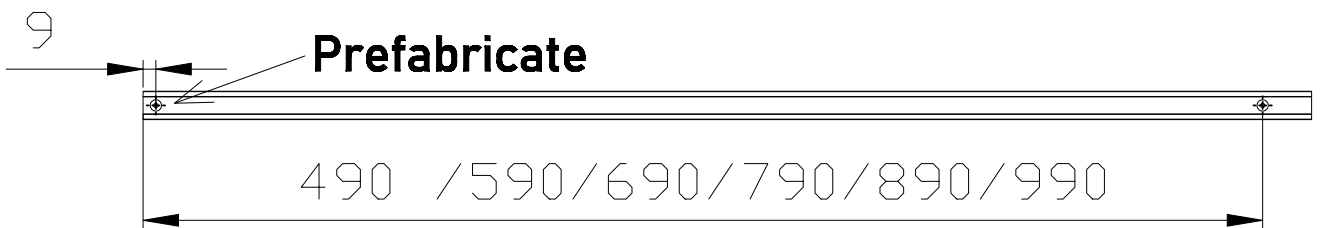

**Prefabricate**

490 / 590 / 690 / 790 / 890 / 990

