

BAT PNG GTCB AL

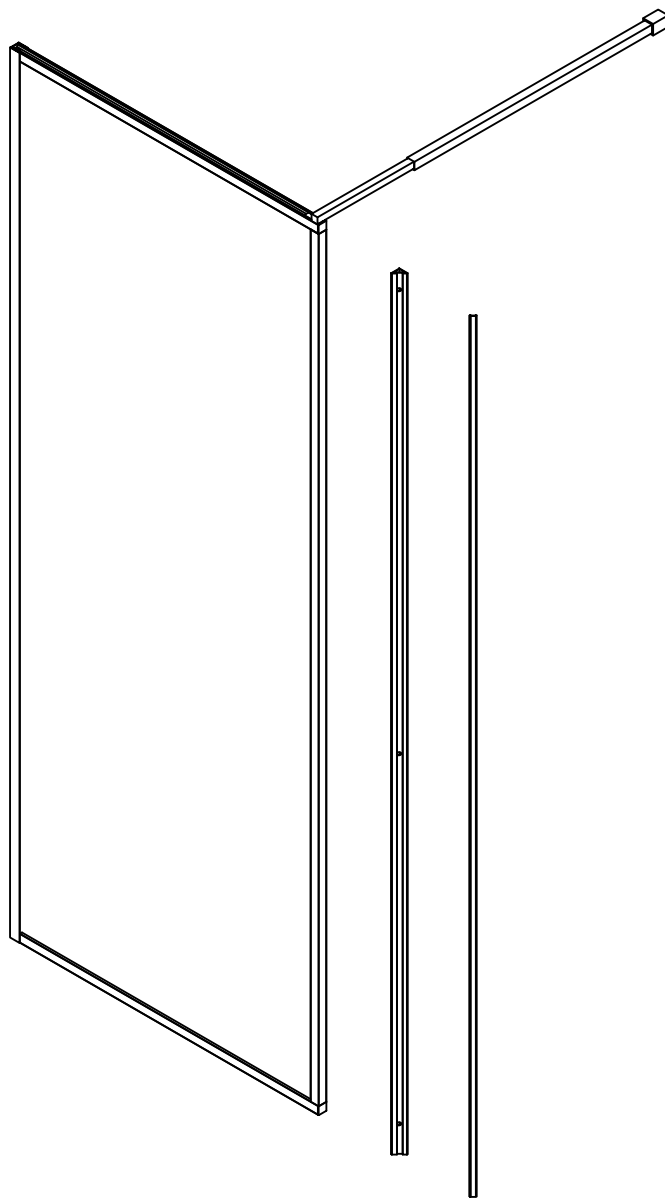

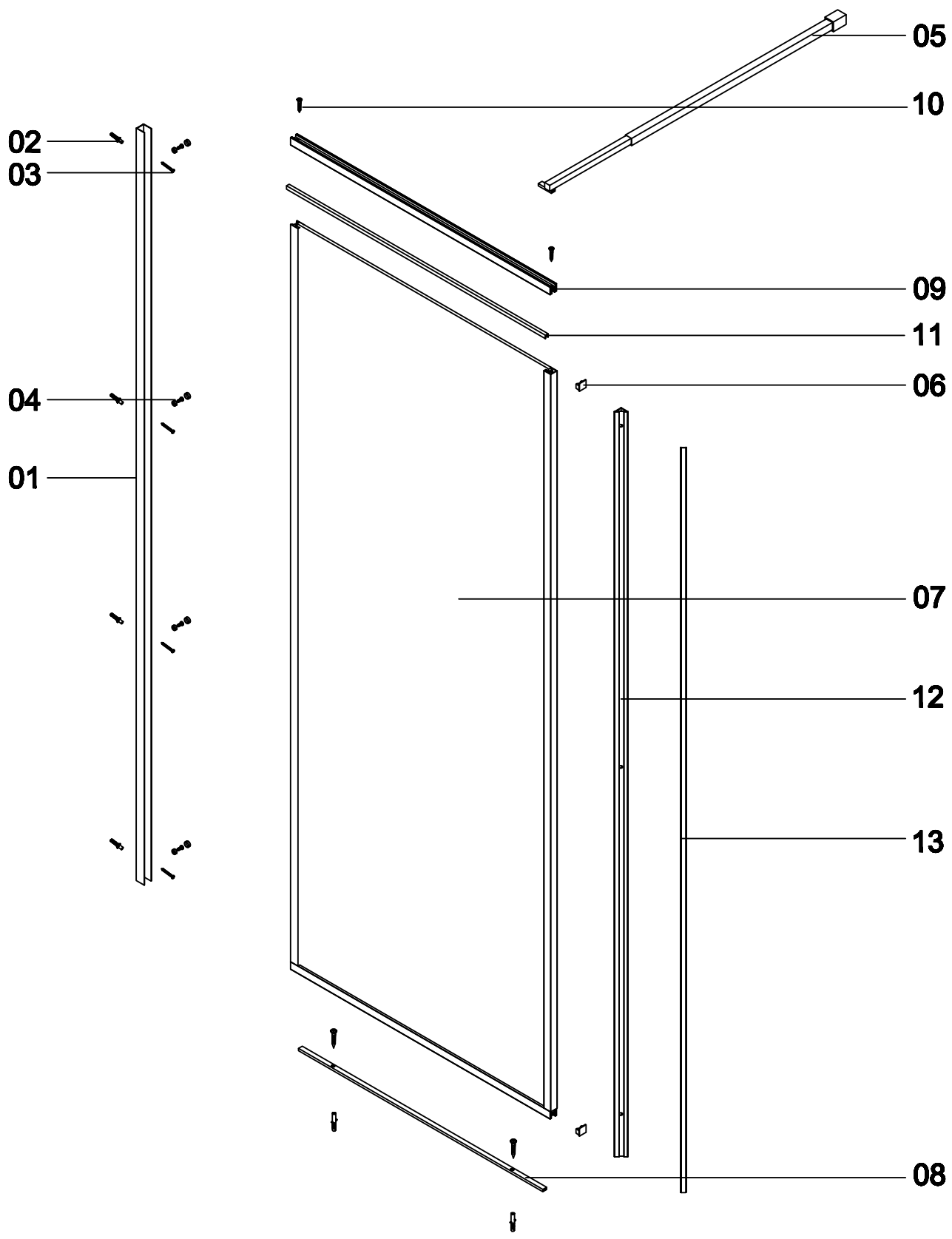

INSTALLATION ACCESSORIES LIST

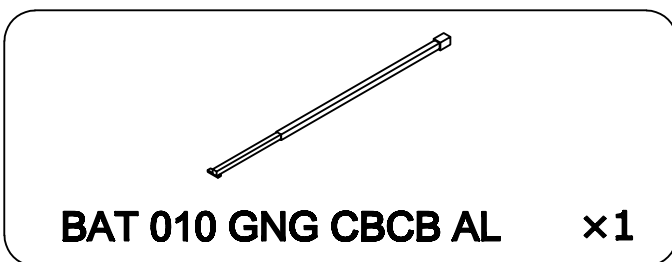
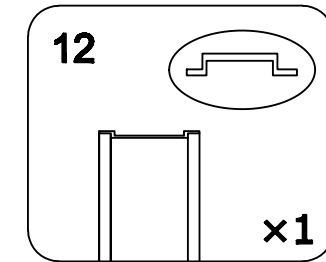
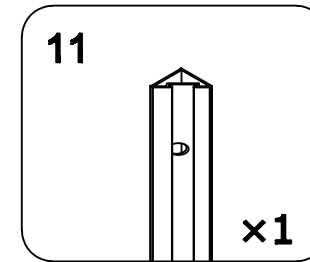
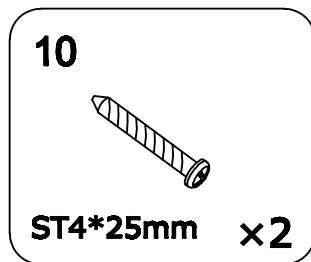
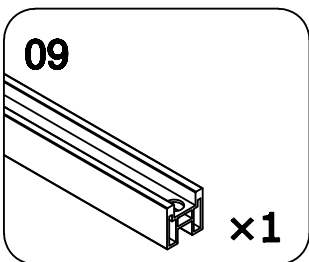
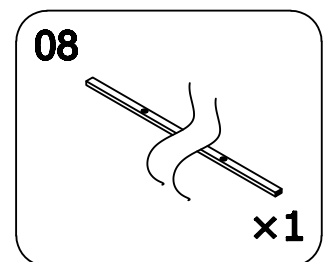
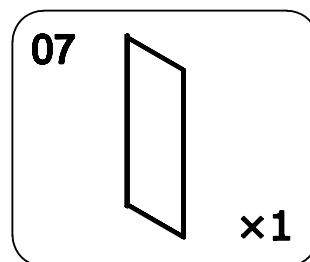
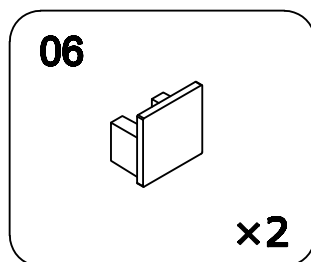
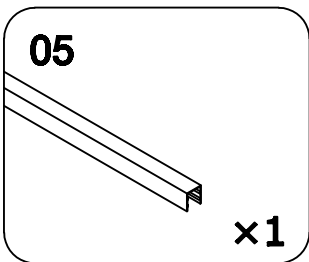
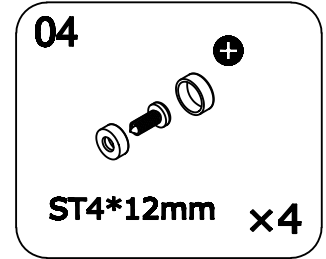
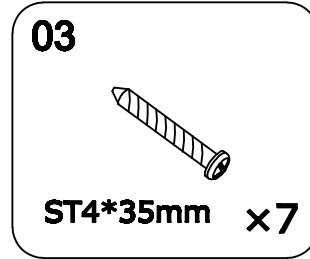
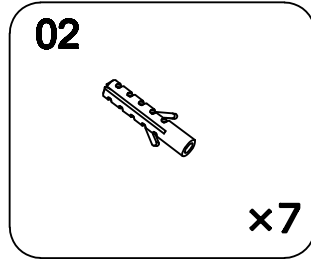
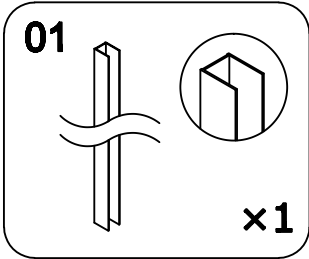

If you buy one fixed wall separately
please ignore part 11 12



**BAT 010 GNG CBCB AL
need to buy separately**

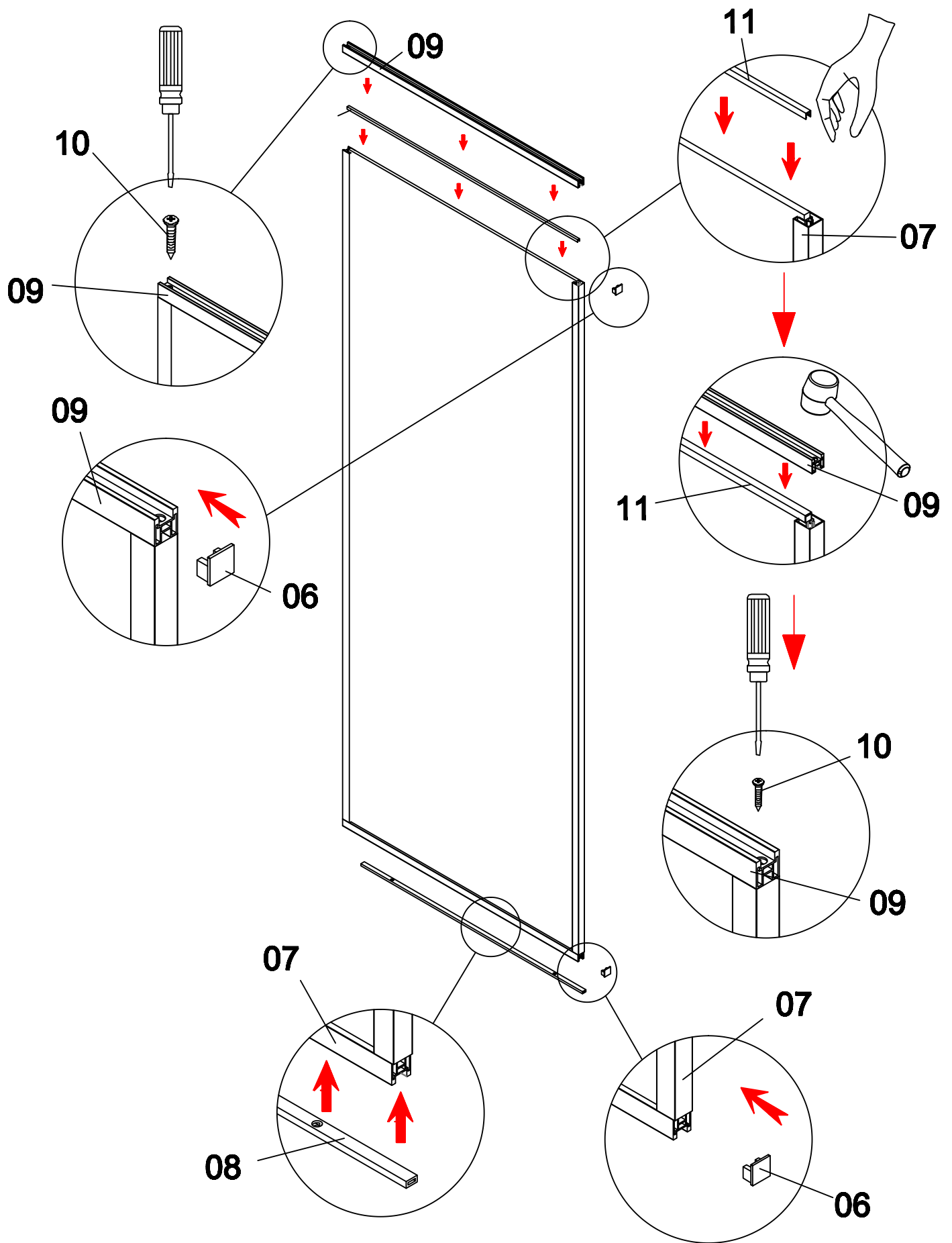

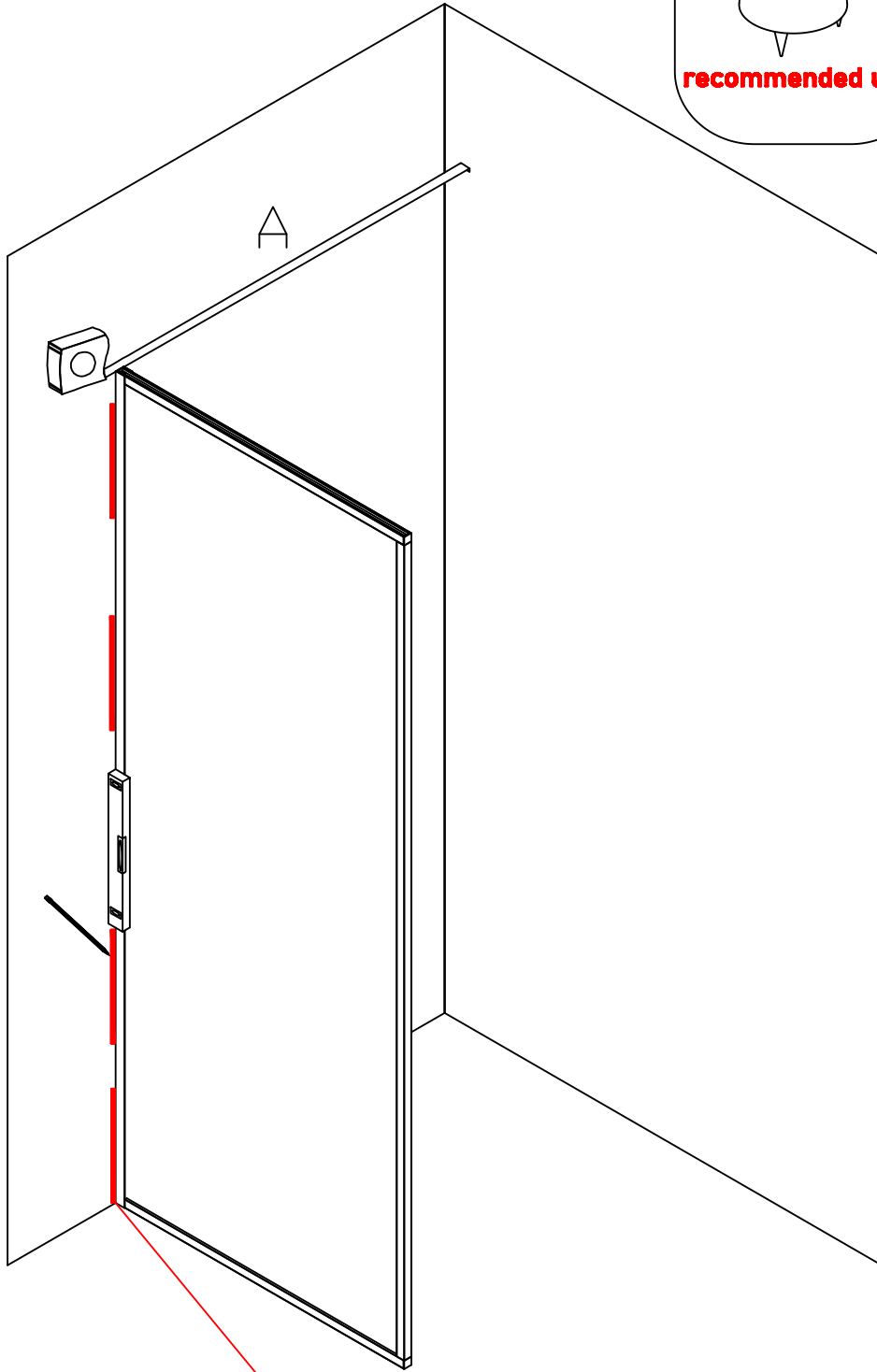

A=70-110cm

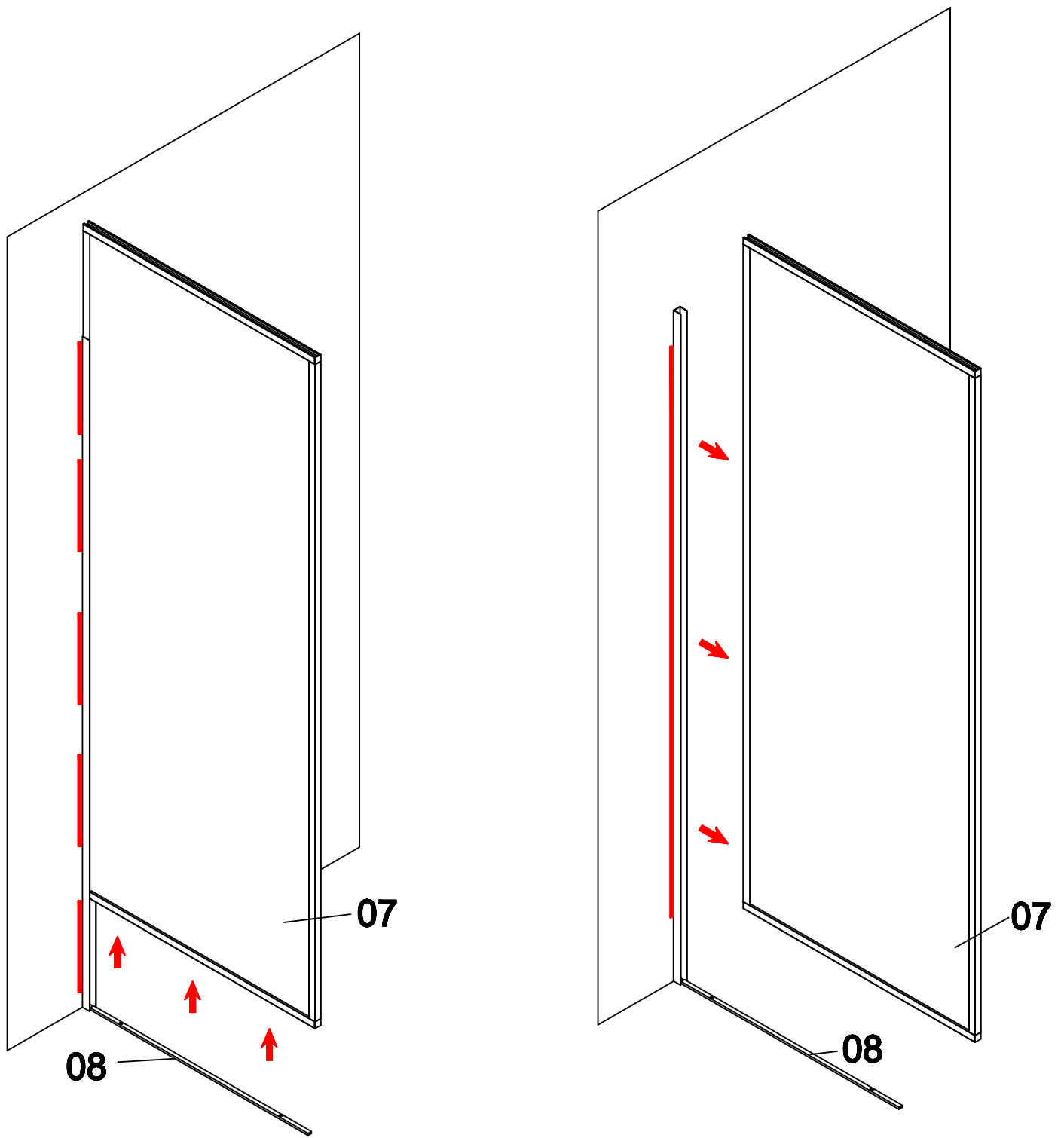

Gently move it up. Don't let "08" change position

