

FLUIDRA

# LUMIPLUS SPOTLIGHTS AND LAMPS

THE WORLD LEADER  
IN POOL LIGHTING

Underwater and decorative LED  
lighting solutions for any type  
of pool.

ASTRALPOOL 



AstralPool LumiPlus is the most extensive family in the market of underwater spotlights for public, commercial and residential pools. The entire LumiPlus range is made of high-quality LEDs and electronic components, and is manufactured entirely in the EU to European quality standards.

### The most comprehensive range for all pool types

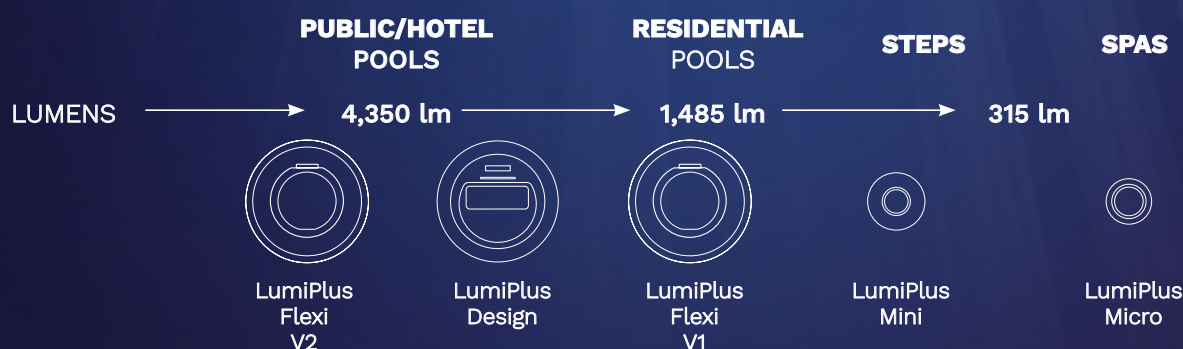

### The LumiPlus family delivers

- Greater energy efficiency.
- High performance spotlights with built-in top quality lighting (TQL) technology.
- Enhanced energy efficiency in a pool thanks to the use of LumiPlus DC lamps and spotlights run from a direct current power source (24 V DC).
- Unmatched control over all products in the range following the addition of the concept of the Internet of Pools (IoT) by Fluidra Connect.
- IP68 protection rating.

# LumiPlus

The world leader in pool lighting



LumiPlus has a wide range of products so that you can illuminate your pool whenever and however you want.

SPOTLIGHT

NEW

# LumiPlus Flexi

The LED solution that adapts to all types of pool





The new family of **LumiPlus Flexi** spotlights, FlexiNiche, FlexiSlim and FlexiRapid, is characterized by its great adaptability to any type of new-build and existing liner or concrete pool and can be fitted in a niche, on the surface or to bushing.

Maximum flexibility with the new LumiPlus Flexi system by AstralPool.

Ideal for public/hotel pools and residential pools in version V2 and V1, respectively.

**LumiPlus Flexi is made up of 3 components**

1	2	3
		
Light chip	Niche	Faceplate

The 3 components are required for the proper installation of FlexiNiche and FlexiRapid.

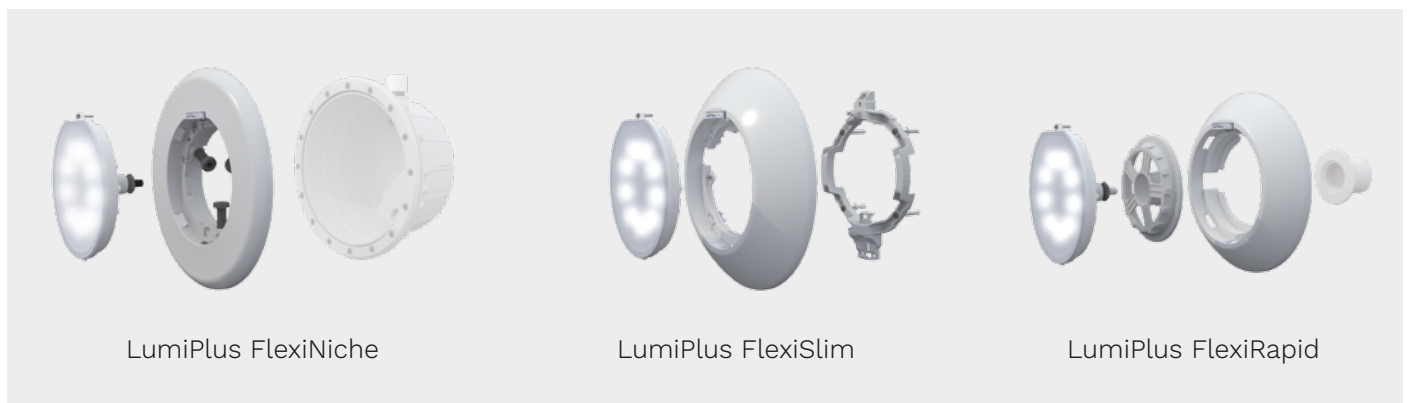

\* Resistant to salt water

# Maximum flexibility for configuring your spotlight



Power pack supplied with FLEXI DC spotlights

## FlexiNiche spotlights

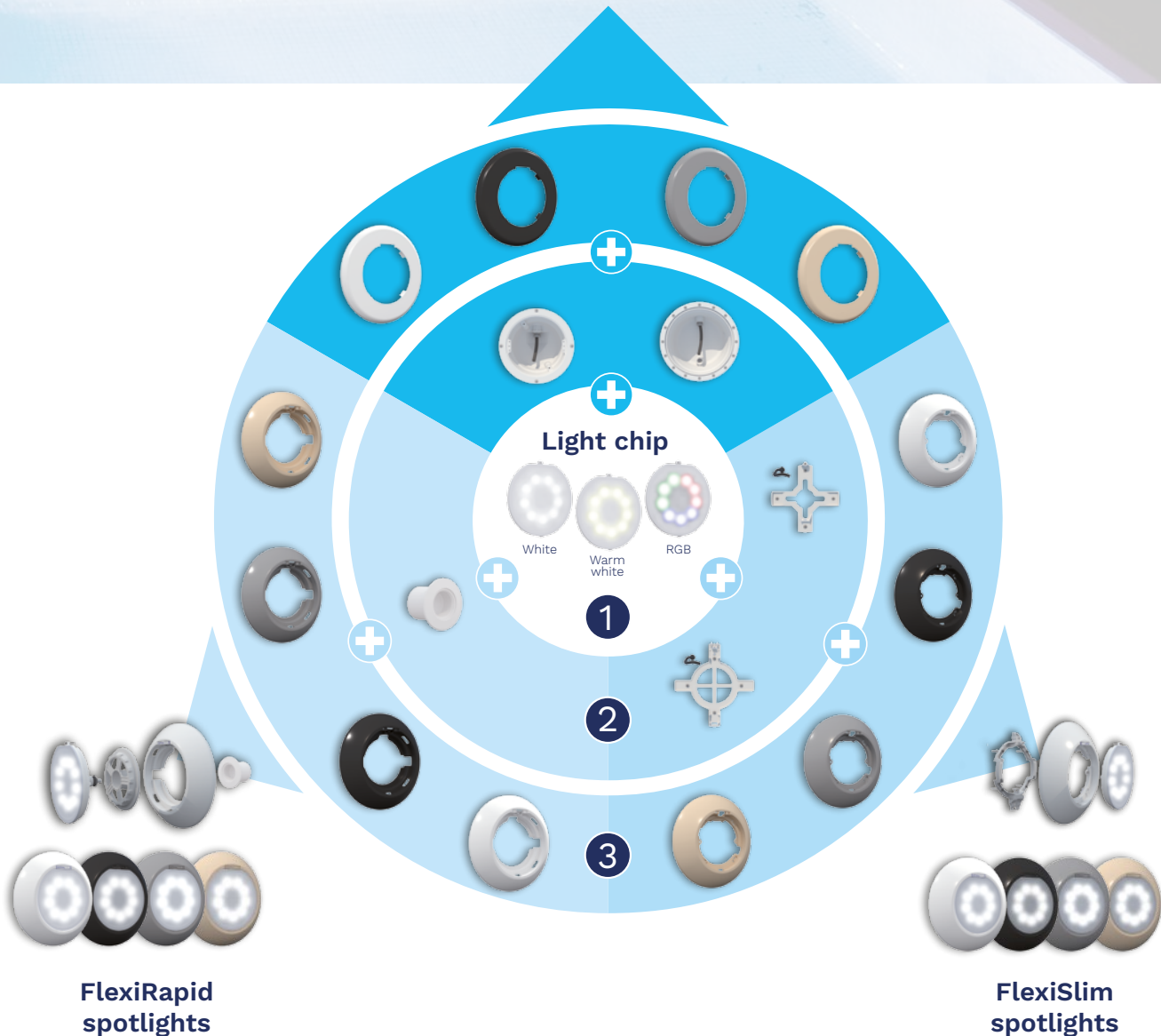

# LumiPlus Flexi

The easiest way of illuminating or renewing your pool's lighting.

Compatible with liner and concrete pools.

## Niche

1 Select color of light	V1 RESIDENTIAL	V2 PUBLIC/HOTEL	V1 RESIDENTIAL
	White 1,485 lm/RGB 1,100 lm	White 4,320 lm/RGB 2,544 lm	White 1,485 lm/RGB
	<ul style="list-style-type: none"> <li>White 16 W</li> <li>Warm white 16 W</li> <li>RGB 22 W</li> <li>Wireless 22 W</li> </ul>	<ul style="list-style-type: none"> <li>White 14 W</li> <li>Warm white 14 W</li> </ul>	<ul style="list-style-type: none"> <li>White 32 W</li> <li>Warm white 32 W</li> </ul>
	<ul style="list-style-type: none"> <li>RGB 43 W</li> <li>RGB-DMX 43 W</li> </ul>		<ul style="list-style-type: none"> <li>White 14 W</li> <li>Warm white 14 W</li> </ul>
	<ul style="list-style-type: none"> <li>V1 - AC (alternating current)</li> <li>V1 - DC (direct current)</li> </ul>	<ul style="list-style-type: none"> <li>V2 - AC (alternating current)</li> <li>V2 - DC (direct current)</li> </ul>	<ul style="list-style-type: none"> <li>V1 - AC (alternating current)</li> <li>V1 (direct)</li> </ul>

























2 Select a model according to the type of installation	Ø230 mm models	Ø180 mm models	Compatible with on Flat, Extra Flat spotlights by

3 Select faceplate color	Flexi Niche	Flexi Slim
	<ul style="list-style-type: none"> <li>WHITE</li> <li>ANTHRACITE GRAY</li> <li>LIGHT GRAY</li> <li>BEIGE</li> </ul>	

 Power pack supplied with FLEXI DC spotlights

## Walls

## Bushing

	<b>V2 PUBLIC/HOTEL</b>		<b>V1 RESIDENTIAL</b>		<b>V2 PUBLIC/HOTEL</b>	
1,100 lm	White 4,320 lm/RGB 2,544 lm		White 1,485 lm/RGB 1,100 lm		White 4,320 lm/RGB 2,544 lm	
 	 RGB 43 W	 	 White 32 W	 	 White 14 W	 
	 RGB-DMX 43 W		 Warm white 32 W	 	 Warm white 14 W	 
	 Wireless 22 W				 RGB 43 W	 
- DC current)	V2 - AC (alternating current)	V2 - DC (direct current)	V1 - AC (alternating current)	V1 - DC (direct current)	V2 - AC (alternating current)	V2 - DC (direct current)

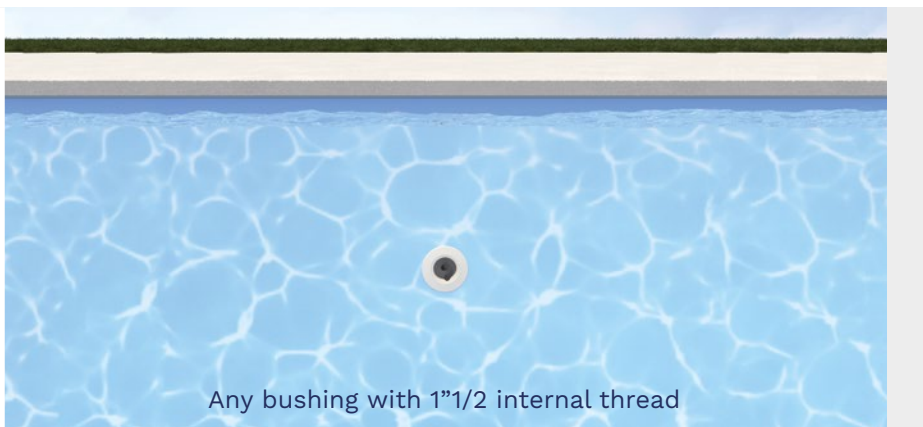
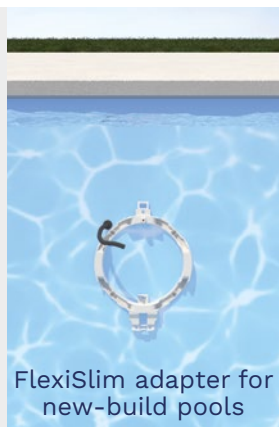
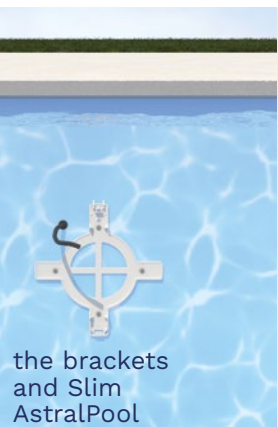

All light chips come with a 2.5 m power cable. Cables of 5, 10 and 15 m can be obtained separately.

 Compatible with Fluidra Connect



SPOTLIGHT

# LumiPlus Flexi

Maximum flexibility with the new LumiPlus Flexi system by AstralPool

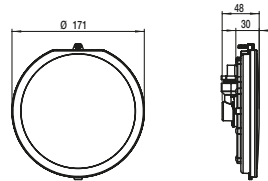

LumiPlus Flexi light chip

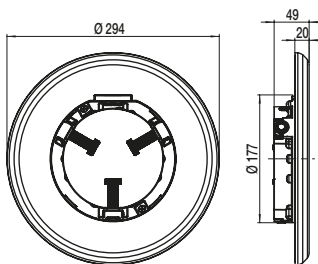

LumiPlus FlexiNiche

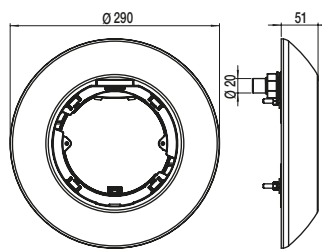

LumiPlus FlexiSlim

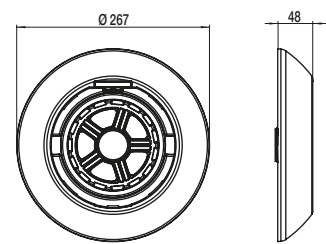

LumiPlus FlexiRapid

## LumiPlus Flexi LED configurator



<https://www.astralpool.com/configurador-led-lumiplus-flexi/>

## Control systems

The RGB model is compatible with the following control systems: LumiPlus Eco, LumiPlus Wireless, the LumiPlus LED app and LumiPlus Modbus Fluidra Connect.

## Installation

Scan the QR code and follow the instructions.



LumiPlus FlexiNiche



LumiPlus FlexiSlim



LumiPlus FlexiRapid

**Tips:** To correctly light a pool, it is advisable to install a LumiPlus Flexi V1 for every 20 m<sup>2</sup> of water surface and for every 25 m<sup>2</sup> in the case of the V2 version. The spotlights should always be installed completely submerged in water.



# Components required to install a LumiPlus Flexi - choose the components according to your requirements

- New-build pool – FlexiNiche or FlexiRapid version: 1+2+3
- New-build pool – FlexiSlim version: 1+3
- Upgrade without change of niche: 1+3

1 LIGHT CHIP		Code	Code
		V1	V2
	LumiPlus Flexi white AC light chip	71200	
	LumiPlus Flexi warm white AC light chip	71200WW	
	LumiPlus Flexi white DC light chip	71201	71202
	LumiPlus Flexi warm white DC light chip	71201WW	71202WW
	LumiPlus Flexi RGB AC light chip*	71203	71204
	LumiPlus Flexi RGB wireless AC light chip*	71205	
	LumiPlus Flexi RGB wireless AC light chip (1 LC + 1 Control Motion)	71206	
	LumiPlus Flexi RGB wireless AC light chip (2 LC + 1 Control Motion)	71207	
	LumiPlus Flexi RGB DMX AC light chip*		71208

All spotlights come with a 2.5 m power cable. Power cables of 5m, 10 m and 15 m available on request.  
 \* Choose the most suitable remote control (see control systems section).

2 NICHE		Code
	<b>Ø230 NICHE</b>	
	Niche for concrete pools	00349
	Niche for prefabricated pools with inserts	00364
	Niche for prefabricated pools without inserts	28887
	Niche for panel pools with inserts	23671
	Niche for panel pools without inserts	23670
	<b>RAPID INLET</b>	
	Inlet for concrete pools with 1 1/2" threaded Ø63 PN-6 piping	35418
	Inlet for concrete pools with 1 1/2" threaded Ø63 PN-10 piping	35421
	Inlet for liner prefabricated pools with 1 1/2" thread	27084
	Inlet for polyester prefabricated pools	38805

Other Ø230 and Ø180 niches also available (see catalog).

3 FACEPLATE		Code
	<b>NICHE Ø230 - Ø180</b>	
	White	71209
	Beige	71209CL090
	Light gray	71209CL129
	Anthracite gray	71209CL144
	<b>SLIM</b>	
	White	71210
	Beige	71210CL090
	Light gray	71210CL129
	Anthracite gray	71210CL144
	<b>RAPID</b>	
	White	71211
	Beige	71211CL090
	Light gray	71211CL129
	Anthracite gray	71211CL144

ASSEMBLY WITH WHITE FACEPLATE + WHITE LIGHT CHIP		Code	Code
		WHITE DC	WHITE DC
	Assembly with white faceplate + white Flexiniche light chip	71212	71213
	Assembly with white faceplate + white Flexislim light chip	71214	71215
	Assembly with white faceplate + white Flexirapid light chip	71216	71217

SPOTLIGHT

# LumiPlus Design

A perfect finish





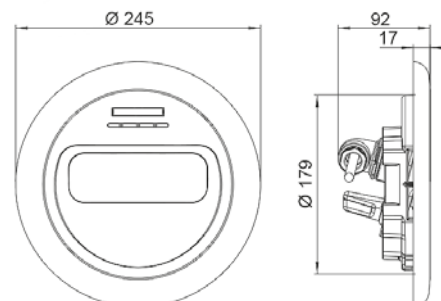

Available in two finishes, pure white or stainless steel effect, its design blends in perfectly with any pool environment.

LumiPlus Design spotlights are set at an angle of 14° to better light up a pool floor and reduce outdoor light pollution.

LumiPlus Design spotlights improve luminous efficacy (lm/W) by around 40% in comparison with the main LED solutions in the market.



Faceplate	WHITE 		RGB  		RGB DMX 	
	White	Stainless steel effect	White	Stainless steel effect	White	Stainless steel effect
Code	59807	59805	59803	59801	59811	59809
Consumption	45 W (50 VA)		40 W (55 VA)		40 W (55 VA)	
Luminous flux	4,320 lm		2,544 lm		2,544 lm	

Colors available: Warm white

**Tips:** To correctly light a pool it is advisable to install a lamp from the LumiPlus range for every 25 m<sup>2</sup> of water surface.

The spotlights are not supplied with a niche, so a suitable niche must be selected for full spotlight assembly. The spotlights should always be installed completely submerged in water. The spotlight is not supplied with a niche. Only compatible with a ø180 mm niche.

### Control systems

The RGB model is compatible with the following control systems: LumiPlus Eco, the LumiPlus LED app, LumiPlus Modbus Fluidra Connect and LumiPlus TOP.

\*Resistant to salt water.

# LumiPlus PAR56

The efficient solution for upgrading your pool to LED lighting



 Power pack supplied with PAR 56 DC spotlights and white lamps.





LumiPlus lamps deliver a lighting performance up to three times higher and greater energy efficiency than those currently available in the market.

Their enhanced luminous flux and optical efficiency will bring out the best in any facility.

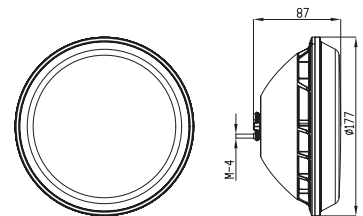
Thanks to their technology, light can be evenly distributed across a pool. LED white light lamps are ideal for replacing PAR56 300 W halogen lamps as they save over 90% in power consumption and have a service life of up to 100 times longer than a PAR56 halogen lamp.



\* DC model measurements

	WHITE - DC		RGB 	
Version	V1 	V2 	V1	V2
Code	67515	67516	56001	43411
Consumption	14W (14 VA)	32 W (32 VA)	22W (29 VA)	43W (54 VA)
Luminous flux	1,485 lm	4,320 lm	1,100 lm	2,544 lm
Colors available	Warm white			

**How to change your lamp**  
Scan the QR code and follow the instructions.



**Control systems**  
The RGB model is compatible with the following control systems: LumiPlus Eco, LumiPlus Wireless, the LumiPlus LED app, LumiPlus Modbus Fluidra Connect and LumiPlus TOP.

**Tips:** To correctly light a pool it is advisable to install a LumiPlus PAR56 V1 for every 20 m<sup>2</sup> of water surface and for every 25 m<sup>2</sup> in the case of the V2 version. The lamps do not include a cable. Must always be submerged in water.

\*Resistant to salt water.

SPOTLIGHT

# LumiPlus PAR56

The stainless steel solution





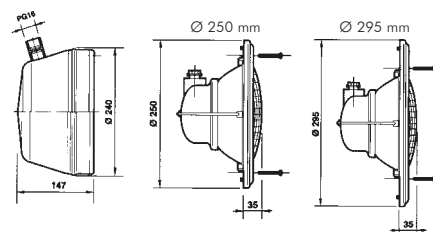

Range of projectors made entirely of AISI-316 stainless steel with LED lamps. Supplied with a 2.5 m cable with a PG16 thread and PG16 to M25 converter.

Lamp assembly fastened to the niche using screws.

For full projector assembly, the niche must be purchased separately.



	WHITE Ø250 mm faceplate		RGB 	
Version	V1 	V2 	V1 	V2 
Code	71659	71661	54094	54092
Consumption	14W (14 VA)	32W (32 VA)	27 W (37 VA)	48 W (64 VA)
Luminous flux	1,485 lm	4,320 lm	1,100 lm	2,544 lm
Colors available	Red, Green, Blue, Neutral White and Warm White			

\* Also available 295 mm in diameter.  
Niche to be purchased separately for all models.

### Control systems

The RGB model is compatible with the following control systems: LumiPlus Eco, LumiPlus Top, the LumiPlus LED app and LumiPlus Modbus.

**Tips:** To correctly light a pool it is advisable to install a LumiPlus PAR56 V1 for every 20 m<sup>2</sup> of water surface and for every 25 m<sup>2</sup> in the case of the V2 version. The lamps do not include a cable. Must always be submerged in water.

SPOTLIGHT

# LumiPlus Mini and Micro

Ideal for small spaces



New range of mini and micro LED spotlights with greater light intensity, of higher quality and better energy efficiency.

Their design now makes for a more seamless fit in pools and they are easier to install than ever before.

Suitable for installation in steps, bushings, niches and spas.



Light	MINI V3 – MINI V2				MICRO			
	WHITE		RGB		WHITE		RGB	
Faceplate	White	Stainless steel	White	Stainless steel	White	Stainless steel	White	Stainless steel
Consumption	4 W (6 VA)		4 W (6 VA)		6 W (9 VA)		4 W (4 VA)	
Luminous flux	315 lm		186 lm		315 lm		186 lm	

The faceplate for Mini V3 spotlights is in a stainless steel effect.  
The faceplate for Mini V2 and Micro spotlights is made of 316 stainless steel.





### Control systems

The RGB model is compatible with the following control systems: LumiPlus Eco, the LumiPlus LED app, LumiPlus Modbus Fluidra Connect and LumiPlus TOP.

\*Resistant to salt water. Check version.

# LumiPlus Control systems

	SYSTEM	CODE	DESCRIPTION	SPOTLIGHTS
LumiPlus RGB ECO		32458	<p><b>The simplest and most inexpensive color change system.</b></p> <p>LumiPlus ECO is a push-button switch that has 14 operating modes: 7 fixed colors and 7 different color sequences. Each time the push button is pressed, the color or sequence will change. By pressing for several seconds, the light is white.</p> <p>The push button must be sized to withstand the power consumed by the number of lamps in a pool.</p> <p>Maximum charge of 700 VA. Must be connected in the transformer's primary winding.</p>	Any LumiPlus RGB spotlight.
LumiPlus WIRELESS	LumiPlus Motion Control 	59125	<p><b>CONTROL of color changes in your hands.</b></p> <p>The LumiPlus Control Motion remote control enables wireless spotlight control with direct on/off options, 12 color changes, 8 sequence changes and their speed. In addition, it is sensitive to movement so that colors and sequences can be turned on by moving it vertically or horizontally.</p> <p>This device is only compatible with LumiPlus wireless spotlights. It can control two wireless spotlights.</p>	PAR56 V1 RGB Wireless, S-Lim V1 RGB Wireless, Rapid V1 RGB Wireless spotlights
	LumiPlus Wireless Range Extender 	64633	<p>It amplifies the signal that LumiPlus Control Motion sends to the spotlights using the wireless control system. Ideal for facilities whose architectural features or spotlight installation makes it hard for the LumiPlus Control Motion signal to reach the wireless spotlights properly.</p>	
LumiPlus RGB TOP		27818 + 41988	<p><b>The LumiPlus TOP system for the remote control of pool color changes.</b></p> <p>System comprising the modulator (code 27818) and remote control (code 41988) that enables the control of a large number of spotlights. The modulator has an antenna with a range of 50 meters able to receive signals from the remote control, which must be purchased separately. The LumiPlus TOP system makes it possible to:</p> <ul style="list-style-type: none"> <li>• Switch spotlights on and off.</li> <li>• Select colors: 12 standard colors available.</li> <li>• Select sequences: 8 sequences available.</li> <li>• Select the speed of sequences: 8 speeds available.</li> </ul> <p>They are supplied separately. A total of 10 LumiPlus modulators can be synchronized.</p>	Any LumiPlus RGB spotlight.
	Existing installation 	59131	<p><b>Control your pool's lighting from your smartphone.</b></p> <p>App for controlling LumiPlus lamps and spotlights from an Android or iOS smartphone or tablet.</p> <p>If your pool has a LumiPlus modulator (code 27818), you can control your LumiPlus lamps or spotlights from your smartphone or tablet by just installing the LumiPlus Wi-Fi access point together with the modulator. The LumiPlus LED app should only be installed as an additional feature to the LumiPlus modulator. It has a range of 12 colors and 8 sequences of color changes.</p>	
LumiPlus LED app LumiPlus Wi-Fi	New installation 	59132	<p>Free app that can be downloaded from the following addresses according to operating system.</p> <p>Apple: <a href="http://www.lumiplusled-ios.astralpool.com">www.lumiplusled-ios.astralpool.com</a> Android: <a href="http://www.lumiplusled-android.astralpool.com">www.lumiplusled-android.astralpool.com</a></p> <p>Available for:</p>    	To control any LumiPlus RGB spotlight

SYSTEM		CODE	DESCRIPTION	SPOTLIGHTS
LumiPlus Modbus FLUIDRA CONNECT 	Existing installation	 57434	<p><b>Control your pool lighting anywhere, anytime.</b></p> <p>The Modbus protocol enables the control of the LumiPlus modulator. It can be used to switch the spotlights on and off, change their colors and sequence speed, and set the time for putting the spotlights in sleep mode.</p>	Can control any LumiPlus spotlight
	New installation	 +  57435	<p>Download the Fluidra Connect app for instant information about the state of your pool 365 days a year. Fluidra Direct means peace of mind, comfort and entertainment. In addition to controlling spotlights, LumiPlus lets you control your pool's filtration, water treatment, etc. through the Modbus protocol.</p> <p>The LumiPlus Modbus should only be installed as an additional feature to the LumiPlus modulator (code 27818) for correct installation and operation.</p>	

LumiPlus RGB DMX	RGB DMX Modulator	 41107	<p><b>System for preparing lighting scenes for fountains and large aquatic spaces</b></p> <p>DMX modulator for LED spotlights/12 V AC</p> <ul style="list-style-type: none"> <li>DMX receiver for the range of PAR56, S-LIM and Design spotlights.</li> <li>It decodes the commands received from the DMX controller and makes the spotlights work accordingly. Operates at 12V AC.</li> </ul>	Can control any LumiPlus spotlight RGB-DMX
	RGB-DMX power pack	 52142	<p>Product designed exclusively for use with V2 and V3 Mini LED and RGB DMX Micro spotlights. The power pack can control up to 9 spotlights. It receives commands from the system's DMX controller (Astral DMX 41329 or Astral DMX Pro 41330) via the DMX bus and makes the spotlights that are connected work. The power pack has been designed to be used solely with DMX protocol and 24 V DC DMX controllable components by AstralPool.</p>	
	DMX Controller	 41329	<p>System that makes it possible to single out lights individually or by groups. Total control for fountain lighting from a PC or through a programmable, stand-alone module. It comprises the Astral DMX module (USB-DMX interface) and intuitive software, which together give users full control over a single spotlight or a group of spotlights. Any particular color can be chosen from among more than 16 million colors. The system is an ideal solution for creating displays that almost last forever with spectacular results. Advantages and benefits of this system:</p> <ul style="list-style-type: none"> <li>Very accurate (and coordinated) control over lighting (light and intensity).</li> <li>Can handle many units that run separately or in combination with each other.</li> <li>Great versatility for creating sequences.</li> <li>The AstralPool DMX system does not require any additional wiring on spotlights with PAR 56 lamps.</li> </ul>	
	DMX PRO controller	 41330		



## Fluidra Connect

Comprehensive solution for the control of all pool settings wherever you are

The background of the entire page is a deep blue, monochromatic image of an underwater scene. Sunlight rays penetrate from the top, creating a series of vertical, slightly blurred lines of light that fan out as they descend. The water's surface is visible at the top, with intricate, swirling ripples and light reflections that create a sense of depth and movement. The overall atmosphere is serene and clean, emphasizing the fluidity of water.

# FLUIDRA

For further information:  
[www.astralpool.com](http://www.astralpool.com)

FLUIDRA S.A.  
[www.fluidra.com](http://www.fluidra.com)