

ASSEMBLY INSTRUCTION

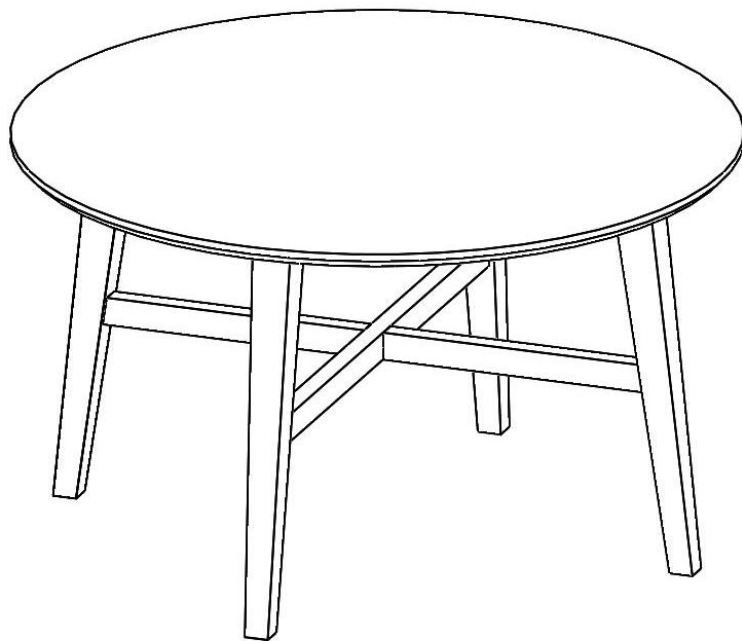



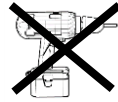
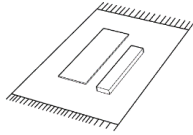
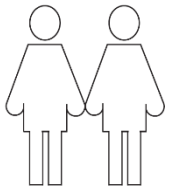

# FILIPPA COFFEE TABLE ROUND

Ø90



**ROWICO**  
HOME

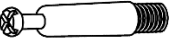

List of part		
	Description	N.o of pcs
A	Bordstopp/Table top	1
B	Bordsben/Table legs	4
C	Tvärstag/Stretcher rail	2
List of hardware		
a	 Allen key N.o 6	1
b	 L 32 x Ø8 mm	12
c	 Ø15	4
d	 Ø35 Förmonterad/Pre assembled	4
e	 M8 * L 58 mm	4
f	 M6 * L 40 mm	4
g	 Felt pad 25 x 25 mm	4

Attention:

Spänn inte kopplingsbeslagen innan benställningen är monterad på bordet. / Do not tighten the cam lock nut until the leg frame is mounted.

Maintenance before use:

Innan användning skall ytan behandlas med en transparent olja och regelbundet efter behov minst 2-3ggr per år. / Before use, the surface needs to be treated with a clear oil and then regularly when needed or at least 2-3 times per year.

## Step 1

Montera träplugg (b), skruv(e) och(f) och kopplingsbeslag (c)./  
Assemble wooden dowel (b), screws (e) and (f) and camlock nut (c).

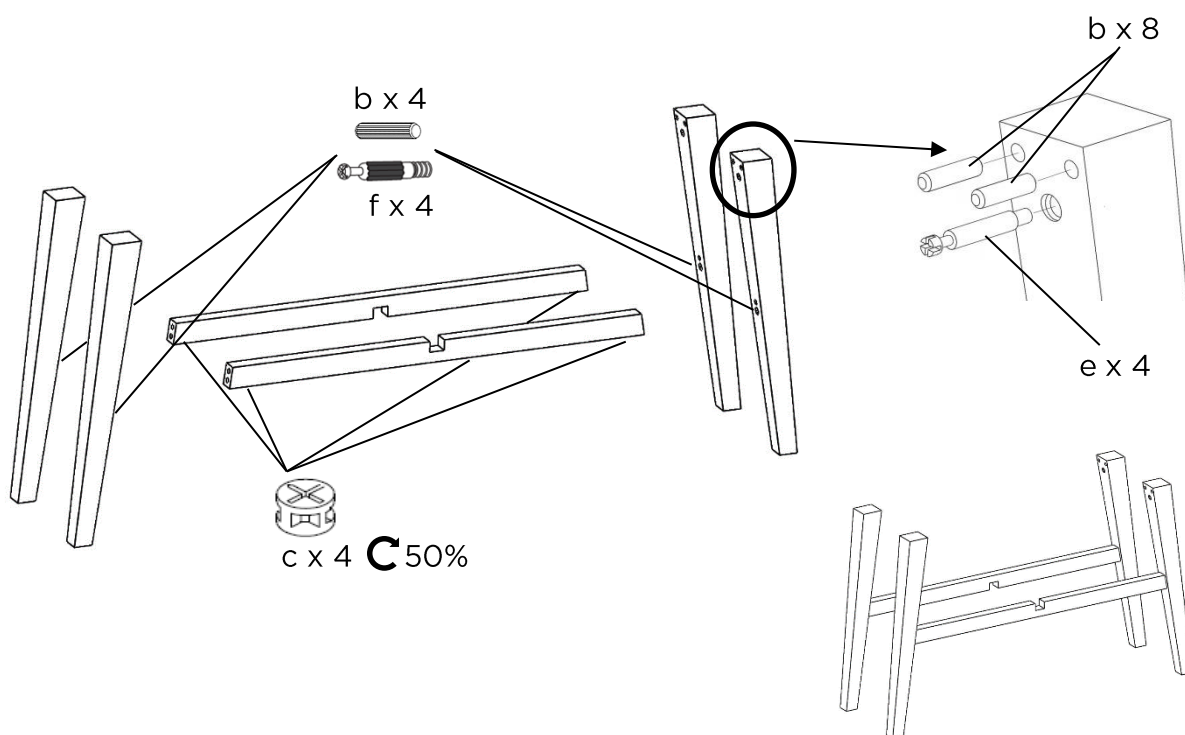

## Step 2

Lägg ihop tvärstagen så de bildar ett kryss och tryck fast benstativet i bordet med hjälp av träpluggarna. Spänn sedan kopplingsbeslagen (c) och (d) och montera möbeltassarna (g).

Assemble the crossbars together so that they form a cross and press the leg frame into the table using the wooden plugs. Then tighten the camlock nuts (c) and (d) and assemble the felt pads (g).

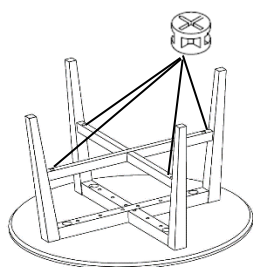
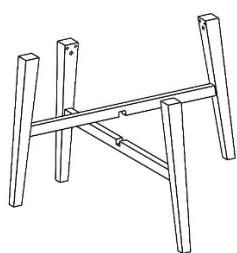

c x 4 **C** 100%

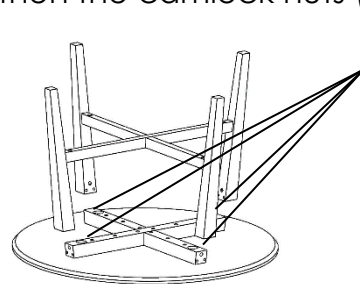

d x 4 **C** 50%

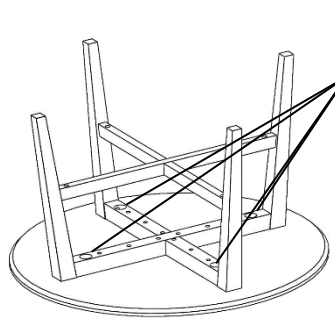

d x 4 **C** 100%