

CONNECTOR INSTALLATION INSTRUCTIONS
Amphe-PV H4 Plus™ Connectors

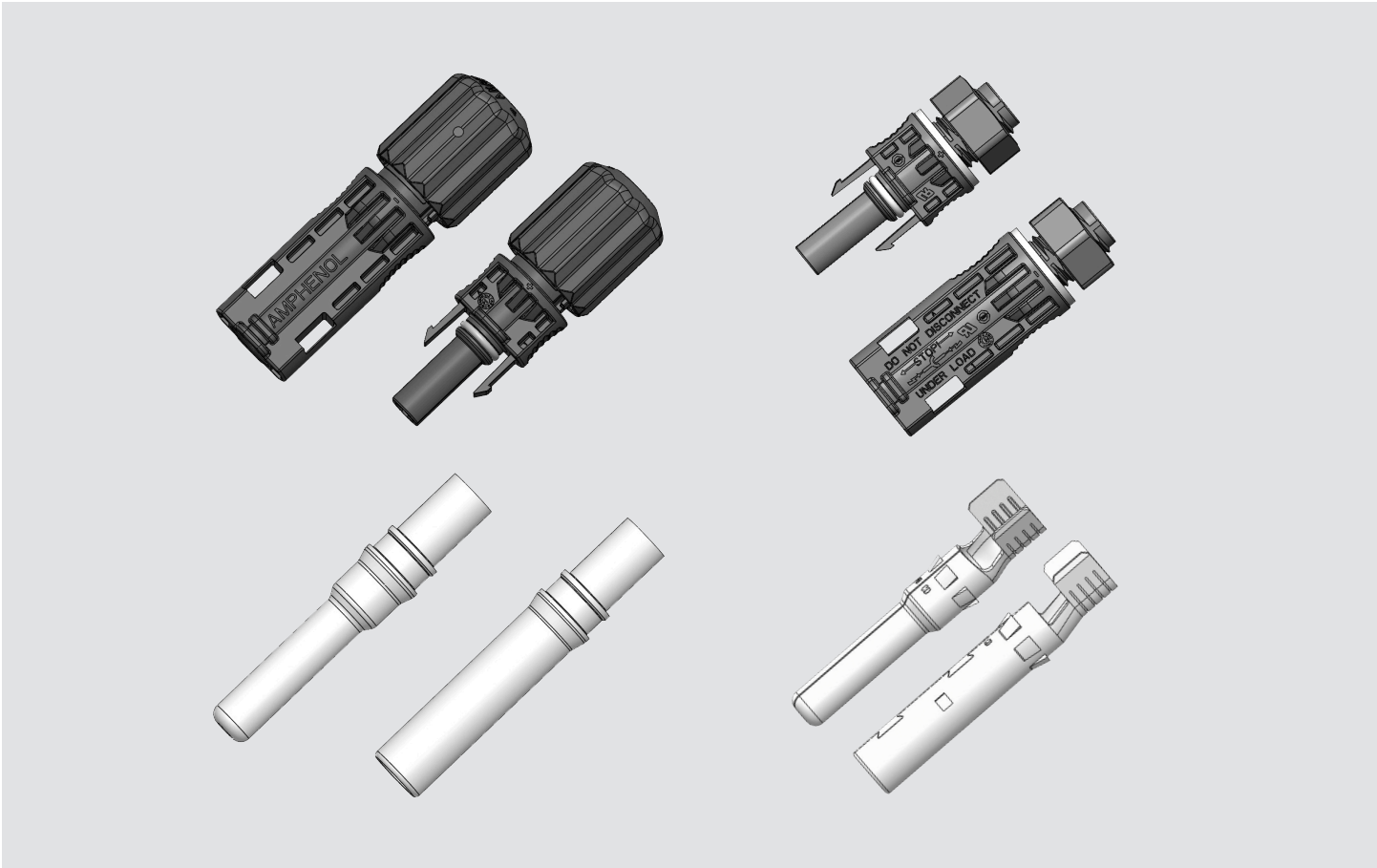









Table of Contents

1.	Safety & Caution	3
2.	Technical Data	4
3.	Connector and Tool Selection	4
4.	Assembly Process of Terminal and Cable	6
4.1	Applicable Cable Selection	6
4.2	Crimping Tool Selection	6
4.3	Adjust the Crimper for Suitable Crimping Force	7
4.4	Crimping Quality Verification	7
4.5	Crimping	9
4.6	Crimping Tool Operation	10
5.	Connector Assembly Process	10
5.1	Cable End Assembly	10
5.2	Panel Mounted End Assembly	11
5.3	Protection Before Mating the Male and Female End	13
5.4	Mating the Male and Female Connectors	13
5.5	Unmating the Male and Female Connectors	14
6.	Cable Routing	14
7.	Notes on Storage	15
8.	Revision Records	15
Appendices		
A.	Chemicals Exposure Check List.....	16

Part 1: Safety & Caution

-  1. The connector must be isolated and disconnected from the power supply during the assembly or disassembly process.
-  2. Do not disconnect under load.
-  3. The mated Amphenol PV connectors are IP68 (under water 1meter for 24 hour) compliant in the function of sealing. However please prevent connectors from being immersed in water.
-  4. The product may be assembled and installed only by qualified and trained specialists who observe the applicable safety regulations.
-  5. Amphenol declines any liability in the event of failure to comply with this assembly instruction.
-  6. Connectors not made by Amphenol which can be mated with Amphenol elements and in some cases are also described as “Amphenol-compatible” do not conform to the requirements for safe electrical connection with long-term stability, and for safety reasons must not be plugged together with Amphenol elements. Amphenol can therefore accept no liability for damage which occurs as a result of mating these connectors that lack Amphenol approval with Amphenol elements.
-  7. Please be aware that this 3rd Party laboratory test is just a reference for application. It is the customer’s responsibility to validate connector durability in system function at specific and extreme environment conditions, we recommend customer to consider a margin in actual applications with high current situations that can lead to overheating.
-  8. Amphenol warns customers and users to avoid exposure of chemical substances in the connector application environment. Chemical compatibility of thermoplastics e.g. Lexan polycarbonate is dependent on contact time, temperature, concentration and stress (external stress to which the application is subjected to). Chemicals exposure can result in discoloration, softening, swelling, cracking or loss of properties of the thermoplastics. DO NOT allow the connectors contact any chemicals including below but not limited as they may cause stress cracking. Grease, Oils, Mold Release Agent, Binder, Alcohols, Fatty hydrocarbons, Acid, Aromatic hydrocarbon, Ketones, Halogenated hydrocarbon, Organic solvents including Gasoline, Kerosene, Ethyl acetate and others, Cleaning agents. Detailed refer to file. See Appendix A or file: WI -S047-ENG (Chemicals Exposure Vcheck List).

The list of chemicals provided by Amphenol does not include all chemicals that may appear in the production and subsequent use of customers. Customers are requested to verify their impact on products and take corresponding to risk management measures for chemical contamination. Amphenol does not accept any return requests for products contaminated with chemicals.

Part 2: Technical Data

Rated Voltage	1500V DC		
Rated Current	TUV (IEC 62852)	25A @85°C; (2.5mm ²)	
		35A @85°C; (4.0 mm ²)	
		45A @85°C; (6.0mm ²)	
		65A @85°C; (10.0mm ²)	
	UL (UL6703)	15A (14AWG)	
		20A (12AWG)	
		30A (10AWG)	
		50A (8AWG)	
Protection Degree:	IP68(1m,24) , IP2X,		
	IP68 mated (1m@24H) and IP2X unmated		
Safety Class:	II		
Operation Temperature Range:	-40°C to +85°C		
License Holder:	Amphenol Industrial Operations		

Part 3: Connector and Tool Selection





3.1: Connector Part Number Code Logic

Product	Type	Gender		Connector Type		Terminals - Cable Size		Certifications		Packaging		Contact	
H4	S (Amphe-PV H4 Plus)	F	Female +	C	Cable Connector	0	Less Contacts	T	TUV	I	1pcs/bag, 800pcs/box	S	Stamped & Formed
		M	Male -	M	Panel Mounted M12	2	2.5mm ² /14AWG	D	TUV & UL	C	100pcs/bag 800pcs/box	Blank	Cold Formed
				D	Manual Unlock Cable Connector	4	4mm ² /12AWG& 6mm ² /10AWG(S&F); 4mm ² /12AWG(CF)			M	400pcs/bag 800pcs/box		
				B	Manual Unlock Panel Mounted M12	6	6mm ² /10AWG(CF)						
						8	10mm ² /8AWG						



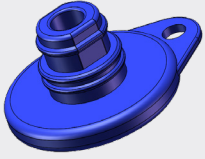

3.2: S&F Contact Part Number Code Logic (Reel Type Only)

Product	Type	Gender		Terminals - Cable Size		Packaging		Variations	
UTX	F	Stamped & Formed Contact		F	Female +	2	2.5mm ² /14AWG	R	2000PCS/reel
				M	Male -	4	4mm ² /12AWG&6mm ² /10AWG		

3.3: Tools List

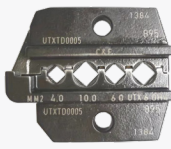
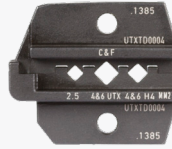
(2.5/4.0/6.0mm ²) Strip tool for 2.5/4/6mm ² PV cable	H4TS0000	
Wrench tool for Amphe-PV H4 Plus	H4TW0001	
Contact depth inspection tool for 2.5/4/6mm ²	H4TT0002	
Contact depth inspection tool for 10 mm ² /8AWG	H4TT0003	
Protection cap for female connector	UTXPF	
Protection cap for male connector	UTXPM	

Crimping Tool

Tool	UTXTC0003	UTXTC0004	UTXTC0005
Crimping Die	UTXTD0003 	UTXTD0005 	UTXTD0004 
Locator	UTXTPO002 	UTXTPO004 	UTXTPO003 
Hand Shank			

Part 4: Assembly Process of Terminal and Cable

4.1: Applicable Cable Selection

- 4.1.1 Only suitable for the PV cable with cooper conductor. Tin coated wire of conductors is recommended.
- 4.1.2 The cable OD range from $\varnothing 5.0\text{mm}$ to $\varnothing 7.8\text{mm}$, the number of conductor strands is from 7 to 140 for 2.5/4.0/6.0mm² connector.
The cable OD range from $\varnothing 7.5\text{mm}$ to $\varnothing 8.8\text{mm}$, the number of conductor strands is from 19 to 77 for 10mm²/8AWG connector.
- 4.1.3 This connector is only suitable for cables with EN 50618, IEC62930, UL 4703 and USE-2 certification.
- 4.1.4 For use with others cable, do crimping and sealing performance verification first or contact Amphenol.

4.2: Crimping Tool Selection

Please choose the crimping die based on the terminal and cross section area of cable conductor. Use of the wrong crimping die may lead to the connector overheating, and lower the reliability of the connector.

Crimping Die Layout

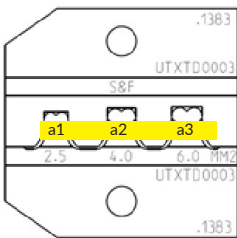

Crimping die PV-693782-004

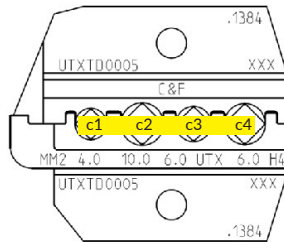

Crimping die PV-693782-000

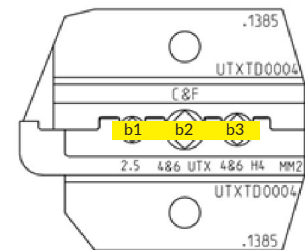

Crimping die PV-693782-001

Cold Formed Contact		Cable Conductor IEC 60228 class 2,5,6		Crimp Die		Crimping width height (mm)	Pull force (N)	Conductor Compression Ratio
Type	Crimp Barrel	AWG	Cross section area (mm ²)	Part number	Position			
	OD (mm)					ID (mm)		
C&F 2.5	3.50	2.30	14	2.08	UTXTD0004	b1	2.40	>223
C&F 4	4.60	3.05	12	3.31	UTXTD0005	c1	3.05	>312
C&F 6	6.00	3.76	10	5.26	UTXTD0005	c3	4.10	>356
C&F 10.0	6.20	4.70	8	8.20	UTXTD0005	c2	4.20	>401

Stamping Con- tact Size	Cable Conductor IEC 60228 class 2,5,6		Crimp Die		Crimping		Pull force min (N)	Conductor Compression Ratio
	AWG	Cross section area (mm ²)	Part number	Position	Height (mm)	Width (mm)		
S&F 2.5	14	2.08	UTXTD0003	a1	2.05	3.40	>223	
S&F 4&6	12	3.31		a2	2.39	4.00	>312	
	10	5.26		a3	2.65	4.25	>356	

4.3: Adjust Crimping Tool

If needed, following below steps to adjust the pressure force to optimize crimping.

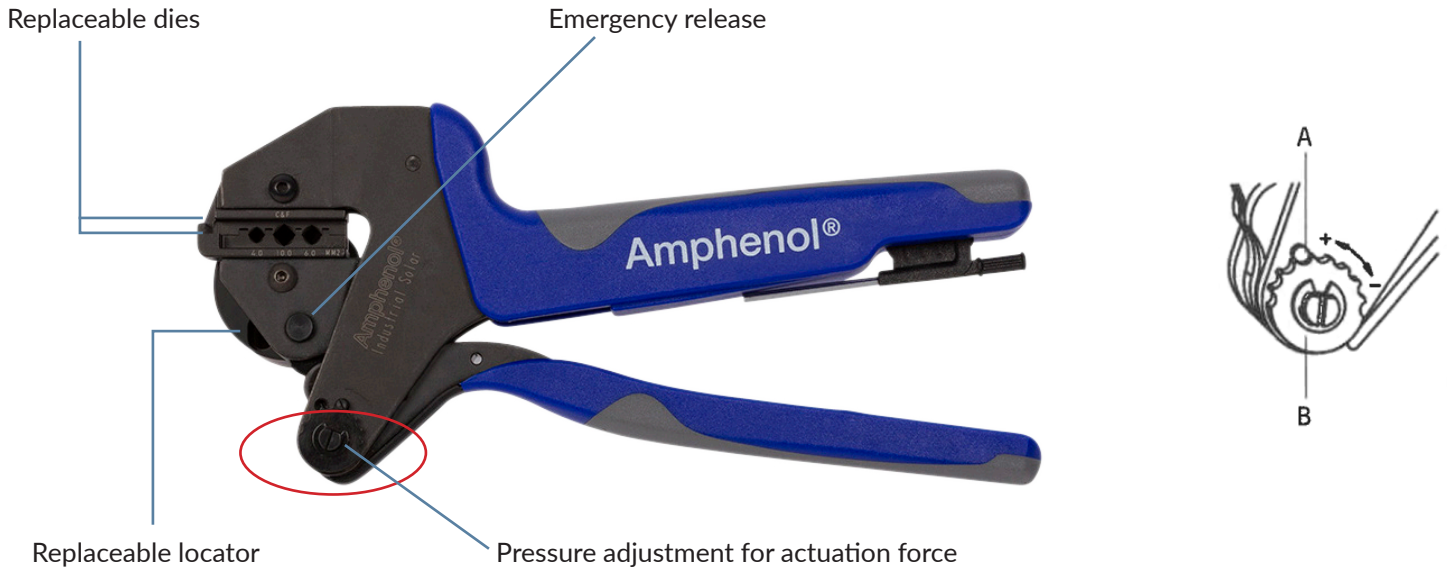

- I. Loosen the screw (A) with a screwdriver.
- II. Turn the dial counter (B) clockwise (+) to increase the crimping force. This also reduces the jaw spread.
- III. Turn the dial counter clockwise (-) to reduce the strength of the crimping force. This also increases the jaw spread. Do not exceed 180N.
- IV. After changing the setting, make sure the screw is adequately tightened.

4.4: Crimping quality verification

Great variations exist in the diameter, quantity and cross section of strands between PV cables made by different manufacturers, so the above dimensions are only for reference. In order to get quality crimping, please verify the pull force and crimping cross section.

Pull force between the contact and cable should meet to UL486a-486b, refer to the table in section 4.2

The cross section inspection standard:

- The crimp shall have all cable strands compressed into a hexagonal shape with minimal voids.
- No cracks/fractures in crimp material or wire stranding
- Ensure symmetrical and uniform distribution of strands
- All strands are captured within crimp
- Crimp wings are fully closed at surface. Crimping wings are curled evenly and uniform
- The burr on the base of the crimp must not exceed 0.1mm, and will not scratch the sealing component in the next assembly process
- Crimping cross section criteria can be found in USCAR21as below

Conductor crimp attributes considered ideal

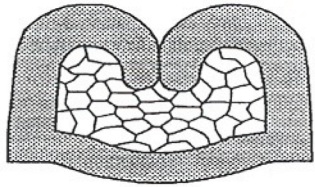

- Symmetric
- Compaction of all strands (no round strands)
- Wings touch only conductor
- Terminal stock free of cracks / breaks
- Core wings "Locked" (no gap) at top of crimp

Conductor crimp attributes considered acceptable but not ideal

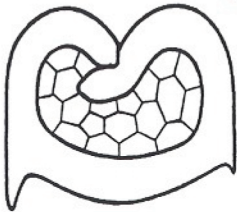

Overlapping wings



Extreme "ram-horning"

Conductor crimp attributes that are unacceptable*

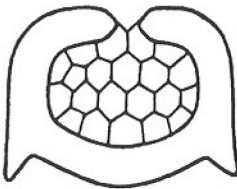

Open wings with core exposed or folded down into core but not touching (not locked)

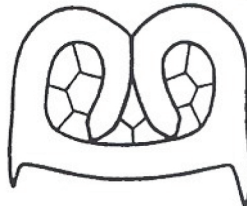

One or both wings penetrate ("crash") to the terminal floor or wall

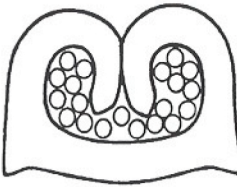

Low / No strand compaction. Round strands in core crimp are never acceptable

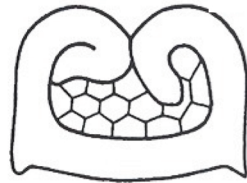

One or both wing details do not capture strands



Terminal stock cracked / broken

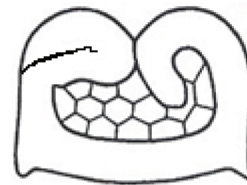

One or both wings folded back

4.5: Crimping Operation

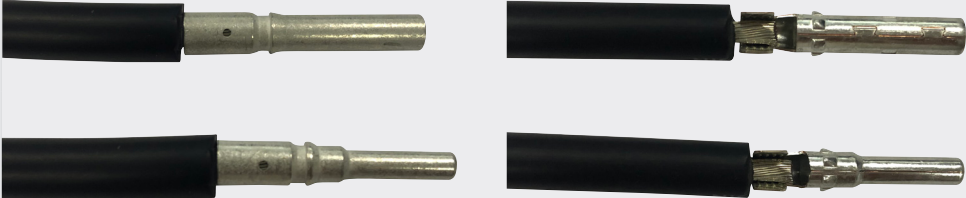
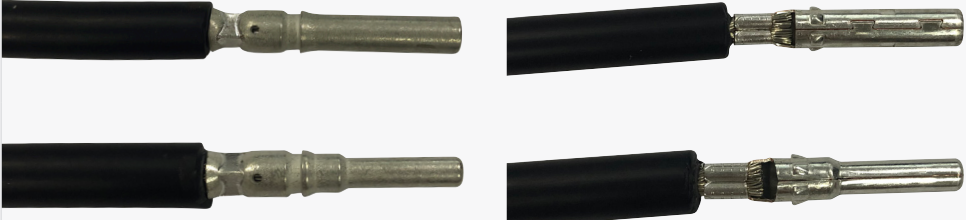
Process	Tools	Process Control
Stripping	H4TS0000	<p>Stripping Length 7.0 ± 0.5mm, don't damage or cut the wire strands.</p>  <p style="text-align: center;">$L = 7 \pm 0.5$mm</p>
Insert the cable into the contact	N/A	<ul style="list-style-type: none"> Put the contact at right crimping die and position. Insert striped cable into contact barrel and insure all conductor strands are captured in the contact barrel and the conductors are visible in the inspection hole for CF (cold formed) terminal. 
Crimping	UTXTC0003 UTXTC0004 UTXTC0005	<ul style="list-style-type: none"> Close the hand shank of the tool until they open automatically. Crimp to meet the requirements in section 4.4. Regularly check crimping height, and adjust the crimping force to get the perfect crimping quality. 

4.6: Crimping Tool Operation

1. Misuse may cause personal injury, keep crimper out of reach from children.
2. Do not insert fingers into the jaws of the tool.
3. Before using the crimper, clean the die to prevent oil or other chemical material from polluting the contact and connector.
4. Crimp tool and crimp dies are prone to wear, regularly check the quality of Crimping Height, pull out force. Tool and die wear can be compensated by removing the lock screw and turning the adjuster.

Part 5: Connector Assembly Process

5.1.1: Insert the Crimped Contact into the Body

Insert terminal into back of male or female connector. A “click” should be heard or felt when the terminal is seated in the right position. Terminals cannot be removed once seated (Terminals are crimped per tool application 3.2 to 3.4) See below pictures 5.1.1 to pictures 5.1.4.

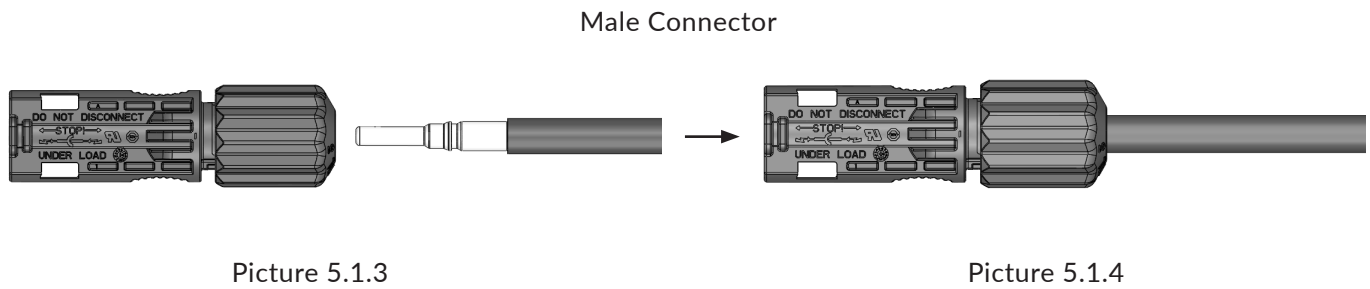
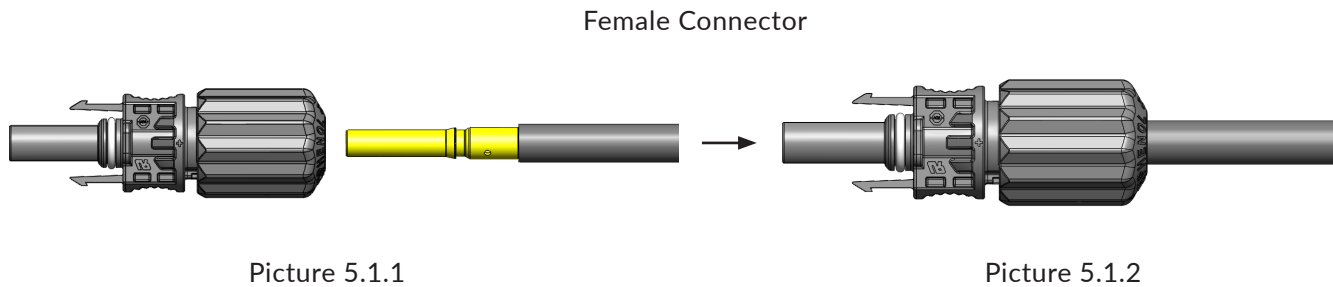

⚠ If the terminals are not inserted in the correct position, the connector itself will not be fully assembled, the contacts will not mate as intended, which will cause the connector to overheat and possibly cause a fire or safety risk.

Inspection

Use the contact depth inspection tool to check if the contact was in right position. The edge of connector housing should be located within the white area of the contact depth inspection tool.



5.1.2: Tightening the Back Cap

The Amphe-PV H4 Plus connector back cap must be screwed up with a proper torque range of 2.6 to 2.9 N-m.

- ⚠ Over torqueing may damage insulation on the cable, lead to a sealing failure and electrical leakage.
- Under torqueing may lead to a sealing failure, and compromise the reliability of the connector.

Action surface of connector, screw end cap and hold body of connector, as below picture 5.1.5.

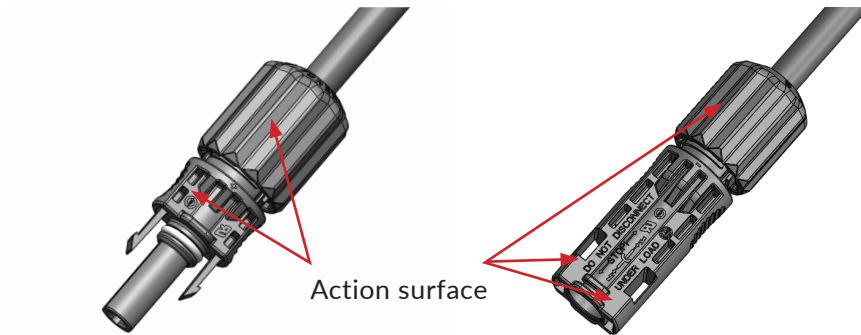

Picture 5.1.4

Amphenol specified wrench tool (H4TW0001) can be used in this step. Customer can choose to use open-end back cap spanner (Use H4TTW100) if customer uses electric torque controlled wrench tool to tighten the cap.

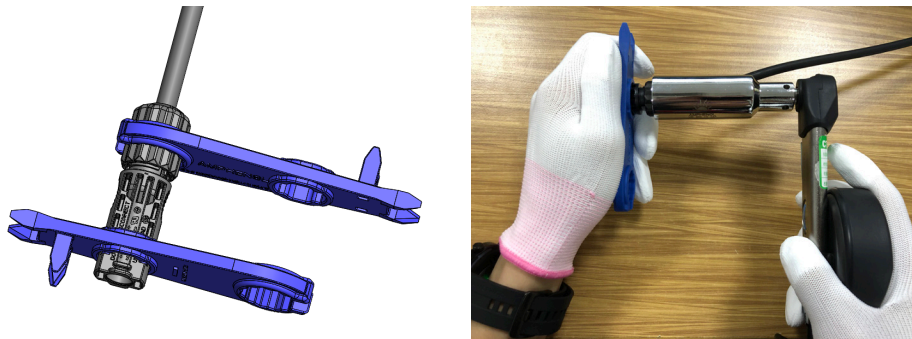

5.2: Panel Mounted End Assembly

5.2.1: Connector Assembly

Mount the connectors to the panel of inverter or converter, see picture 5.2.1.

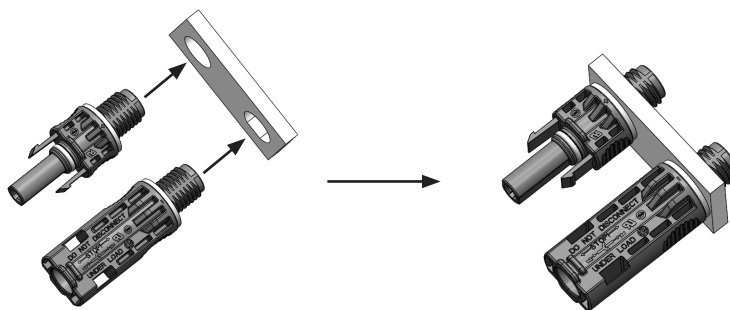

Picture 5.2.1

Use the wrench tool to tighten the nut to the panel, see picture 5.2.2. The nut must be screwed to a proper torque range of 1.1 to 1.4 N·m.

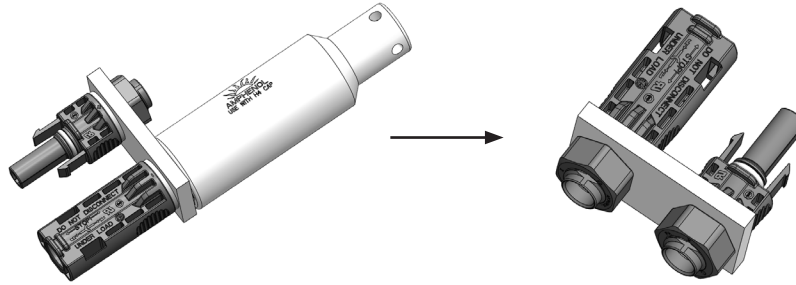

Picture 5.2.2

Insert terminal into back of male and female connector. A “click” should be heard or felt when the terminal is seated in right position. Terminals cannot be removed once seated.

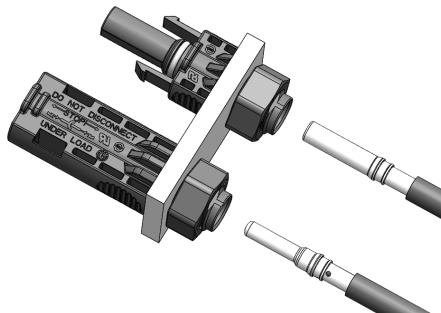

Picture 5.2.3

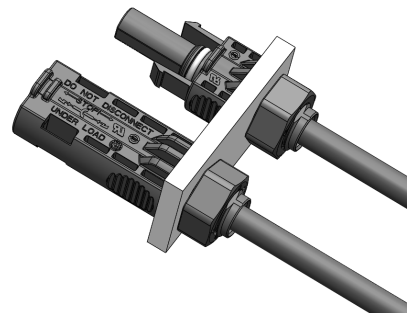

Picture 5.2.4



If the terminals are not inserted in the correct position, the connector itself will not be fully assembled, the contacts will not mate as intended, which will cause the connector to overheat and possibly cause a fire or safety risk.

Inspection

Use the contact depth inspection tool to check if the contact is in the right position. The edge of connector housing should be located within the white area of the contact depth inspection tool.



5.3: Protection before Mating



If the male and female connector is not inserted in a timely manner, measures should be taken to prevent dust, moisture, and other pollutants from the connector, that may result in terminal oxidation, or sealing failure.

Dust caps are recommended (female end use UTXPF and male end use UTXPM) for protection.

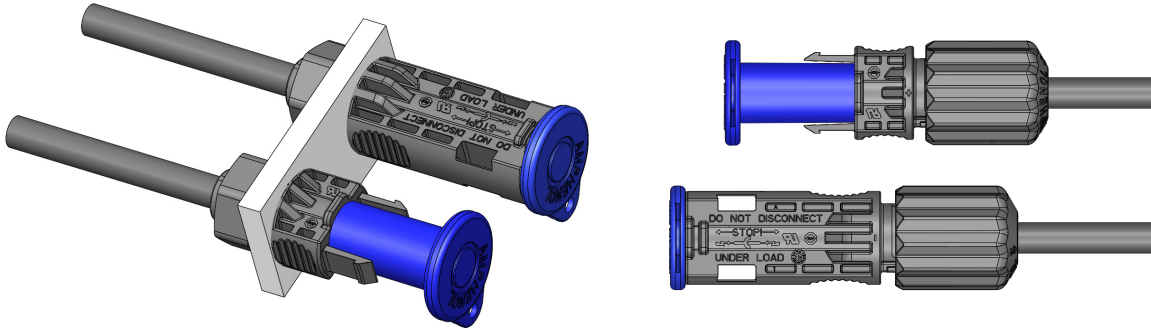

5.4: Mating the male and female connectors

After mating the male and female connectors, check the below items to confirm the male and female connectors were mated correctly.

1. The latch is engaged as below.
2. O-ring pressed inside and is not visible.
3. There is very small gap between the interface of male and female ($\text{gap} \leq 0.3\text{mm}$).

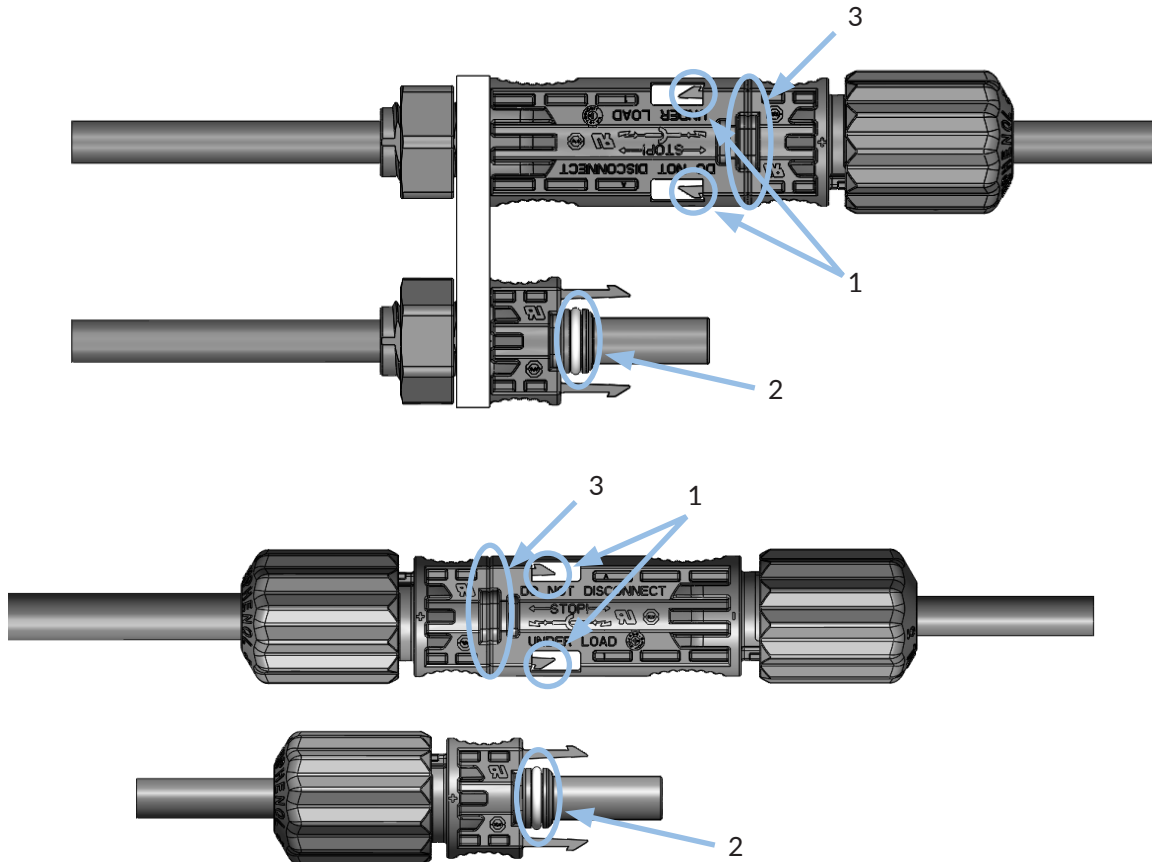

5.5: Un-mating the male and female connectors

Use the specified tool to open the connectors. Don't pull directly or shake the connector back and forth wildly to open the connector.

Amphenol specified wrench tool (H4TW0001) or Universal tool (H4TU0000) should be used in this step for the Amphe-PV H4 Plus Series, see below picture.

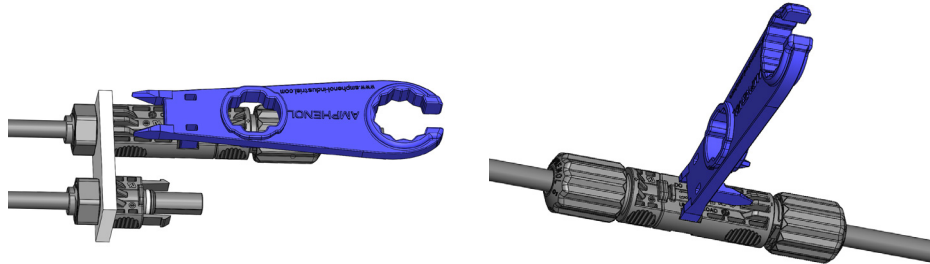

Wrench Tool Disconnect

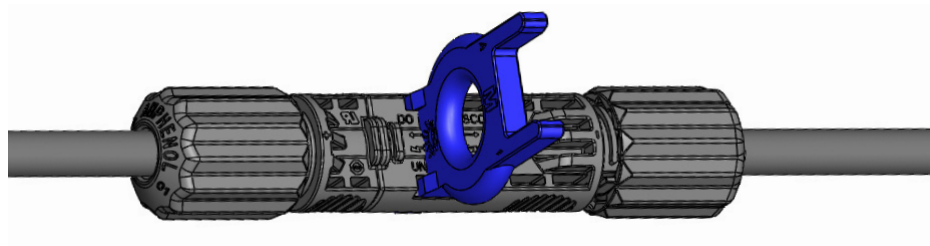

Universal Tool Disconnect

6: Cable Routing:

- The locking fixture of the Amphe-PV H4 Plus series can withstand pull forces of 89N min along the axial.

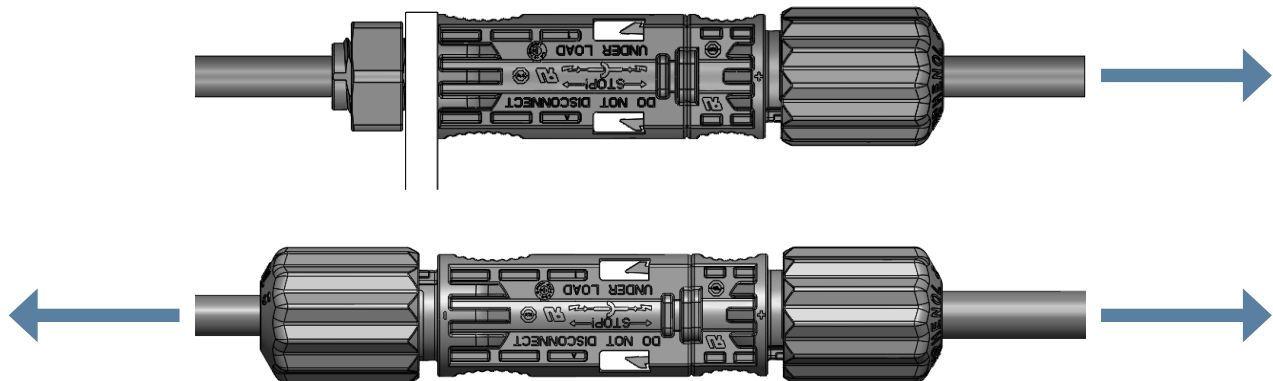

- External stress on the cable should be avoided; excessive cable stress along the axial for extended amounts of time; added cable stress and torque should be prohibited, and may impact sealing and reliability of the connector
- In order to avoid excessive cable stress to connector, the cable beside connector should be kept straight, straight cable length should be at least 20mm MIN.

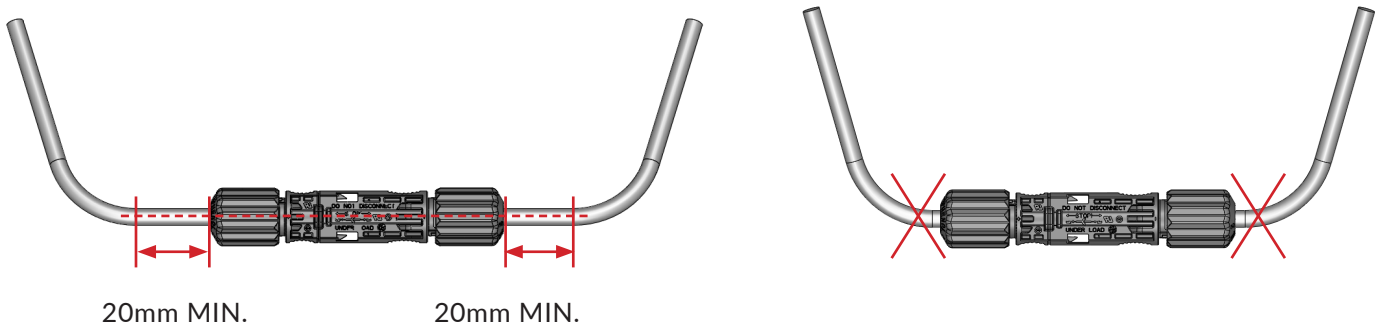

- Refer to cable manufacturer's specification for minimum bending radius of cable.

7: Storage Requirement

We recommend that you store connector components at a temperature between -30°C to +60°C and with a relative humidity of less than 70%. The components must not be exposed to moisture due to direct rainfall, condensation etc. Ensure that the individual components do not come into contact with acids, alkalis, gases, acetone or any other chemical substance that could impact the materials use. The connector can be stored for two years if these conditions are met.

8: Revision Record

Rev	Description	Date	Name
A	First Release	Apr/25/2021	Johnny Wang
B	Deleted Chemical List	Jun/30/2021	Johnny Wang
C	Added 8AWG Information	Jan/5/2022	Johnny Wang

(Prepared by) : _____

(Checked by) : _____

(Date) : _____

(Date) : _____

Amphenol Technology Shenzhen Ltd

Building C, 2nd Industrial Zone of Xia Shi Jia, Jiangshi Community, Gongming Sub-district, Guangming New District, Shenzhen, PRC CHINA

Tel: +86 755 2881 8389

Fax: +86 755 2991 83

Appendix A: Chemicals Exposure Check List

WI -S047-ENG

1. Applicable Products

Applies to H4 Series, Amphe-PV H4 Plus Series, UTX Series and PV cable assembly products.

2. Sensitive Chemicals List

WARNING



Amphenol warns customers and users to avoid exposure of chemical substances in the connector application environment. Chemical compatibility of thermoplastics e.g. Lexan polycarbonate is dependent on contact time, temperature, concentration and stress (external stress to which the application is subjected). Chemical exposure can result in discoloration, softening, swelling, cracking or loss of properties of the thermoplastics.

A list of chemicals known to avoid exposure is shown in the table below:

Classification	Chemical Name
Commonly used chemicals	Grease, Lubricate oil, Rust inhibitors, Stamping oil, Engine Oil, Banana Oil, WD-40, Insecticides, Oily sealing agent, Doduconta B25 Kontaktol, Chlorcosane, Evabrite S, Virex TB, Suma Lima L3, Suma Rinse Tableware Cleaner, plasticizer, Spray Cleaner 8188, Mold Clean Agent, Detergent, Herbicide
Grease	Molykote EM-50L(Dow Corning), Molykote PG-641(Dow Corning)
Oils	Die Cut(OELHELD), Machine Oil KV46(Nippon Oil)
Mold Release Agent	Pelicoat S-6(Chukyo-Kasei)
Binder	Chemlok(LORD)
Alcohols	Isopropyl alcohol(IPA)
Fatty Hydrocarbons	Heptane, Hexane, Cyclohexane, Liquid paraffin
Acid, Alkali, Salt	Salt acid, Sulfuric acid, Nitric acid, Phosphoric acid, Acetic acid, Ammonia, Sodium hydroxide
Halogenated Hydrocarbon	Freon, Carbon tetrachloride, Trichloromethane, Virex 256 Alkyl dimethyl ammonium chloride
Ketone	Acetone, Methyl ethyl ketone, Butanone, Ethyl methyl ketone oxime
Aromatic Hydrocarbon	Toluene, Xylene, Cresol, CRC Clean Solvent
Other, Organic Solvent	Ethyl acetate, Butyl acetate, Tributyl phosphate, Kerosene, Gasoline, Chloride, Varnish, Esters, Ethers, Amines, Glacial acetic acid, Print ink additive, 3M thinner
Adhesion Sealant	APF125(Wacker Chemical)
Potting Material	KE-200(ShinEtsu), CX-200(ShinEtsu)

Remarks:

1) The impact of chemicals on products can only be reflected in actual use. The chemicals listed in the above table are only obtained from the chemical compatibility of materials or the actual test in the laboratory. Sensitive chemicals include but are not limited to the above list. Amphenol will update the above list from time to time without notice. If necessary, you can contact the nearest Amphenol sales representative for it. Other chemicals that may be contacted or used in the manufacturing process and product installation process that are not in this list can be used only after the user confirms that they have no impact. For chemicals that cannot be determined by himself, please contact the sales or service representative of Amphenol. Amphenol does not accept any product return requirements caused by chemical pollution.

2) Some chemicals used in inverters (such as conformal coating, conformal coating thinner, sealant, silicone glue, etc.) contain volatile substances which have impacts on our products, and can result in corrosion, degradation or cracking. Amphenol suggests customer fully verify the manufacturing process to ensure the product is in a practical application.

3) Pesticides should not be applied directly or indirectly to connectors, it is recommended to use UV lamps for disinfection.