

GRÉPIN

REF 140.2.000 A

MAGNESIUM SAFETY KNIFE 4 IN 1

Ideal for all handling work: packing straps, cutting, tearing and plastic films.

SAFETY • A safety lock prevents the blade from coming out unexpectedly.

- The two blades cannot be used at the same time, a safety device allows to block one of the two blades.



DELIVERED WITH TWO
BLADES (ONE ROUNDED)



FOR RIGHT & LEFT
HANDED USERS



LIGHT



ERGONOMIC



SPRING RETRACTABLE
BLADE



SHOCK RESISTANT



RESISTANT TO DETERGENTS

1



SINCE
1904

TECHNICAL SHEET

MAGNESIUM: LIGHT AND RESISTANT

SAFETY: A SAFETY LOCK PREVENTS THE BLADE FROM COMING OUT UNEXPECTEDLY.

COMFORT: VERY LIGHT (65G).

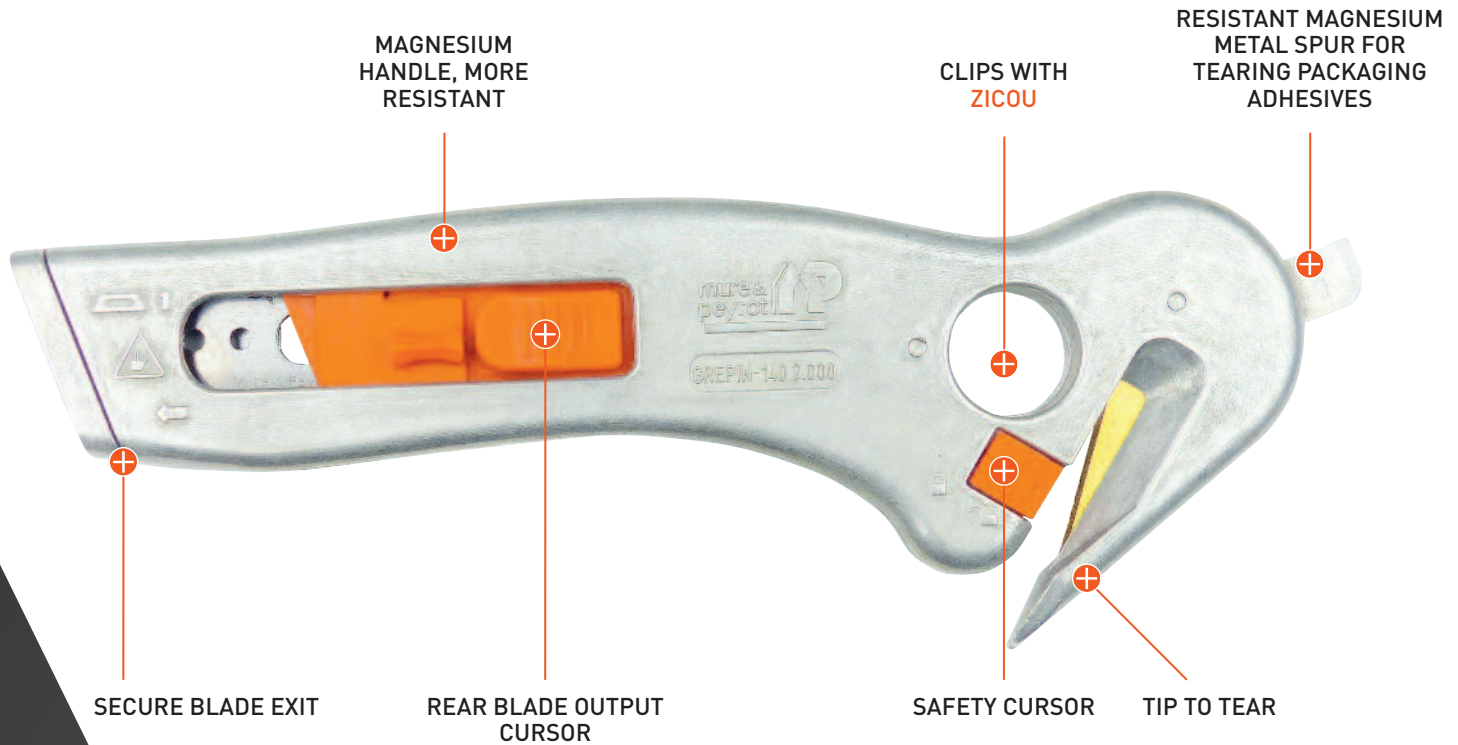

THE PROS



DELIVERED WITH A ROUNDED BLADE REF 152A.6



AND A STRAIGHT BLADE REF 789.3T



VERY RESISTANT AND LIGHT MAGNESIUM BODY (65 G)



ERGONOMIC AND LIGHT FOR RIGHT AND LEFT HANDED USERS

FUNCTIONS



For cutting single-groove cardboards



For cutting packaging adhesives



For cutting plastic films



For cutting thick plastic films, PVB



For cutting packaging links

MULTIFUNCTION SAFETY KNIFE

PACKING STRAPS, CUTTING, TEARING AND PLASTIC FILMS.



SAFETY KNIFE WITH SECURE BLADE EXIT

TECHNICAL CHARACTERISTICS

- Easy blade change.
- Reversible blade (152A.6).
- High cutting precision.
- Impact resistant.
- Detergents and acetone resistant.
- Easy to use for right and left handed.



BLADE CHANGE

01/The safety lock will free the rear blade.



02/Push the blade exit slider as far as it will go and lock it with the orange button.



03/Carefully remove the blade. To insert a new blade, proceed by reverse manipulation.



04/Unscrew the cover at the knife head.



Recommended tool

Pozidriv PZ1

05/Remove the cover. The blade stays in place.



06/Carefully remove the blade. To insert a new blade, proceed by reverse manipulation.

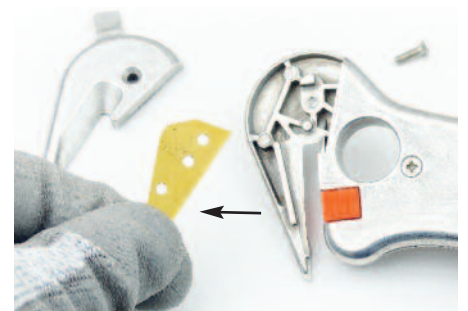

BLADES

DELIVERED WITH

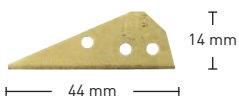

REF 789.3T THK 0,3 mm
Blade made of premium quality steel
TIN covered.

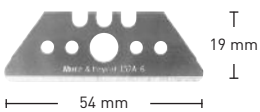

REF 152A.6 THK 0,6 mm
Blade made of premium quality steel.

OTHER COMPATIBLE BLADES

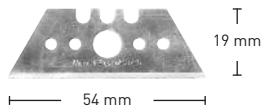

REF 152.6 THK 0,6 mm
Blade made of premium quality steel.

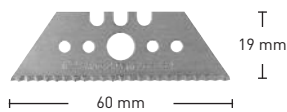

REF 653.6.1 THK 0,6 mm
Blade made of premium quality steel.

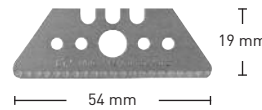

REF 652A.6.2 THK 0,6 mm
Blade made of premium quality steel.



REF 852A.7 AF Thk 0,7 mm
Ceramic blade.

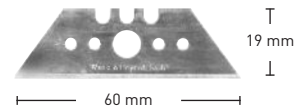

REF 153.6 THK 0,6 mm
Blade made of premium quality steel.

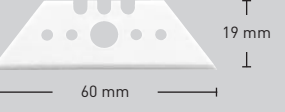

REF 853.7 AF Thk 0,7 mm
Ceramic blade.

Blade Reference	Description	Type	Dimensions (in mm) Length • Width • Thickness	Sharpening Angle	Hardness
789.3T	Straight blade	Premium quality steel TIN covered	44 x 15 x 0,3	17° - 34°	63,0 Hrc
152A.6	Straight blade with a rounded edge	Premium quality steel	54 x 19 x 0,6	18° - 27°	63,0 Hrc
152.6	Straight blade	Premium quality steel	54 x 19 x 0,6	18° - 27°	63,0 Hrc
652A.6.2	Straight blade with a rounded edge	Premium quality steel	54 x 19 x 0,6	15° - 28,5°	63,0 Hrc
153.6	Straight blade	Premium quality steel	60 x 19 x 0,6	18° - 28°	63,0 Hrc
653.6.1	Serrated straight blade	Premium quality steel	60 x 19 x 0,6	18° - 32°	63,0 Hrc
852A.7 AF	Serrated straight blade with a rounded edge	Ceramic	55 x 19 x 0,7	16°	-
853.7 AF	Straight blade	Ceramic	59 x 19 x 0,7	16°	-

TECHNICAL SHEET (in mm)

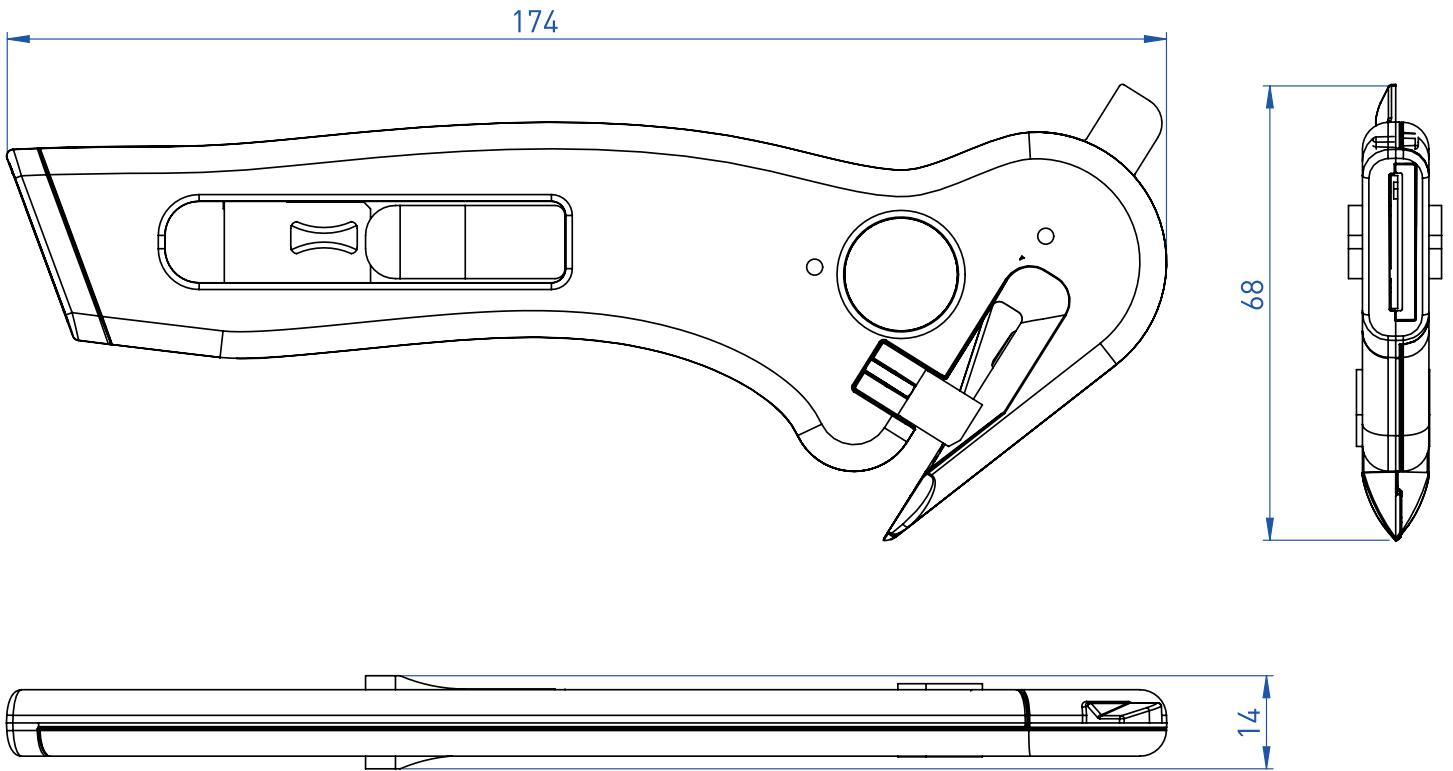

Packaging	Weight PKG	Dimensions (in mm) Length • Width • THK	Quantity PKG	Units	Accessories	Material	Color
SKIN PACK	65 g	174 x 68 x 14	10	4 units	Body	Magnesium	Metallic
					2 cursors	POM	Orange
					Spring	Stainless steel	Metallic
					Screw	Stainless steel	Metallic
					Blade 152A.6	Premium quality steel	Metallic
					Blade 789.3T	Premium quality steel TIN covered	Metallic yellow



MURE & PEYROT
 25, rue Roger Touton • BP 50120
 Parc d'Activités Bordeaux Nord
 33041 BORDEAUX CEDEX - FRANCE

Tél. : +33 (0)556 693 200 / Fax : +33 (0)556 693 202 / E-mail : mail@mure-peyrot.com

FOR MORE INFORMATION
MURE-PEYROT.COM