

## MERLOT 2

REF 134.2.000 A

### SAFETY KNIFE MULTI-PURPOSE "4 IN 1"

Ideal for all handling works and for opening cardboard boxes and packaging.

**SAFETY** • Blade automatically retractable.

\* A safety lock prevents the usage of both blades simultaneously.



DELIVERED WITH A  
ROUNDED EDGE BLADE

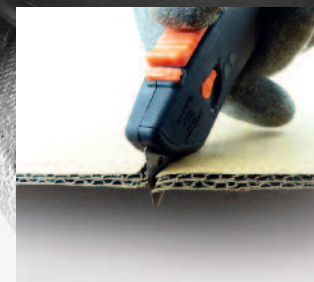

MAXIMAL  
SAFETY



LIGHT



FOR RIGHT AND LEFT  
HANDED USERS



AUTOMATIC RETRACTA-  
BLE BLADE BY SPRING



RESISTANT TO  
DETERGENTS

1



SINCE  
1904

# TECHNICAL SHEET

## TO CUT PLASTIC FILMS AND STRAPS, TO TEAR AND CUT PACKAGING

SAFETY: BLADE AUTOMATICALLY RETRACTABLE.

A SAFETY LOCK PREVENTS THE USAGE OF BOTH BLADES SIMULTANEOUSLY.



### THE PROS



DELIVERED WITH A ROUNDED EDGE BLADE REF 152A.6



AND A BLADE COVERED WITH TIN REF 789.3T

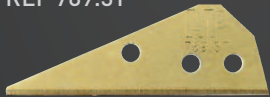

ERGONOMIC AND LIGHT FOR RIGHT AND LEFT HANDED USERS



HIGH CUTTING PRECISION

### FUNCTIONS



To cut single and double-wall carton



To cut packaging adhesives



For cutting flexible plastics, PVB



To cut plastic films



To cut threads and strings



To cut packaging links

#### ENHANCED SECURITY

TO USE THE BLADE AT THE BACK, LOCK THE BLADE AT THE FRONT.



#### ENHANCED SECURITY

LOCK AND LATCH TO UNLOCK THE REAR BLADE TO CHANGE IT.



#### OTHER CHARACTERISTICS

- Robust and very light (70g).
- User comfort.
- Easy blades change.

## BLADE CHANGE

**01**/Easily release the flap by sliding it out.

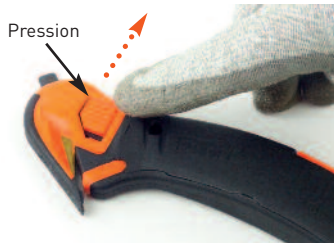

**01**/Turn the small latch on the side by a quarter turn.



**04**/Carefully remove the blade.

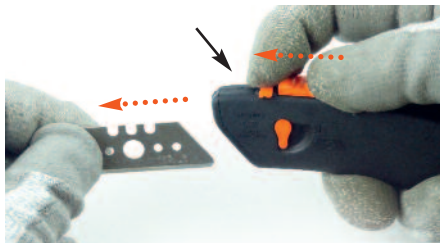

**02**/Remove the cover.



**02**/Push the cursor as far as it will go.



**05**/Hold the small lock and slider fully to insert a new blade.

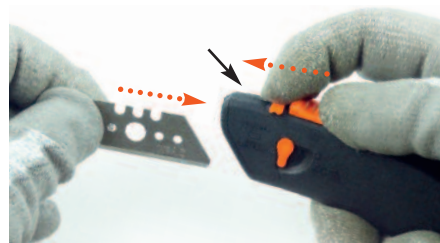

**03**/Carefully remove the blade.



**03**/Holding the cursor fully down, slide the small lock to one side.



**06**/The push button will return to its original position. Turn the latch a quarter turn to block the blade exit.



## BLADES

### DELIVERED WITH

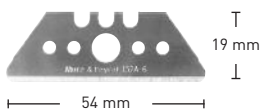

**REF 152A.6** Thk 0,6 mm  
Blade made of premium quality steel.

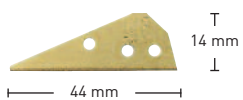

**REF 789.3T** Thk 0,3 mm  
Superior TIN steel blade.

### DELIVERED WITH

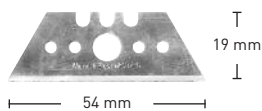

**REF 152.6** Thk 0,6 mm  
Blade made of premium quality steel.

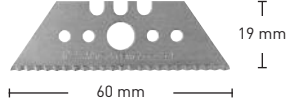

**REF 653.6.1** Thk 0,6 mm  
Blade made of premium quality steel.

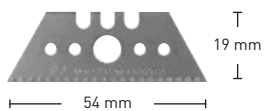

**REF 652.6.2** Thk 0,6 mm  
Blade made of premium quality steel.

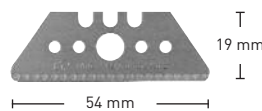

**REF 652A.6.2** Thk 0,6 mm  
Blade made of premium quality steel.

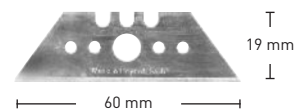

**REF 153.6** Thk 0,6 mm  
Blade made of premium quality steel.

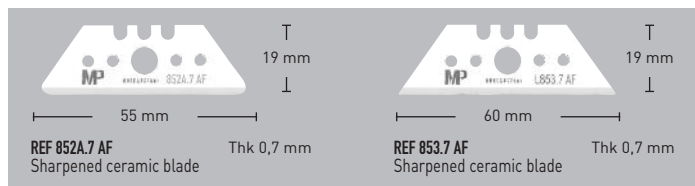

**REF 852A.7 AF** Thk 0,7 mm  
Sharpened ceramic blade

**REF 853.7 AF** Thk 0,7 mm  
Sharpened ceramic blade

Blade reference	Description	Type	Dimensions (in mm) Length • Width • Thickness	Sharpening angle	Hardness
152A.6	Lame droite avec bout arrondi	Acier supérieur	54 x 19 x 0,6	18° - 27°	64,0 Hrc
789.3T	Lame droite	Acier supérieur revêtue TIN	44 x 15 x 0,3	17° - 34°	63,0 Hrc
152.6	Lame droite	Acier supérieur	54 x 19 x 0,6	18° - 27°	64,0 Hrc
652.6.2	Lame droite dentée	Acier supérieur	54 x 19 x 0,6	15° - 28,5°	64,0 Hrc
652A.6.2	Lame droite dentée avec bout arrondi	Acier supérieur	54 x 19 x 0,6	15° - 28,5°	64,0 Hrc
153.6	Lame droite	Acier supérieur	60 x 19 x 0,6	18° - 28°	64,0 Hrc
653.6.1	Lame droite dentée	Acier supérieur	60 x 19 x 0,6	18° - 32°	64,0 Hrc
852A.7 AF	Sharp trapezoidal blade with rounded tip	Zirconia ceramics	54 x 19 x 0,7	16°	-
853.7 AF	Sharp trapezoidal blade	Zirconia ceramics	60 x 19 x 0,7	16°	-

## TECHNICAL SHEET (in mm)

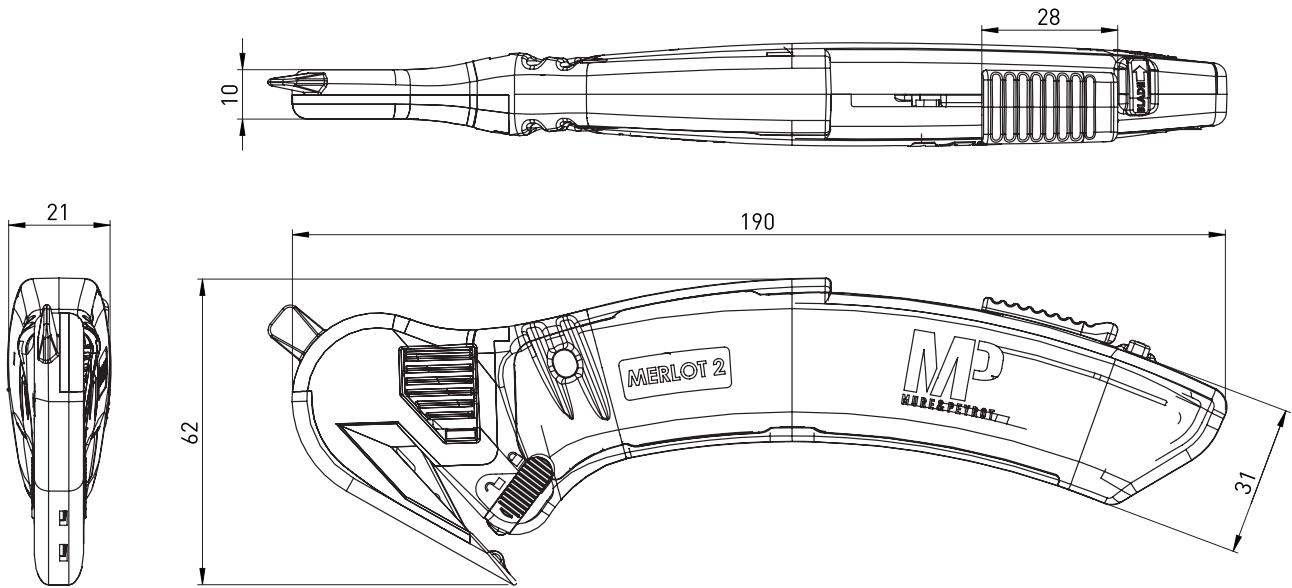

Packaging	Weight PKG	Dimensions (in mm) Length • Width • Thick.	Quantity PKG	Units	Accessories	Material	Colors
SKIN PACK	70 g	190 x 61 x 20	10	14 units	Body	PA6 GF30	Grey
					Cover	PA6 GF30	Grey
					Blade-Holder	POM	Grey
					Connecting rod	POM	Grey
					Beak cover	POM	Orange
					Chariot	POM	Orange
					Chariot's tap	POM	Grey
					Latch	POM	Orange
					Cover locker	POM	Orange
					Trapeze blade locker	POM	Orange
					Spring Blade holder	Stainless Steel	Metal grey
					Spring Chariot	Stainless Steel	Metal grey
					Blade 152A.6	Premium Quality Steel	Metal grey
Blade 789.3T	Superior TIN steel blade.	Metal grey					

**MP**  
MURE & PEYROT

MURE & PEYROT  
25, rue Roger Touton • BP 50120  
Parc d'Activités Bordeaux Nord  
33041 BORDEAUX CEDEX - FRANCE

Tel.: +33 (0)556 693 200 / Fax: +33 (0)556 693 202 / E-mail: mail@mure-peyrot.com

FOR MORE INFORMATION  
[MURE-PEYROT.COM](http://MURE-PEYROT.COM)