

MERLOT

REF 134.2.000 A

SAFETY KNIFE MULTI-PURPOSE "4 IN 1"

Ideal for all handling works and for opening cardboard boxes and packaging.

SAFETY • Blade automatically retractable.

* A safety lock prevents the usage of both blades simultaneously.



DELIVERED WITH A ROUNDED
EDGE BLADE



MAXIMAL
SAFETY



LIGHT



ERGONOMIC



FOR RIGHT AND LEFT
HANDED USERS



AUTOMATIC RETRACTA-
BLE BLADE BY SPRING



RESISTANT TO
DETERGENTS

TECHNICAL SHEET

TO CUT PLASTIC FILMS AND STRAPS, TO TEAR AND CUT PACKAGING

SAFETY: BLADE AUTOMATICALLY RETRACTABLE.

A SAFETY LOCK PREVENTS THE USAGE OF BOTH BLADES SIMULTANEOUSLY.

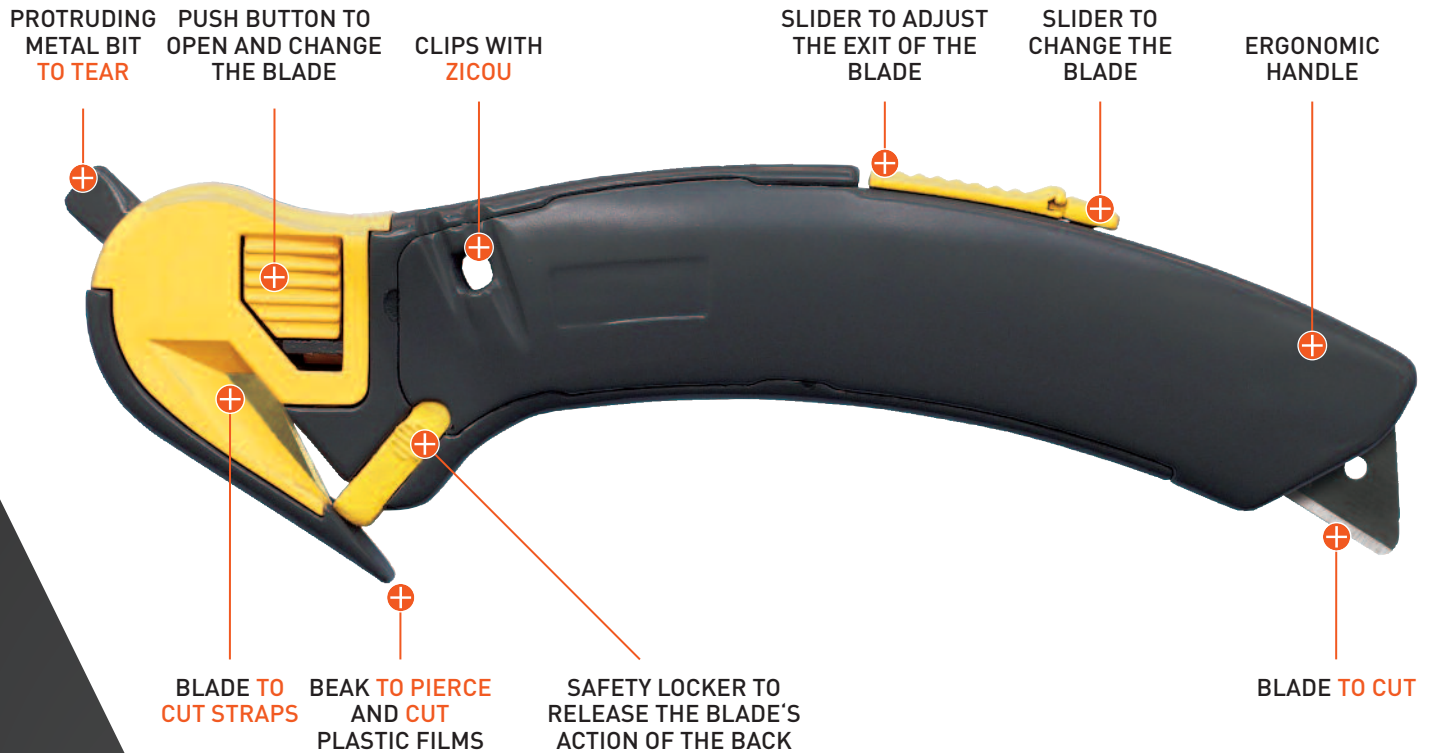

THE PROS



DELIVERED WITH A ROUNDED EDGE BLADE REF 152A.6



AND A BLADE COVERED WITH TIN REF 789.3T

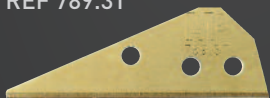

ERGONOMIC AND LIGHT FOR RIGHT AND LEFT HANDED USERS



HIGH CUTTING PRECISION

FUNCTIONS



To cut single-wall carton



To cut packaging adhesives



To cut thick plastic films, PVB



To cut plastic films



To cut threads and strings



To cut packaging links

ENHANCED SECURITY

TO USE THE BLADE AT THE BACK, LOCK THE BLADE AT THE FRONT.



OTHER CHARACTERISTICS

- Robust and very light (70g).
- User comfort.
- Easy blades change.

BLADE CHANGE

01/Locking (optional).



02/ Push on the button to release the cover of the beak.



03/ Take out the blade carefully. To introduce a new blade, proceed the reverse manipulation.



01/ Push the slider to take out the blade at most.



02/ Push the button



03/ Remove carefully the blade. To introduce a new blade, proceed the reverse manipulation.

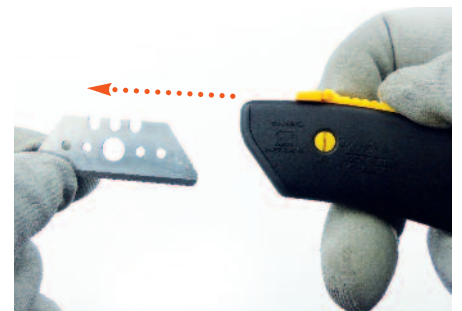

BLADES

DELIVERED WITH

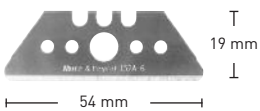

REF 152A.6 Thk 0,6 mm
Blade made of premium quality steel.

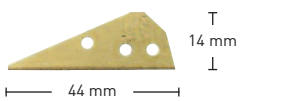

REF 789.3T Thk 0,3 mm
Blade made of premium quality steel covered with TIN.

DELIVERED WITH

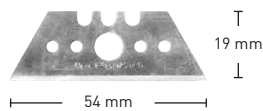

REF 152.6 Thk 0,6 mm
Blade made of premium quality steel.

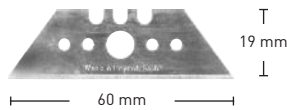

REF 153.6 Thk 0,6 mm
Blade made of premium quality steel.

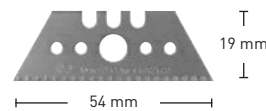

REF 652.6.2 Thk 0,6 mm
Blade made of premium quality steel.

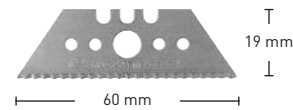

REF 653.6.1 Thk 0,6 mm
Blade made of premium quality steel.

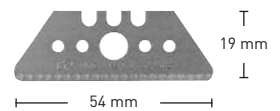

REF 652A.6.2 Thk 0,6 mm
Blade made of premium quality steel.

Blade reference	Description	Type	Dimensions (in mm) Length • Width • Thickness	Sharpening angle	Hardness
152A.6	Straight blade with a rounded edge	Premium quality steel	54 x 19 x 0,6	18° - 27°	64,0 Hrc
789.3T	Straight blade	Premium quality steel covered with TIN	44 x 15 x 0,3	17° - 34°	63,0 Hrc
152.6	Straight blade	Premium quality steel	54 x 19 x 0,6	18° - 27°	64,0 Hrc
652.6.2	Serrated straight blade	Premium quality steel	54 x 19 x 0,6	15° - 28,5°	64,0 Hrc
652A.6.2	Serrated straight blade with a rounded edge	Premium quality steel	54 x 19 x 0,6	15° - 28,5°	64,0 Hrc
153.6	Straight blade	Premium quality steel	60 x 19 x 0,6	18° - 28°	64,0 Hrc
653.6.1	Serrated straight blade	Premium quality steel	60 x 19 x 0,6	18° - 32°	64,0 Hrc

TECHNICAL SHEET (in mm)

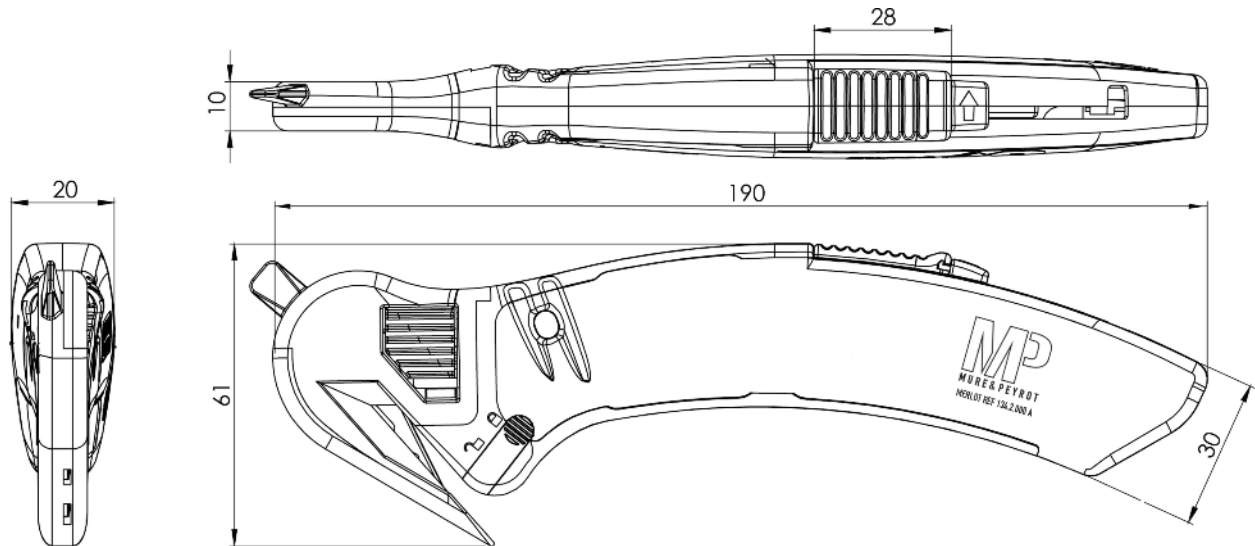

Packaging	Weight PKG	Dimensions (in mm) Length • Width • Thick.	Quantity PKG	Units	Accessories	Material	Colors
SKIN PACK	70 g	190 x 61 x 20	10	16 units	Body	PA6 Glass fiber	Grey
					Cover	PA6 Glass fiber	Grey
					Blade-Holder	POM (Polyoxymethylene)	Grey
					Connecting rod	PA6 Glass fiber	Grey
					Beak cover	POM (Polyoxymethylene)	Yellow
					Chariot	POM (Polyoxymethylene)	Yellow
					Chariot's tap	POM (Polyoxymethylene)	Grey
					Latch	POM (Polyoxymethylene)	Yellow
					Cover locker	POM (Polyoxymethylene)	Yellow
					Trapeze blade locker	POM (Polyoxymethylene)	Yellow
					Superior locker	POM (Polyoxymethylene)	Yellow
					Inferior locker	POM (Polyoxymethylene)	Yellow
					Spring Blade holder	Stainless Steel	-
					Spring Chariot	Stainless Steel	-
					Blade 152A.6	Premium Quality Steel	Metal grey
					Blade 789.3T	Premium Quality Steel	Metal grey

Patented design.

MP
MURE & PEYROT

MURE & PEYROT
25, rue Roger Touton • BP 50120
Parc d'Activités Bordeaux Nord
33041 BORDEAUX CEDEX - FRANCE

Tel.: +33 (0)556 693 200 / Fax: +33 (0)556 693 202 / E-mail: mail@mure-peyrot.com

FOR MORE INFORMATION
MURE-PEYROT.COM